

LA-UR-16-20816

Approved for public release; distribution is unlimited.

Title: Stormwater Pollution Prevention Plan TA-3-38 Metals Fabrication Shop
Los Alamos National Laboratory

Author(s): Burgin, Jillian E.

Intended for: Regulatory Compliance Document
Environmental Programs

Issued: 2016-02-10

Disclaimer:

Los Alamos National Laboratory, an affirmative action/equal opportunity employer, is operated by the Los Alamos National Security, LLC for the National Nuclear Security Administration of the U.S. Department of Energy under contract DE-AC52-06NA25396. By approving this article, the publisher recognizes that the U.S. Government retains nonexclusive, royalty-free license to publish or reproduce the published form of this contribution, or to allow others to do so, for U.S. Government purposes. Los Alamos National Laboratory requests that the publisher identify this article as work performed under the auspices of the U.S. Department of Energy. Los Alamos National Laboratory strongly supports academic freedom and a researcher's right to publish; as an institution, however, the Laboratory does not endorse the viewpoint of a publication or guarantee its technical correctness.

STORMWATER POLLUTION PREVENTION PLAN

TA-3-38 Metals Fabrication Shop

Los Alamos National Laboratory

A requirement of the
NPDES MULTISECTOR GENERAL PERMIT # NMR053915 (LANS)
for Storm Water Discharges Associated with Industrial Activities

Prepared by:
Los Alamos National Laboratory
Environmental Protection Division
ENV-CP (Water Quality & Storm Water)
PO Box 1663 MS K490
Los Alamos, New Mexico 87545

Revision 1: January 2016

TA-3-38 Metals Fabrication Shop
STORMWATER POLLUTION PREVENTION PLAN
TABLE OF CONTENTS

TABLE OF CONTENTS ii
PREFACE iv

SECTION 1: FACILITY DESCRIPTION AND CONTACT INFORMATION..... 1

- 1.1 Facility Description and Contact Information..... 1
- 1.2 Stormwater Pollution Prevention Teams..... 1
- 1.3 Site Description/Industrial Activities 2
- 1.4 General Location Map 2
- 1.5 Site Map 3

1.6 OUTFALLS 3

SECTION 2: POTENTIAL POLLUTANT SOURCES..... 4

- 2.1 Potential Pollutants Associated with Industrial Activity 4
- 2.2 Spills and Leaks 5
- 2.3 Non-Stormwater Discharges Documentation 6
- 2.4 Salt Storage..... 7
- 2.5 Sampling Data Summary..... 7

SECTION 3: STORMWATER CONTROL MEASURES 8

- 3.1 Minimize Exposure 8
- 3.2 Good Housekeeping..... 9
- 3.3 Maintenance 9
- 3.4 Spill Prevention and Response 9
- 3.5 Erosion and Sediment Controls..... 10
- 3.6 Management of Runoff..... 10
- 3.7 Salt Storage Piles or Piles Containing Salt 11
- 3.8 Dust Generation and Vehicle Tracking of Industrial Materials 11
- 3.9 MSGP Sector-Specific Non-Numeric Effluent Limits..... 11
- 3.10 Numeric Effluent Limitations Based on Effluent Limitations Guidelines..... 12
- 3.11 Water Quality Based Effluent Limitations and Water Quality Standards 12
- 4.1 Good Housekeeping..... 13
- 4.2 Maintenance 13
- 4.3 Spill Prevention and Response Procedures..... 13
- 4.4 Erosion and Sediment Control 13
- 4.5 Employee Training 13
- 4.6 Stormwater Monitoring 14
- 4.6.1 Monitoring Schedule..... 15
- 4.6.2 Substantially Identical Outfalls 15
- 4.6.3 Monitoring Requirements 15
- 4.6.4 Monitoring Results..... 17
- 4.6.5 Recordkeeping 17

SECTION 5: INSPECTIONS AND CORRECTIVE ACTIONS..... 17
5.1 Routine Facility Inspection Procedures..... 17
5.2 Quarterly Visual Inspection Procedures..... 19
5.3 Corrective Actions Process 19
5.4 Conditions Requiring Review to Determine if Modifications Are Necessary..... 20
**SECTION 6: DOCUMENTATION TO SUPPORT ELIGIBILITY CONSIDERATIONS UNDER OTHER
FEDERAL LAWS..... 21**
6.1 Documentation Regarding Endangered Species..... 21
6.2 Documentation Regarding Historic Properties..... 21
6.3 Documentation Regarding NEPA Review..... 22
SECTION 7: SWPPP CERTIFICATION 23
SECTION 8: SWPPP MODIFICATIONS 24

APPENDIX A: Stormwater Pollution Prevention Team Members
APPENDIX A1: Stormwater Pollution Prevention Team Meeting Notes
And other documentation relative to the SWPPP
APPENDIX B: Site Maps
APPENDIX C: NOI and LANS Delegation of Authority Letter
APPENDIX D: Non Storm Water Discharge Certification
APPENDIX E: SWPPP Amendment Log
APPENDIX F: Facility Inspections:
Monthly Routine Inspection Form
Quarterly Visual Assessment Form
Completed Inspection Reports
APPENDIX G: Spill Tracking Table
APPENDIX G1: Spill Report Form Template and Completed Spill Reports
APPENDIX H: Storm Water Monitoring Records and Results (Current Permit)
APPENDIX H1: Sampling Data from Previous Permit Term (MSGP 2008)
APPENDIX I: Records of Employee Training Related to the SWPPP
APPENDIX J: Corrective Action Reports
APPENDIX J1: Documentation of Repairs and Maintenance of Control Measures
APPENDIX K: Critical Habitat Documentation for LANL
APPENDIX L: Procedures Referenced in the SWPPP

TA-3-38 Metals Fabrication Shop
STORMWATER POLLUTION PREVENTION PLAN
TABLE OF CONTENTS

PREFACE

This Storm Water Pollution Prevention Plan (SWPPP) was developed in accordance with the provisions of the Clean Water Act (33 U.S.C. §§1251 et seq., as amended), and the Multi-Sector General Permit for Storm Water Discharges Associated with Industrial Activity (U.S. EPA, June 2015) issued by the U.S. Environmental Protection Agency (EPA) for the National Pollutant Discharge Elimination System (NPDES) and using the industry specific permit requirements for Sector AA-Fabricated Metal Products as a guide. The applicable stormwater discharge permit is EPA General Permit Registration Number NMR053915 (Los Alamos National Security (LANS) (U.S. EPA, June 2015). Contents of the June 4, 2015 Multi-sector General Permit can be viewed at: http://water.epa.gov/polwaste/npdes/stormwater/upload/msgp2015_finalpermit.pdf

This SWPPP applies to discharges of stormwater from the operational areas of the TA-3-38 Metals Fabrication Shop at Los Alamos National Laboratory. Los Alamos National Laboratory (also referred to as LANL or the "Laboratory") is owned by the Department of Energy (DOE), and is operated by Los Alamos National Security, LLC (LANS). Throughout this document, the term "facility" refers to the TA-3-38 Metals Fabrication Shop and associated areas. The current permit expires at midnight on June 4, 2020.

A copy of the facility NOI and LANS Delegation of Authority Letter are located in Appendix C of this SWPPP.

SECTION 1: FACILITY DESCRIPTION AND CONTACT INFORMATION

1.1 Facility Description and Contact Information

The Metals Fabrication Shop (MFS) is located in Technical Area 3, Building 38 (TA-3-38) at the southeast corner of West Jemez and Pajarito Road within Los Alamos National Laboratory, in Los Alamos County, New Mexico.

Facility Operator: Los Alamos National Security, LLC
Los Alamos National Laboratory
Environmental Protection Division
ENV-CP (Water Quality & Stormwater)
PO Box 1663 MS K490
Los Alamos, NM 87545
Phone: 505-667-0666

Facility Contacts: Holly Wheeler, MSGP Compliance Project Lead
Environmental Protection, Environmental Compliance Programs (ENV-CP)
Office: 505-667-1312
Email: hbenson@lanl.gov

Jillian E. Burgin, MSGP Environmental Technical Advisor
Deployed Environmental Professional, CISEC
Office: 505-665-1893
Email: jburgin@lanl.gov

Other applicable facility data and contact information is provided in the facility NOI, which is located in Appendix C of this SWPPP. The NOI provides the coordinates of the facility and also a link to the online location where this SWPPP can be viewed.

1.2 Stormwater Pollution Prevention Teams

The TA-3-38 MFS is part of LANL's Utilities and Infrastructures (UI) Facilities Operations Directorate (FOD) with day-to-day management provided by the Logistics Division Central Shops (LOG-CS); which has established a Stormwater Pollution Prevention Team (PPT) whose members are responsible for assisting the facility manager in developing and revising the facility's SWPPP as well as maintaining control measures and taking corrective actions when required. All PPT members will have access to either a hard copy or an electronic version of this SWPPP. A list of PPT members along with duties and contact information is provided in Appendix A of this SWPPP.

Designation of Pollution Prevention Teams

The Stormwater PPT for the TA-3-38 MFS consists of operations and management personnel from the facility, a representative from ENV-CP, and a Deployed Environmental Professional (DEP). The ENV-CP representative is responsible for Laboratory compliance under the National Pollutant Discharge Elimination System (NPDES) permit regulations. The team members are selected on the basis of their familiarity with the activities at the facility and the potential impacts of those activities on stormwater runoff.

The specific duties of individual team members of the PPT are listed below and in Appendix A

- **Pollution Prevention Team Leader:** The Pollution Prevention Team Leader is identified in Appendix A of this SWPPP. The Team Leader or designated representative will assist ENV-CP and/or the DEP in performing routine inspections as described in Section 5.2 of this SWPPP. The Team Leader or designated representative will also ensure that the appropriate facility and other LANS personnel receive the training as specified in Section 3.8 of this SWPPP.
- **Team Members:** Other members of the team are responsible for the implementation of this SWPPP and the required periodic inspections, as described in Section 5 of this SWPPP. In the event of a spill or release, a team member will ensure that prompt cleanup occurs and will incorporate documentation of the spill and cleanup process into the Spill Tracking Table located in Appendix G of this SWPPP. Team members will also be selected to assist/represent the Team Leader in performing routine, annual and visual site inspections.
- **ENV-CP Project Leader:** Supports the facility and provides guidance associated with implementation of the compliance requirements identified in the 2015 MSGP. The ENV-CP Project Leader also acts as the institutional point of contact for all interactions with the regulatory authority (EPA) and supervises personnel that implement monitoring requirements for the facility.
- **Environmental Technical Advisor/Deployed Environmental Professional (DEP):** Responsible for SWPPP updates and conducting routine facility inspections and entering corrective actions into the Corrective Action Report (CARs) Database. The Environmental Technical Advisor/DEP is also responsible for tracking and updating the status of corrective actions that cannot be implemented immediately.
- **All Members:** All PPT members are responsible for being familiar with and implementing this SWPPP and for compliance with the 2015 MSGP.

1.3 Site Description/Industrial Activities

The industrial activities at this site may be classified under **Sector AA – Fabricated Metal Products**. The primary operation of the TA-3-38 MFS is to fabricate metal components for a variety of uses around the Laboratory. All metal fabrication at the shop is performed indoors.

Outdoor activities at the facility consist of:

- Metal storage in designated yard areas, metal pipe racks and metal-for-recycle bins
- Shop vehicle and equipment (i.e. forklift) parking
- Loading and unloading fabricated metal materials and associated products at the loading docks/bays

Industrial activities and major structures at the facility are shown on the Site Map in Appendix B, Figure B-3.

The facility contains various shops: including a machine shop, sheet metal shop, pipe fitter's shop, and ironworker's shop (including high bay and low bay) that are housed in the north end of Building 38. Other operational areas associated with the facility include: loading docks on the west, southwest and east sides of Building 38, an enclosed storage area in Building 37- Room 106 used for storing machine oil, and outdoor metal storage areas and scrap metal bins located on the west and east sides of Building 38. The remainder of Building 38 houses Laboratory personnel in either office settings or shops that are not associated with this facility and its industrial activities.

1.4 General Location Map

The general location map for the facility can be found as Figure B-1 in Appendix B. The map is a 2011 fly over that provides a general/regional location of the facility. Figure B-2 in Appendix B provides locations of all receiving waters associated with stormwater discharges from the facility.

1.5 Site Map

A site map provided in Appendix B, Figure B-3 illustrates the facility's activities: including property boundaries, structures, impervious surfaces, operational areas as well as information on drainage patterns, stormwater and erosion control structures, potential pollutant sources, and nearby receiving streams.

As required by the 2015 MSGP, the following information specific to the facility is shown either on the site map or with additional information provided in this SWPPP.

- **Site Boundaries and Acreage.** The site covers approximately 1.83 acres
- **Significant Structures and Impervious Surfaces.** The site is 100% impervious, primarily structures and paved lots.
- **Direction of Stormwater Flow and Site Drainage.** Direction of flow is indicated with arrows.
- **Locations of Structural Stormwater Control Measures.**
- **Locations of all Receiving Waters.** In the immediate vicinity of the facility, indicating if any of the waters are Impaired and, if so, whether the waters have TMDLs established for them (see paragraph below this list). A map of nearby receiving waters is provided in Appendix B-2.
- **Locations of all Stormwater Conveyances.** This includes all ditches, pipes, and swales.
- **Locations of Potential Pollutant Sources.**
- **Locations of Significant Spills or Leaks.**
- **Locations of all Stormwater Monitoring Points.**
- **Locations of Stormwater Inlets and Outfalls.** Of which each will require a unique identification code for each outfall (e.g., Outfall #002, etc), indicating if you are treating one or more outfalls as "substantially identical" and an approximate outline of the areas draining to each outfall.
- This facility is not associated with a municipal separate storm sewer system (MS4)
- **Areas of designated critical habitat for endangered or threatened species.** There are none in the direct vicinity of the facility. However, a map for threatened and endangered species within LANL property is included in Appendix B-4.
- There are no non-stormwater discharges at the facility (see certification in Appendix D)
- Locations of the following activities where such activities are exposed to precipitation:
 - fueling stations (none at this facility)
 - vehicle and equipment maintenance and/or cleaning areas (none at this facility);
 - loading/unloading areas;
 - locations used for the treatment, storage, or disposal of wastes;
 - liquid storage tanks (none at this facility);
 - processing and storage areas;
 - immediate access roads and rail lines used or traveled by carriers of raw materials, manufactured products, waste material, or by-products used or created by the facility;
 - transfer areas for substances in bulk;
 - machinery; and
 - locations and sources of run-on to your site: West Jemez Road and Bikini Atoll Road are paved roads and the parking areas west of the facility are sources that contribute run-on that contains significant quantities of pollutants.

1.6 Outfalls

Outfall #002: Consists of three grated drop inlets located west of Building 38 that discharge to a single corrugated metal pipe. Stormwater flows through the facility to the outfall where automated samples are collected. The discharge pipe runs south from the facility, through TA-3 and daylights east of Building 261.

Substantially Identical Outfalls

Outfall #002 is the sole outfall for this facility. Discharge is to Sandia Canyon.

SECTION 2: POTENTIAL POLLUTANT SOURCES

2.1 Potential Pollutants Associated with Industrial Activity

Most industrial activities at the TA-3-38 MFS occur indoors so materials are not exposed to stormwater. Potential stormwater pollutants associated with this facility involve materials stored outdoors: primarily finished or scrap metals or metal shavings with the possibility of containing residual cutting oils; and associated outdoor activities such as loading/unloading materials at shop bays and vehicle/forklift parking. Controls used for each potential pollutant are described in Section 3 of this SWPPP.

The primary metal storage yard (located on the southwest side of the outdoor lot) is enclosed with a chain link fence and locked gate. The metal storage yard contains five covered metal storage racks and a covered metal for recycle storage bin, which temporarily stores metal scrap metal. Large pieces of scrap metal are also stored within the metal storage yard on wooden pallets. This metal is kept covered with heavy-duty (28 mil.) tarps. Located on the north side of the outdoor lot there is also a covered garbage dumpster and covered cardboard recycle dumpster. A covered pipe storage rack is also located outdoors on the northwest side of the iron worker's shop that belongs to the pipe fitters. Machine oil is stored on secondary containment units within TA-3-37 Room 106, which is a fully enclosed storage building and is not exposed to stormwater. A second covered metal-for-recycle bin is located on the southeast side of Building 38, outside of the pipefitter's shop at Room 104, and is used to recycle metal scraps brought in from pipefitting and other fieldwork.

Vehicle parking is limited to areas adjacent to the east boundary fenceline and west of Building 38. Forklifts are parked inside and occasionally outside on the west end of Building 38. Loading docks and bays on the west and southwest side of the facility are primarily used to transport metal stock or finished metal products to and from the shop. The loading docks on the east side of the facility are not used to receive or transport materials, and there is no outdoor storage of materials in this area. The parking lot on the east side of the facility is utilized by other tenants of Building 38 and is not exclusively for the TA-3-38 MFS.

Activities in the Area exposed to Stormwater:

- **Metal Stockpile/Storage Yards (Covered Metal Storage Racks):** Potential pollutants include: metals exposed to precipitation (rust).
- **Covered Metal-for-Recycle Storage Bins:** Potential pollutants include: processed metal shavings, turnings, small metal scraps, and cutting oil residues (if leakage occurred from container).
- **Pipe Storage Rack (Covered Metal Storage Rack):** Potential pollutants include: metal pipe exposed to precipitation (rust).
- **Vehicle Parking:** Potential pollutants include: the leakage of fuel, oil, or hydraulic fluids.
- **Forklift Storage:** Potential pollutants include: the leakage of fuel, oil, or hydraulic fluids.
- **Trash & Cardboard Dumpsters (Enclosed):** Potential pollutants include: trash, debris, plastics, food and cardboard, which can get blown around the parking lot or carried out of the dumpster by birds or other wildlife.

Solid Waste Management Units (SWMUs)

There is one SWMU located within the facility boundary located at the southeast corner of the west (primary) metals storage yard. It is not included as part of the LANL NPDES or Individual Permit (IP) for SWMUs at the Laboratory covered under Sector K.

SWMU 03-013(i) consists of soil and gravel contaminated from historical releases of hydraulic oil at the former locations of Buildings 3-246 and 3-247, which were used to test the tensile strength of various steel cables used in conjunction with underground nuclear test assemblies. The facility was constructed prior to 1967 and was operated until the mid-1980s when a replacement facility was constructed on Sigma Mesa. Building 3-246 was a corrugated metal building constructed on a concrete slab and contained the controls for the pull test equipment, as well as a hydraulic oil compressor and storage tank. Building 3-247 was a corrugated metal building constructed on a concrete curb surrounding a gravel floor and contains two hydraulic rams used to perform the tensile strength testing. Hydraulic oil was provided to the rams through underground pipes between Buildings 3-246 and 3-247. The contamination identified at SWMU 03-013(i) consisted of oil-stained soil around Building 3-246 and oil-stained gravel inside Building 3-247. At the former location of Building 3-246, hydraulic oil appears to have been released to the concrete slab floor inside the building and to have subsequently flowed beneath the building walls and onto the soil surrounding the building. Visible soil contamination existed along the north side of the building and along the northeast and northwest corners. The gravel floor inside Building 3-247 was visibly stained with oil in several locations beneath the hydraulic ram assembly.

NOTE: Both Buildings 3-246 and 3-247 were decommissioned and removed during the summer of 2004. While they are no longer present, SWMU 03-013 (i) was established to monitor and remediate spills that did occur while those two buildings were used to house test equipment.

SWMU 03-013(i) was not included in the 1990 SWMU Report or the OU1114 RFI Work Plan, but was discovered in 2004 during planning for the demolition of Buildings 03-246 and 03-247. Two samples of the oil-stained soil adjacent to the former location of Building 03-246 were collected by the Laboratory's Solid Waste Regulatory Compliance Group in 2004 and analyzed for inorganic chemicals, organic chemicals, PCBs, and total petroleum hydrocarbons (TPH). Four inorganic chemicals (cadmium, copper, lead, and zinc) were detected above BV, but below SALs. TPH was also detected, but no organic chemicals or PCBs were detected. Oil-stained soil was removed when the two buildings were demolished and confirmation samples were collected by the ER Project. This SWMU is being proposed for no further action (NFA) and is not a potential pollutant of concern in regard to the TA-3-38 MFS.

2.2 Spills and Leaks

Past Spills and Leaks

05/2007 (07a): TA-3-38 parking lot (NW corner at roofing project staging area). One pint of engine oil resulting from a forklift leak was discovered. The LANS contractor (KSL ES&H) reported the spill. All oil was absorbed and the waste generated was removed and disposed of properly. The Contractor removed the leaking piece of equipment from the site.

09/2007 (07b): TA-3-38 parking lot (NW corner at roofing project staging area). The leaking tar container belonged to a roofing contractor that was replacing the roof of Building 38. Tar from the container leaked through the parking lot to the east and onto the MFS boundary. Metals Fabrication staff placed a pig mat around the storm drain closest to the leak in order to prevent tar from entering the storm drain. KSL ES&H reported the spill and it was promptly cleaned up by the roofing contractor.

09/2008 (08): TA-3-38 west of the pipe fitter's shop (leaking compressor). The spill was contained, cleaned, and spill pans were placed under the compressor and associated piping. Additionally, the petroleum contaminated soil associated with the leak was remediated and disposed. The compressor was also removed from the facility.

09/2015 (15a): TA-3-38 metal storage yard (leaking roll-off bin). The metals roll-off bin was being removed from the yard when it leaked a small amount of water mixed with cutting oil. EM&R responded and remediated the spill. The roll-off bin was permanently removed from the yard.

10/2015 (15b): TA-3-38 east of metal storage yard (fire extinguisher discharge). Powder from an inadvertent fire extinguisher discharge was found in the west parking lot area during a SWPPP inspection. EM&R responded and remediated the area.

10/2015 (15c): TA-3-38 north side of building (water with oil sheen discharged from trench drain). Approximately 10-20 gallons of water (with oil sheen) was released from the trench drain sump pump to the north side of the building. The water is normally discharged to prevent flooding to the pipe fitter's shop below. However, paving of the parking lot during the year caused an oily sludge to accumulate in the trench drain. The area was remediated with Microblaze and a Petro Plug (oil barrier) was installed on the pipe end to prevent oil from being discharged when the water is released. The trench drain was also cleaned out.

Potential Spills and Leaks

Table 1: Areas of Site Where Potential Spills/Leaks Could Occur:

LOCATION	OUTFALLS (see site map)
Covered Recyclable Metal Scrap Storage Bin	#002
Vehicle Parking	#002
Forklift Storage	#002
Loading and Unloading Operations	#002
Machine Oil Storage Area, Bldg. 37, Rm. 106	Oil drums and containers are indoors and also on secondary containment – not exposed to stormwater.

In the event of any future spill or leak at any of the facility areas, Appendix G will be revised to reflect the occurrence and the nature of the spill or leak. The revision should be performed immediately upon the completion and documentation of the spill response and cleanup.

The probability of spills or releases at the facility is minimized by the application of good housekeeping procedures and appropriate operational methods. These operational procedures include drum dollies and drum grapplers on the forklifts used for unloading and reloading operations. Spill containment and clean-up supplies are located in Room 125 of the TA-3-38 MFS and absorbent material for oil clean-up is located throughout the shop in metal containers.

Appropriate response measures for a spill or release of hazardous materials are applied when addressing spills. The specific spill response and cleanup procedures will depend on the nature of the spilled material. Specific response techniques for spills involving all water priority chemicals will be performed as required by section 8.AA.2.2 of the 2015 MSGP. Specific spill response and reporting procedures for LANL are listed in Section 3.4 of this SWPPP.

2.3 Non-Stormwater Discharges Documentation

Except for flows from fire-fighting activities, sources of non-stormwater that are combined with stormwater discharges associated with industrial activity will be identified in the SWPPP.

Non-stormwater discharges are also identified in the "Non-Stormwater Discharge Assessment and Certification" in Appendix D. This form certifies that all stormwater outfalls have been evaluated for the presence of non-stormwater discharges. This form will be updated whenever a change in possible non-stormwater discharge is determined.

There are no NPDES permitted non-stormwater discharges or unpermitted outfalls associated with the facility. Potential sources of non-stormwater discharges at the facility include the testing of fire hydrants in the area. Both the jet and plasma-arc cutting machines inside of the MFS are plumbed to discharge into floor drains in the low bay, which at one time were connected to the storm drain system. Occasionally water used during hydrostatic testing of equipment is discharged into floor drains in the pipefitter's shop in the high and low bays. Since all floor drains have been rerouted to the sanitary sewer, there is no impact to stormwater discharges from these activities. The shop floor drains are temporarily plugged when not in use.

Fire hydrant testing is performed periodically on hydrants servicing the facility. The hydrants are located at the corner of Pajarito and West Jemez Roads, at the corner of Pajarito and Parry Roads, on Parry Road adjacent to TA-3-1518, and at the fence line east of TA-3-38. All of these hydrants are located outside of the facility boundary and are therefore not considered sources of non-storm water discharge.

2.4 Salt Storage

No salt storage or piles containing salt are present at the facility. When or if salt storage activities do occur at the site, the SWPPP will be amended to address the requirements.

2.5 Sampling Data Summary

Sampling of stormwater runoff from the facility is currently performed by the ENV-CP, Water Quality and Stormwater Group. Samples are collected at an automated monitoring station #03-0038W located adjacent to and west of TA-3-38 at Outfall #002.

Review of analytical results from the previous permit term (MSGP 2008) indicates that zinc exceeded its benchmark parameter in multiple sampling events during the 2008 permit coverage. Benchmark exceedances do not constitute a permit violation. However, monthly sweeping has been implemented at the facility, which has been shown (through monitoring results) to reduce zinc concentrations in stormwater runoff. In 2011, aluminum and iron exceeded benchmark and copper exceeded impaired waters parameters. However, these exceedances were solely attributed to natural background in stormwater.

Results from sampling data for the current permit term (MSGP 2015) will be kept on file in Appendix H of this SWPPP. Sampling data from the previous permit term (MSGP 2008) are provided in Appendix H1.

SECTION 3: STORMWATER CONTROL MEASURES

3.1 Minimize Exposure

Control measures at the facility are designed to minimize the potential for spills, releases, exposure of materials, or any other events that could adversely affect the quality of water and sediment that may be transported out of the area by stormwater runoff.

Proper material management and storage minimize the potential for exposure of precipitation and runoff to potentially hazardous materials. Containers that could be susceptible to spillage or leakage will be plainly labeled (e.g., "Used Oil," "Spent Solvents," etc.). Most operations and storage areas are located within structures, so that the potential for exposure of stormwater to potential pollutants is limited to the outdoor metal storage areas, vehicle and forklift parking areas, and loading areas. Adequate secondary containment is provided for outdoor storage units containing potentially hazardous materials. Heavy equipment repair and maintenance is performed offsite. Metal cutting and fabrication activities occur inside.

Specific Structural Controls Description:

- **Covered Metal-for-Recycle Storage Bins**
Metal shavings, turnings, and scraps are stored inside covered roll-off bins which are emptied (for recycling) on a routine basis.
- **Covered Metal and Pipe Storage Racks**
Metal scrap, pipe and finished/fabricated metal parts are stored on elevated racks to prevent direct contact with stormwater runoff. Where it is not feasible to store metal materials on covered racks (due to size, weight, etc.), the metal is stored off-ground on pallets and covered with sturdy, 28 mil tarps that are manufactured to last 25 years.
- **Vehicle Parking Area**
Large trucks and passenger car parking is sporadic and not confined to one area. Areas are inspected for leaks and oil absorbent is available for containment if needed.
- **Forklift Storage**
Forklifts are parked inside on most occasions to reduce the potential for exposure to stormwater. Maintenance on forklifts is performed off site at the Heavy Equipment shop. Regular inspections are conducted to identify all leaking equipment and oil absorbent is readily available.
- **Petro-Pipe Oil Barrier**
The Petro-Pipe oil barrier is installed at the end of the drain pipe that discharges excess stormwater from the trench drain/sump pump outside of the pipefitter's shop. The Petro-Pipe prevents any oil (that may be accumulated in the trench drain) from being discharged to the parking lot and Outfall #3. Pumping of the trench drain is required in order to prevent flooding of the adjacent shop. The Petro-Pipe is removed during winter months to prevent damage from inclement weather, snow removal and vehicle traffic.
- **Asphalt Berming (Run-on Control)**
The asphalt berming along Bikini Atoll Road and West Jemez Road prevents stormwater run-on to the site from adjacent roadways.

3.2 Good Housekeeping

Good housekeeping practices specifically applicable to the prevention of stormwater contamination include the following measures:

All site areas exposed to precipitation are walked down weekly and during monthly inspections to ensure that the grounds are kept in an orderly condition. The outdoor metal storage areas are inspected to ensure all pipe is off the ground on storage racks, large scrap metal is elevated and stored on pallets or contained inside a recycling bin and small scrap metal including shavings and turnings are contained inside a covered recycling bin. Vehicle and forklift parking areas are inspected for leaks or spills and the entire site areas including the loading areas are inspected for floatable debris, garbage, waste and all other potential pollutants. The metal for recycle bins are monitored by facility personal and emptied for recycling on a routine basis. The roll-off bins will be kept covered when not in use. Trash dumpster lids will be kept closed when not in use.

3.3 Maintenance

Control measures at the facility will be kept in effective operating condition. If control measures need to be replaced or repaired, necessary modifications will be made according to the timelines specified in the Corrective Action requirements of Section 5.4 of this SWPPP. Documentation of maintenance and repair of control measures (BMPs) will be kept on file in Appendix J1 of the SWPPP. Deficient items identified during monthly or other routine facility inspections will be documented on the inspection forms and must be corrected within the same time frame as noted above.

The PPT Leader is responsible for ensuring that any maintenance or repairs associated with a deficiency or opportunity for improvement, including any regular or scheduled maintenance (such as the removal of debris) are promptly and adequately performed. Any necessary changes to operational procedures or structural features must be implemented in a timely manner before the next rain event.

Structures used for management of stormwater and sediment at the facility include the asphalt swale and rock lined channel along the eastern boundary, and the grated subsurface drains indicated on the site map. These controls are inspected to ensure that they are not obstructed by debris and that any maintenance or repair of the structure must be performed promptly and adequately before the next rain event.

Facility personnel are responsible for the performance of routine maintenance on process equipment used inside the facility. Absorbent pads or material is placed under machinery leaking oil. Malfunctioning machinery is immediately taken out of service until repairs can be made.

3.4 Spill Prevention and Response

Spill Prevention consists of: Spills, leaks, or releases that are minimized by the application of good housekeeping procedures, best management practices (BMPs), and engineering and administrative controls. Examples of these measures include storing equipment with drip pans, and inspecting regularly for leaks. Containers that could be susceptible to spillage or leakage will be plainly labeled (e.g., "Used Oil," "Spent Solvents," etc.) to encourage proper handling and facilitate rapid response if spills or leaks from these containers should occur. Spill cleanup materials (absorbent pads) are located in Room 125 at the TA-3-38 MFS and absorbent material for shop oil cleanup is located in metal containers throughout the shop.

In general, the approach to spill cleanup is to secure the spill area and contact ENV-CP at 667-0666 and the Security and Emergency Operations (SEO) Emergency Management & Response (EM&R) Team (if necessary). For incidental releases, absorbents are used to pick up free liquids and the contaminated absorbents are properly disposed.

The SEO or Facility Duty Officer shall report all spills or releases. All uncontrollable spills or releases must be reported to the SEO/EM&R Office or Facility Duty Officer by calling 667-6211 or, after hours, at 667-7080. If fire or explosion is present, or if the potential for such exists, the situation must be reported by dialing 911 from a non-cellular phone or by activating a fire pull box. In the event of a spill, the SEO/EM&R Office will determine appropriate cleanup procedures and will notify the individuals or organizations responsible for completing spill reports or fulfilling regulatory reporting requirements. An emergency trailer with spill cleanup and safety equipment ready for rapid transport to any part of the Laboratory is available at TA-63.

The completion of a spill report (form provided in Appendix G-1) is also required in the event of a spill. The spill report will be submitted to ENV-CP personnel and handled according to internal spill record keeping procedures. Spills may be "reportable" (requiring external agency notification) depending on the nature of the spilled material and the location of the release. External agency notification may consist of verbal or written notification to the National Response Center, Environmental Protection Agency Region VI, or the New Mexico Environment Department (NMED). The determination for the type of reporting will be made by the SEO/EM&R Office, and ENV-CP in accordance with Laboratory and DOE policies and federal and state regulatory reporting requirements. Copies of internal spill reports are maintained by the responsible organization. If an un-reportable spill occurs it will be documented in the spill log in Appendix G.

Additional ENV-CP procedures (documents provided in Appendix L) for spill reporting and response include:

- ENV-CP-QP-007, Spill Investigations:
<http://int.lanl.gov/training/v-courses/41819/41819.pdf>; and
- ENV-DO-QP-101.2, Environmental Reporting Requirements for Releases or Events:
<http://int.lanl.gov/training/env-courses/42415/env-do-qp-101.pdf>

3.5 Erosion and Sediment Controls

The entire outside surface region associated with the facility, except for small plots of grass adjacent to the buildings, is paved with asphalt and concrete; therefore, erosion and sediment transport is unlikely. An asphalt swale and rock lined channel located along the east boundary fence manage structural runoff and reduce the potential for slope erosion in that area. An asphalt berm along Bikini Atoll Road and West Jemez Road prevents run-on to the facility from adjacent roadways. Sweeping of the west lot at the facility is performed monthly, except during winter months when weather conditions do not permit.

3.6 Management of Runoff

The majority of stormwater runoff from outdoor activity areas at the facility is captured by one of 4 grated storm drains located on site. In the event of a stormwater backup at the grated (trench) drain west of the pipefitter's shop, a sump-pump will discharge stormwater inside the facility, along the north fence line and adjacent to West Jemez Road. This is necessary to prevent the pipefitter's shop from flooding.

Run-on from offsite parking flows east into the on-site grated storm drains, which are located on the west side of Building 38. As a result of grading modification, parking lot runoff does not impact the southwestern portion of the metal storage yard.

All subsurface drains are positioned correctly to capture storm water runoff from all activity areas including: metal storage, pipe storage, forklift, and vehicle parking. All subsurface drains are grated and inspected for obstruction during monthly inspections. All onsite and offsite storm drains at the facility connect to a common storm system and common outfall which daylight into a tributary of Sandia Canyon.

See site map in Figure B-3, Appendix B or Outfall information provided in Sections 1.5 and 4.2 of this SWPPP for more detailed information on drainage patterns and control measures associated with this facility.

3.7 Salt Storage Piles or Piles Containing Salt

There are no salt storage areas or piles containing salt present at the facility. When or if salt storage activities do occur at the site, the SWPPP will be amended to address the requirements.

3.8 Dust Generation and Vehicle Tracking of Industrial Materials

The entire outside surface region associated with the facility, except for small plots of grass adjacent to the buildings, are paved with asphalt and concrete. Therefore, dust generation at the facility is minimal and dust suppression is not required. All metal cutting and fabrication activities occur inside. Metal scrap and shavings are put into a transfer bin inside the machine shop and is then taken outdoors to the metal scrap bins for recycling. The Environmental Technical Advisor PPT member will be responsible for assuring that off-site tracking of raw, final or waste materials are enforced. The PPT Leader is responsible for making sure the outdoor ground areas (especially around scrap metal bins) are free of metal scraps and shavings.

3.9 MSGP Sector-Specific Non-Numeric Effluent Limits

Part 8 of the 2015 MSGP identifies sector-specific requirements for **Sector AA – Fabricated Metal Products** in addition to the numeric limits outlined in this Section. The facility must comply with requirements associated with the primary industrial activities described in Section 1.3 of this SWPPP and any co-located industrial activities as defined in Appendix A of the 2015 MSGP. The sector specific requirements only apply to those areas of the facility where the sector-specific activities occur.

The following Sector-Specific Non-Numeric Effluent Limits are addressed at this facility:

- **Raw Steel Handling Storage:** The majority of handling and all fabrication/processing occurs inside the metal fabrication shop. All shavings, turnings, and iron dust resulting from fabrication activities are contained in receptacles below each piece of machinery. Receptacles are emptied into bins located throughout the fabrication shop. Metal shavings from full bins inside the shop as well as larger metal scraps are emptied into the outside covered metal-for-recycle bins located in the northwest fenced yard. Scrap metals from pipefitter and other miscellaneous fieldwork are placed in the covered metal-for-recycle bin located outdoors at the east side of the pipefitter's shop at 3-38, Room 104. Excess piping and other metals are either placed on covered elevated racks or on pallets covered with tarps in the northwest metals storage yard or on the covered pipefitter's racks on the north side of the facility. No wastes are disposed on site.
- **Metal Fabricating Areas:** All areas are enclosed and maintained daily to ensure all shaving, turning, and iron dust is contained. Areas around all machinery are swept and inspected daily for spills. Oil absorbent for dry clean-up is readily available in the event of leakage, and all hydraulic shear and rolling machines are equipped with equipment shields.
- **Storage Areas for Raw Metal:** The outside metal storage areas including the covered metal storage racks inside the metal storage yard, northwest metal storage area, and the covered pipe storage rack are maintained in a neat, orderly state. Raw metal shavings and turnings stored outside are contained inside the covered roll off which is emptied offsite. Raw metal shavings and turnings stored inside are contained in proper receptacles and spill kits are labeled and readily accessible.

- **Metal Working Fluid Storage Area:** Cutting and drilling oils used at the facility are stored in Building 37, Room 106. The room is fully enclosed and drums are additionally stored within secondary containment. There is no exposure of this area to stormwater.
- **Cleaners and Rinse Water:** All rinse water and cleaners are located or stored inside to prevent stormwater contamination. Floor drains have either been closed or rerouted to the sanitary sewer system.
- **Lubricating Oil and Hydraulic Fluid Operations:** All operations occur inside to prevent stormwater contamination. In the case of temporary outdoor storage, secondary containment will be utilized for lubrication oils in 55 gallon drums. Metal-for-recycle bins are covered to prevent stormwater from contacting metal shavings containing cutting oil residues.
- **Chemical Storage Areas:** Any chemicals (including paints) used in the shop are kept stored indoors and inside of flammable cabinets if necessary. Chemical items are labeled appropriately and are inventoried annually through LANL's Chemlog (barcode) tracking system.
- **Spills and Leaks:** A detailed description of spill prevention and response procedures is included in section 3.4. The probability of spills or releases at the facility is minimized by the application of good housekeeping procedures and appropriate operational methods. These operational procedures include drum dollies and drum grapplers on the forklifts used for unloading and reloading operations. Appropriate response measures for a spill or release of hazardous materials are applied when addressing spills. The specific spill response and cleanup procedures will depend on the nature of the spilled material. Specific response techniques for spills involving water priority chemicals will be performed as required by section 8.AA.2.3 of the MSGP. Spill containment and clean-up supplies are labeled, maintained and located at all of the facility's operational areas.
- **Roll-Off Bins and Trash Dumpsters:** will be kept covered when not in use. If covers are not available, an alternate control measure (such as secondary containment) will be implemented to prevent discharge of stormwater from these containers.

3.10 Numeric Effluent Limitations Based on Effluent Limitations Guidelines

The TA-3-38 MFS is classified under **Sector AA-Fabricated Metal Products** and does not meet the industrial category requirements for effluent monitoring as listed in Part 2.1.3 (*Table 2-1 Applicable Effluent Limitations Guidelines*) of the 2015 MSGP. Benchmark monitoring is performed at the facility and those requirements and parameters are listed in Section 4.6 of this SWPPP.

3.11 Water Quality Based Effluent Limitations and Water Quality Standards

Impaired Receiving Waters/TMDLs

Impaired waters monitoring is performed annually at the facility as listed in Section 4.6.3 of this SWPPP.

The TA-3-38 MFS Outfall #002 discharges to Sandia Canyon (Sigma Canyon to NPDES outfall 001). Certain stream reaches within Sandia Canyon have been identified as impaired waters by the NMED Surface Water Quality Bureau (SWQB). According to the 2014-2016 State of NM Clean Water Act 303b/305b Integrated Report and Final List of Assessed Surface Waters, pollutants causing the impairment are listed as: *Gross Alpha, adjusted; Aluminum, PCB in water column; Copper, and Thallium, dissolved*. Primary potential pollutant sources have been identified as post development erosion/sedimentation and urban runoff (NMED 2014). TA-3-38 MFS operations do not involve the impaired water pollutants of concern. EPA has not yet approved or established TMDLs for Sandia Canyon.

SECTION 4: SCHEDULES AND PROCEDURES

4.1 Good Housekeeping

All site areas exposed to precipitation, including outfalls, will be walked down weekly and during monthly inspections to ensure that the grounds are kept in an orderly condition. All areas will be inspected for floatable debris, garbage, waste and all other potential pollutants. Trash and debris will be picked up and disposed of in the covered trash dumpster.

The cardboard recycle and trash dumpsters will be emptied weekly or bi-weekly by Roads & Grounds personnel.

The outdoor metal storage areas will be inspected (weekly and monthly) to ensure all piping is off the ground on storage racks, large scrap metal is elevated and stored on pallets or contained inside a recycling bin and small scrap metal including shavings and turnings are contained inside a covered recycling bin.

The metal-for-recycle bins will be removed from the facility and emptied at the Metal Recycling Facility (MRF) once they become $\frac{3}{4}$ full.

See also Section 3.2 of this SWPPP.

4.2 Maintenance

Metal-for-recycle bins will be inspected monthly (and when used). If bins or covers need repair or replacement, they will be taken to the Heavy Equipment shop for appropriate maintenance.

Government vehicles and forklifts will be inspected weekly and monthly for leaks and will be taken to the Heavy Equipment shop for maintenance if repairs are needed. Drip pans or absorbent pads/materials will be immediately placed under leaking vehicles until repairs can be made. See also Section 3.4 of this SWPPP.

The heavy duty tarps are inspected monthly (and when used) and will be replaced if found to be torn or defective. An additional supply of the tarps will be kept in stock for replacements.

The Petro-Pipe oil barrier will be removed during winter months to prevent damage from inclement weather, snow removal operations and other vehicle traffic. Manufacturer specifications will be followed for filter replacement.

See also Section 3.3 of this SWPPP.

4.3 Spill Prevention and Response Procedures

See Section 3.4 & 4.2 of this SWPPP.

4.4 Erosion and Sediment Control

The west parking area will be swept monthly (except when not possible during winter months) to reduce sediment accumulation on site. The parking lot area and Outfall #002 will be evaluated during monthly inspections for degradation and sediment accumulation. See also Section 3.5 of this SWPPP.

4.5 Employee Training

Employee training is essential to effective implementation of the SWPPP. The goals for the training program are to ensure that employees are aware of SWPPP requirements, are more capable of preventing spills,

responding safely and effectively to an accident when one occurs, and recognizing situations that could lead to stormwater contamination.

Training relevant to the SWPPP is required for all operational workers at the facility who work in areas where industrial materials or activities are exposed to stormwater; managers and supervisors who are responsible for implementing activities necessary to meet the conditions of this permit (e.g., inspectors, maintenance personnel); and all members of the PPT.

Additionally, employees identified as requiring SWPPP training are:

- Personnel who are responsible for the design, installation, maintenance and/or repair of control measures (including pollution prevention measures);
- Personnel responsible for the storage and handling of chemicals and materials that could become contaminants in stormwater discharges;
- Personnel who are responsible for conducting and documenting monitoring and inspections; and
- Personnel who are responsible for taking and documenting corrective actions.

Training provided and assigned to these personnel cover both the specific control measures used to achieve the effluent limits of Section 3 of the SWPPP; along with monitoring, inspection, planning, reporting, and documentation requirements described in Sections 4 and 5 of this SWPPP. Training will be conducted at least annually.

At a minimum, the training topics that will be covered as part of this SWPPP will include the following:

- An overview of the SWPPP and its contents;
- Spill response procedures, good housekeeping, maintenance requirements, and material management practices;
- Schedules for conducting inspections (routine, quarterly visuals, etc.);
- Site-specific items and structures that will be inspected, site-specific equipment and procedures designed to minimize stormwater pollution and soil erosion; and
- Facility SWPPP updates (i.e. new permit requirements, new structures or procedures implemented or modified due to corrective actions).

Training activities are documented in accordance with the LANL's Training Standards. Training records are maintained at each facility and in Appendix I of this SWPPP. In cases where briefings are formalized enough to be included in employee training plans, the training activity will be recorded in LANL's official training database, U-Train. Informal briefings, such as those included in group safety meetings or for safety roster documentation, are not recorded in U-Train. A list of topics covered and the names of personnel present at the training session will be kept in Appendix I of this SWPPP.

4.6 Stormwater Monitoring

Analytical monitoring comprised of quarterly benchmark and impaired waters monitoring will be performed on stormwater discharges from the site. Monitoring events will be from storm events that result in an actual discharge from the site and that follow the preceding measurable storm event by at least 72 hours (3 days). For runoff from snowmelt, the monitoring will be performed at a time when a measurable discharge from the site occurs.

Monitoring will be conducted according to test procedures approved under 40 CFR Part 136. Runoff samples will be collected by taking a minimum of one grab sample from a discharge, collected within the first 30 minutes of a measurable storm event. If it is not possible to collect the sample within the first 30 minutes of a measurable storm event, the sample will be collected as soon as practicable after the first 30 minutes and documentation will be kept with the SWPPP explaining why it was not possible to take samples within the first 30 minutes.

4.6.1 Monitoring Schedule

For this permit term, monitoring will begin October 1, 2015. Benchmark monitoring will be performed on a quarterly basis at least once in each of the following four 2-month intervals:

- October 1 – November 30
- April 1 – May 31
- June 1 – July 31
- August 1 – September 30

Impaired waters monitoring will be performed on an annual basis with a sample collected in the period between April 1 and November 30.

LANL is located in a high elevation, semi-arid climate where the majority of rainfall occurs during a period between July and September. Freezing conditions that would prevent runoff from occurring for extended periods may also occur during the winter months. For these conditions if benchmark monitoring cannot be performed on the quarterly schedule above, monitoring events will be distributed during seasons when precipitation occurs, or when snowmelt results in a measurable discharge from the site. If adverse weather conditions prevent the collection of samples according to the relevant monitoring schedule, a substitute sample will be collected during the next qualifying storm event or as soon as practical.

Monitoring occurs at automated sampling station #03-0038W (located at Outfall #002) in a grated inlet west of Building 38. Discharge from the facility is east to Los Alamos Canyon (impaired waters), which is a tributary of the Rio Grande located approximately 5 miles east of the facility. Outfall #002 is representative of all stormwater associated with the facility.

Outfall ID	Outfall Location	Activities/Potential Pollutants	Runoff Coefficient	Control Measures
#002	Grated inlet north of Bldg. 37, west of Bldg. 38	Metal residues from metal stock exposed to stormwater, metal shavings, fuel/oil/hydraulic fluid leaks from vehicle or forklift parking	>85%	Scrap metal bins are covered, metal stock is kept off ground on pallets or blocks and covered with thick tarps, pig mats are on hand to place around drain

4.6.2 Substantially Identical Outfalls

Outfall #002 is the sole outfall for the facility.

4.6.3 Monitoring Requirements

Benchmark and impaired waters monitoring will be conducted for this facility as required by the 2015 MSGP. A 2015 MSGP Sampling and Analysis Plan for LANL is provided in Appendix H of this SWPPP.

Table 3 lists the Summary of Monitoring Requirements and LANL’s applicable stormwater monitoring procedures (which also include procedures for gathering storm event data).

Table 3: Summary of Monitoring Requirements

The benchmark and impaired waters monitoring values have been modified to reflect New Mexico facility water quality standards; and are based on values from the *Standards for Interstate and Intrastate Surface Waters (as approved on June 5, 2013), 20.6.4.900 NMAC* as set forth in section 9.6.2.1 of the 2015 MSGP.

Monitoring Type	Location	Parameters		Numeric Limitations	Schedule
Benchmark Subsector AA1. Fabricated Metal Products, except Coating (SIC 3411-3499; 3911-3915)	#03-0038W Outfall #002 Sandia Canyon	Total Aluminum*	0.681 mg/L	None *Hardness Dependent 57 (60) mg/L	Quarterly
		Total Iron	1.0 mg/L		
		Total Zinc1*	0.076 mg/L		
		Nitrate plus Nitrite Nitrogen	0.68 mg/L		
Impaired Waters	#03-0038W Outfall #002 Sandia Canyon	Aluminum	0.681 mg/L	None	Annual
		Gross Alpha, adjusted	15 pCi/L		
		Copper	0.006 mg/L		
		Thallium, dissolved	0.47 ug/L		
		PCB in Water Column	0.00064 ug/L		

Procedures (see Appendix L for documents):

- ENV-CP-QP-045, *Installing, Setting up, and Operating ISCO Samplers for the MSGP:*
<http://int.lanl.gov/training/env-courses/55962/env-cp-qp-045.pdf>
- ENV-CP-QP-048, *Processing MSGP Stormwater Samples:*
<http://int.lanl.gov/training/env-courses/56595/env-cp-qp-048.pdf>
- ENV-RCRA-QP-047, *Inspecting Stormwater Runoff Samplers and Retrieving Samples for the MSGP:*
<http://int.lanl.gov/training/env-courses/56594/env-rcra-qp-047.pdf>
- ENV-CP-QAPP-MSGP, *Quality Assurance Project Plan for the Stormwater MSGP:*
<http://int.lanl.gov/training/env-courses/43337/env-cp-qapp-msgp.pdf>

*Hardness data based on average monitoring results for Sandia Canyon (2009-2015). Data provided in Appendix H.

4.6.4 Monitoring Results

If the average of the 4 monitoring values for any parameter exceeds the benchmark, or if prior to completion of 4 quarterly samples, an exceedance of the 4 quarter average is mathematically certain, the Pollution Prevention Team and ENV-CP personnel will:

- Review the selection, design, installation, and implementation of control measures to determine if modifications are necessary to meet the effluent limits,
- Implement the necessary modifications, and
- Continue quarterly monitoring until 4 additional quarters of monitoring have been completed for which the average does not exceed the benchmark.

If the average of the 4 monitoring values for any parameter does not exceed the benchmark, monitoring for that particular parameter will no longer be performed.

4.6.5 Recordkeeping

For each monitoring event, except snowmelt monitoring, the following information will be recorded and maintained through field data sheets, LANL database systems, and Discharge Monitoring Records:

- The date, exact place, and time of sampling or measurements;
- The date and duration (in hours) of the rainfall event
- Rainfall total (in inches) for that rainfall event
- Time (in days) since the previous measurable storm event
- The individual(s) who performed the sampling or measurements;
- The date(s) analyses were performed
- The individual(s) who performed the analyses;
- The analytical techniques or methods used; and
- The results of such analyses.

For snowmelt monitoring, all information except rainfall event durations, totals, and time since previous event will be included. Additionally, all records of monitoring information, including all calibration and maintenance records will be maintained for a minimum period of at least three years from the date the permit expires.

SECTION 5: INSPECTIONS AND CORRECTIVE ACTIONS

5.1 Routine Facility Inspection Procedures

Routine inspections at this facility will be conducted and documented monthly and per ENV-RCRA-QP-022, MSGP Stormwater Corrective Actions: <http://int.lanl.gov/training/env-courses/54892/env-rcra-qp-022.pdf> (document provided in Appendix L).

At least once each calendar year, the routine inspection will be conducted during a period when a stormwater discharge is occurring. The inspection will be performed by a qualified member of the Stormwater PPT (typically the DEP or ENV-CP Technical Lead). The 2015 MSGP consolidates the different and separate documentation requirements in the Comprehensive Site Inspection Procedures and Routine Facility Inspection Procedures from the 2008 MSGP. ENV-CP will perform at least one routine inspection per year in order to evaluate corrective action status for the Annual Report requirements.

Routine inspections will evaluate the following areas, at a minimum:

- Areas where industrial materials or activities are exposed to stormwater;
- Areas identified in the SWPPP and those that are potential pollutant sources;
- Areas where spills and leaks have occurred in the last three years;
- Discharge points(outfalls/SIOs); and
- Control measures used to comply with the effluent limits contained in this permit.

Specific areas of the facility to be inspected include (see descriptions in Section 3.7):

- Raw Steel Handling Storage Areas
- Metal Fabricating Areas
- Storage Areas for Raw Metal
- Metal Working Fluid Storage Areas
- Cleaners and Rinse Water
- Lubricating Oil and Hydraulic Fluid Operations
- Chemical Storage Areas

During routine inspections the following must be examined and looked out for:

- Industrial materials, residue or trash that may have or could come into contact with stormwater;
- Leaks or spills from industrial equipment, drums, tanks and other containers;
- Offsite tracking of industrial waste or materials, or sediment where vehicles enter or exit the site;
- Tracking or blowing of raw, final or waste materials from areas of no exposure to exposed areas; and

- Control measures needing maintenance, repairs or replacement including: metal/pipe storage racks, pallets and tarps used for metal storage, covers on the metal-for-recycle bins, all grated storm drains, and the asphalt swale and rock lined drainage east of building 3-38.

The Stormwater PPT member performing the inspection will document the inspection and will note potential storm water pollution problems that were encountered on the routine facility inspection form. Any required corrective actions identified during the inspection will be addressed in accordance with Section 5.4

Corrective Actions Process of this plan. Facility personnel or the Deployed Environmental Professional may also perform daily, weekly, or other periodic facility surveys in between monthly routine inspections to further ensure compliance with the SWPPP. The routine inspection form can be found in Appendix F of this SWPPP and meets the requirements listed in the 2015 MSGP (Section 3.1.2.).

5.2 Quarterly Visual Inspection Procedures

Visual inspections are conducted in accordance with ENV-RCRA-QP-064, MSGP Stormwater Visual Inspections: <http://int.lanl.gov/training/env-courses/50493/env-rcra-qp-064.pdf> (document provided in Appendix L).

Once each quarter (April 1-May 31, June 1-July 31, August 1-September 30, October 1-November 30) a sample and visual assessment must be collected and performed at each outfall. The visual assessment will be conducted by a qualified member of the Stormwater PPT (Deployed Environmental Professional or ENV-CP Technical Lead). The visual assessment must be:

- Of a sample in a clean, clear colorless glass or plastic container and examined in a well-lit area;
- On samples collected within the first 30 minutes of an actual discharge from a storm event or as soon as practical thereafter. Or document why it was not possible to collect the sample within the first 30 minutes (i.e. adverse conditions, not enough flow, etc.)
- Conducted at least 72 hours since the last storm event; or document that the 72 hour period is representative of your local storm events during the sampling period.

The visual assessment will inspect for the following water quality characteristics: color, odor, clarity, floating solids, settled solids, suspended solids foam, oil sheen, and other obvious indicators of stormwater pollution.

Exceptions to visual assessments:

- Document rationale if a visual assessment is unable to be collected in a quarter (no precipitation event or adverse conditions, etc.);
- Perform an additional assessment during the next qualifying storm event if unable to perform in a particular quarter; and
- Perform one quarterly assessment during snow melt discharge (taken during a measurable discharge from the site).

For facilities with significantly identical outfalls, quarterly visual assessments may be performed at only one of the outfalls; provided that you perform visual inspections on a rotating basis at each outfall.

The Stormwater PPT member performing the visual assessment will document potential stormwater pollution problems that were observed during the assessment on the Quarterly Visual Assessment form (Appendix F). Any required corrective actions identified during the assessment will be addressed in accordance with Section 5.4 *Corrective Actions Process* of this plan.

5.3 Corrective Actions Process

When any of the following conditions occur or are detected during an inspection, monitoring or any other means, this SWPPP (e.g., sources of pollution; spill and leak procedures; non-stormwater discharges; the

selection, design, installation and implementation of control measures) will be reviewed and revised (as appropriate) so that the effluent limits of the 2015 MSGP permit are met and pollutant discharges are minimized:

- An unauthorized release or discharge (e.g., spill, leak, or discharge of non-storm water not authorized by this or another NPDES permit to a water of the U.S.) occurs at the facility;
- A discharge violates a numeric effluent limit;
- Control measures are not stringent enough for the discharge to meet applicable water quality standards or non-numeric effluent limits;
- An inspection identifies that a required control measure was never installed, was installed incorrectly or is not being properly operated or maintained; and
- Whenever a visual assessment shows evidence of stormwater pollution.

If the event triggering corrective action is associated with an outfall that is identified as an SIO, the review of the need for action must encompass all related SIOs.

Immediate Actions: If a corrective action is required, immediate steps must be reasonably taken to minimize or prevent discharges from occurring (i.e. spill clean-up, scheduling repairs) until a permanent solution (if needed) can be implemented. Immediate action means all reasonable steps must be taken the same work day or no later than the following work day (when it is too late in the day to take corrective action).

Subsequent Actions: If further corrective actions are required (e.g. installing or making operational a new or modified control, completing repairs, ordering BMPs) they must be completed by the next storm event, if possible or within 14 calendar days (from initial discovery). If it is infeasible to complete corrective actions within 14 days, documentation of why it is infeasible must be provided in the SWPPP. This documentation must also include a timeframe and schedule for completion of the work, which must be completed no later than 45 days (from initial discovery). If time needed to make corrective actions will exceed 45 days, EPA must be notified and provided a justification of why actions will exceed the timeframe; and a minimal amount of additional time to complete the work may be approved.

Upon discovery, required corrective actions will be documented by the DEP (or ENV-CP) and entered into the Corrective Action Database (CAR). The action will be kept open in the database until the issue has been resolved. The DEP and other PPT members will receive reminder e-mail notifications of the pending corrective action until it is closed-out. Only repeat CARs are tracked in the Performance Feedback Issues Tracking System (PFITS). Documentation of Maintenance and Repairs of Control Measures (BMPs) will be kept in Appendix J1 of this SWPPP. Where corrective actions result in changes to procedures or controls documented in this SWPPP, modifications to the SWPPP will be made accordingly within 14 days of completing the corrective action(s).

5.4 Conditions Requiring Review to Determine if Modifications Are Necessary

If any of the following conditions occur, a review of the selection, design, installation, and implementation of control measures will be performed to determine if modifications are necessary to meet the effluent limits in this permit:

- Construction or a change in design, operation, or maintenance at the facility significantly changes the nature of pollutants discharged in stormwater from the facility, or significantly increases the quantity of pollutants discharged; or
- The average of 4 quarterly sampling results exceeds an applicable benchmark. If less than 4 benchmark samples have been taken, but the results are such that an exceedance of the 4 quarter average is mathematically certain (i.e., if the sum of quarterly sample results to date is more than 4 times the benchmark level) this is considered a benchmark exceedance, triggering this review.

If a review identifies any necessary modifications, they will be performed following the corrective action process identified in Section 5.4 above.

SECTION 6: DOCUMENTATION TO SUPPORT ELIGIBILITY CONSIDERATIONS UNDER OTHER FEDERAL LAWS

6.1 Documentation Regarding Endangered Species

The Los Alamos National Laboratory (LANL) Threatened and Endangered Species Habitat Management Plan (HMP) was prepared to provide for the protection of federally listed threatened and endangered species and their habitats at LANL. The HMP was designed to be a comprehensive landscape-scale management plan that balances the current operations and future development needs of LANL with the habitat requirements of threatened and endangered species. It also facilitates DOE compliance with the Endangered Species Act and related federal regulations. The HMP received concurrence from the U.S. Fish and Wildlife Service (USFWS) and was first implemented in 1999. All changes to the HMP, such as adding new species or changing requirements, are assessed in a new consultation with the USFWS before being implemented. The HMP provides guidance by species for different types of activities allowed without further review by the USFWS.

Currently, the only federally-listed species that have habitat or occur at LANL are the Southwestern Willow Flycatcher (*Empidonax traillii extimus*), Jemez Mountains Salamander (*Plethodon neomexicanus*), and Mexican Spotted Owl (*Strix occidentalis lucida*). Suitable habitats for these species, along with a protective buffer area surrounding the habitats, have been designated as Areas of Environmental Interests (AEIs). An AEI consists of a core area that contains important breeding or wintering habitat for a specific species and a buffer area around the core area. The buffer protects the core area from disturbances that would degrade the value of the core area to the species.

The HMP includes eco-risk analyses which account for any industrial facility's stormwater discharges, allowable non-stormwater discharges, and stormwater discharge-related activities. In addition, the Site-wide Environmental Impact Statement (SWEIS) biological assessment (BA) covered the continuation of Laboratory operations and included outfalls.

As determined by earlier evaluations, stormwater discharges, allowable non-stormwater discharges, and stormwater discharge-related activities from LANL MSGP locations are not likely to adversely affect any species that is federally-listed as endangered or threatened under Criterion D Section iii, the ESA, and will not result in the adverse modification or destruction of habitat that is federally-designated as "critical habitat" under the ESA. New activities are evaluated to determine if they will have an impact to any species. If an activity can be completed within the guidelines of the HMP it can go forward as scheduled; however, if the activity can not comply with the guidelines, the HMP requires that a project-specific BA be prepared for the action and go through the consultation process with the USFWS.

The LANL HMP and other applicable critical habitat documentation can be found in Appendix K of this SWPPP.

6.2 Documentation Regarding Historic Properties

In August, 2015 and December 2008, the Cultural Resources Team (using GPS spatial data as well as conducting visual inspections), reviewed the Laboratory industrial sites (see list below) and their associated outfalls and monitoring stations subject to the 2015 Multi-Sector General Permit (Permit #NMR050000) for effects on historic properties. All of these sites were found to be undertakings of no effect and in compliance with Section 106 of the National Historic Preservation Act (i.e., Criterion B).

- TA-3-22 Power and Steam Plant
- TA-3-38 Metals Fabrication Shop
- TA-3-38 Wood Shop
- TA-3-39 and 102 Metal Shop
- TA-3-66 Sigma Complex

- TA-60 Asphalt Batch Plant
- TA-60-1 Heavy Equipment Yard
- TA-60 Material Recycle Facility
- TA-60 Roads and Grounds
- TA-60-2 Warehouse
- TA-54 Area L
- TA-54 Area G
- TA-54 Maintenance Facility West
- TA-54 RANT

6.3 Documentation Regarding NEPA Review

The Final Site-Wide Environmental Impact Statement for the Operation of Los Alamos National Laboratory (DOE/EIS-0380) was issued in May 2008, and a Record of Decision in September 2008. Stormwater issues and associated pollution prevention requirements and activities at LANL are analyzed in Chapters 4 and 5 of the 2008 Site-Wide EIS. These activities are integrated into environmental reviews on a project-specific level through LANL's Integrated Review Tool (IRT), which incorporates both the Excavation Permit (EX-ID) and Permit Requirements Identification (PR-ID) process. Stormwater issues are identified and pollution prevention activities are implemented during the design and construction phases of all LANL projects, and as part of facility operations, including routine maintenance. LANL staff monitors stormwater pollution prevention compliance at the MSGP sites in accordance with Section 4.6 *Stormwater Monitoring* of this plan. Corrective actions are taken as necessary as described in Section 5.3 *Corrective Actions Process* of this plan.

SECTION 7: SWPPP CERTIFICATION

STORMWATER POLLUTION PREVENTION PLAN
TA-3-38 Metals Fabrication Shop
Los Alamos National Laboratory

CERTIFICATION STATEMENT

"I certify under penalty of law that this document and all attachments were prepared under my direction or supervision in accordance with a system designed to assure that qualified personnel properly gathered and evaluated the information submitted. Based on my inquiry of the person or persons who manage the system, or those persons directly responsible for gathering the information, the information submitted is, to the best of my knowledge and belief, true, accurate, and complete. I am aware that there are significant penalties for submitting false information, including the possibility of fine and imprisonment for knowing violations."

Signature: _____



Date: _____

1-28-16

John F. Merhege

Division Leader

LOG-DIV: Logistics Division

SECTION 8: SWPPP MODIFICATIONS

The SWPPP will be modified by the PPT and reviewed by the ENV-CP Technical Advisor(s) whenever necessary to address any of the triggering conditions for corrective actions listed in Section 5.4 of this SWPPP to ensure that they do not reoccur; or to reflect changes implemented when a review following the triggering conditions listed in Section 5.4 of this SWPPP indicates that changes to control measures are necessary to meet the effluent limits described in this SWPPP. Changes to this SWPPP document must be made in accordance with the corrective action deadlines defined in Section 5.4 and must be signed and dated in accordance with the signatory requirements listed in Appendix B Subsection 11 (Signatory Requirements) of the 2015 MSGP. A record of amendments to the SWPPP will be tracked in the amendment log located in Appendix E of this SWPPP.

APPENDIX A

Stormwater Pollution Prevention Team Members

Stormwater Pollution Prevention Team Members

Pollution Prevention Team Leader

Name: Thomas P. Chavez

Title: Metals Fabrication Shop Superintendent

Office: 505-606-1568

Cell: 505-699-5994

Email: tpc@lanl.gov

Duties: Responsible for ensuring that the requirements of this SWPPP (including corrective actions) are met; overseeing the assigned duties of other PPT members; and communication of information to the group leader and LANL support organizations.

Maintenance and Oversight Officer

Name: David M. Olivas

Title: Facility Coordinator

Office: 505-667-6503

Cell: 505-699-7224

Email: olivas@lanl.gov

Duties: Responsible for review of proposed work at the TA-3-38 MFS to ensure compliance with this SWPPP; initiate and follow through with corrective actions to maintain BMPs.

ENV-CP MSGP Compliance Project Lead

Name: Holly Wheeler

Title: MSGP SWPPP Technical Lead

Office: 505- 667-1312

Email: hbenson@lanl.gov

Duties: Provide technical guidance on SWPPP contents, adequacy, and implementation; aides in performing and documenting the routine and quarterly visual inspections; provide guidance on BMPs; and assists with revising this SWPPP as needed. Provide annual report data, stormwater monitoring data (DMRs) and other applicable NPDES permit information to EPA.

Environmental Technical Advisor(s)/Inspector(s)

Name: Jillian E. Burgin

Title: Deployed Environmental Professional, CISEC / MSGP SWPPP Inspector

Office: 505-665-1893

Email: jeburgin@lanl.gov

Duties: Provide technical guidance concerning SWPPP contents, adequacy, and implementation; assists ENV-CP in performing and documenting the routine inspections and quarterly visual assessments; provides guidance on corrective actions, BMPs, and assists with revising this SWPPP as needed.

Name: Leonard F. Sandoval

Title: Deployed Environmental Professional, CISEC / MSGP SWPPP Inspector

Office: 505-667-3557

Cell: 505-699-1235

Email: lesandov@lanl.gov

Duties: Provide technical guidance concerning SWPPP contents, adequacy, and implementation; assists ENV-CP in performing and documenting the routine inspections and quarterly visual assessments; provides guidance on corrective actions, BMPs, and assists with revising this SWPPP as needed.

APPENDIX A1

**SWPPT Meeting Notes and
Other Documentation Relative to the SWPPP**

APPENDIX B

Site Maps

Figure B-1, Regional Location Map

Figure B-2, General Location Map (Includes nearby surface waters and receiving waters)

Figure B-3, Facility Site Map

Figure B-4, Endangered Species Habitat Within LANL

Figure B-1, Regional Location Map

0 0.5 1 1.5 2 Miles

SANTA CLARA INDIAN RESERVATION

- Major road
- Minor road
- Los Alamos National Laboratory
- Technical Area boundary
- Ownership boundary
- County boundary

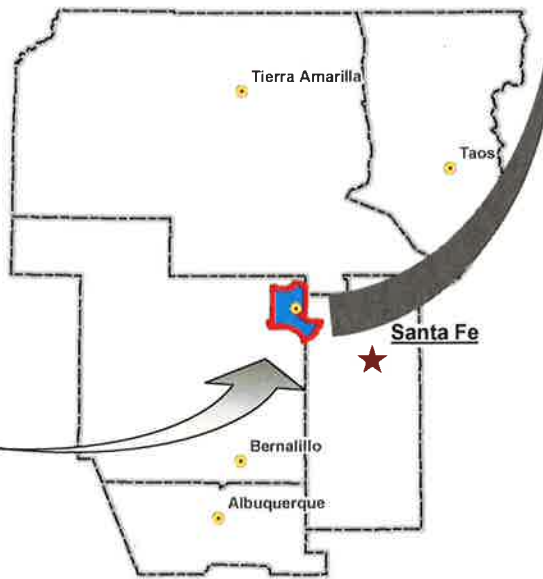
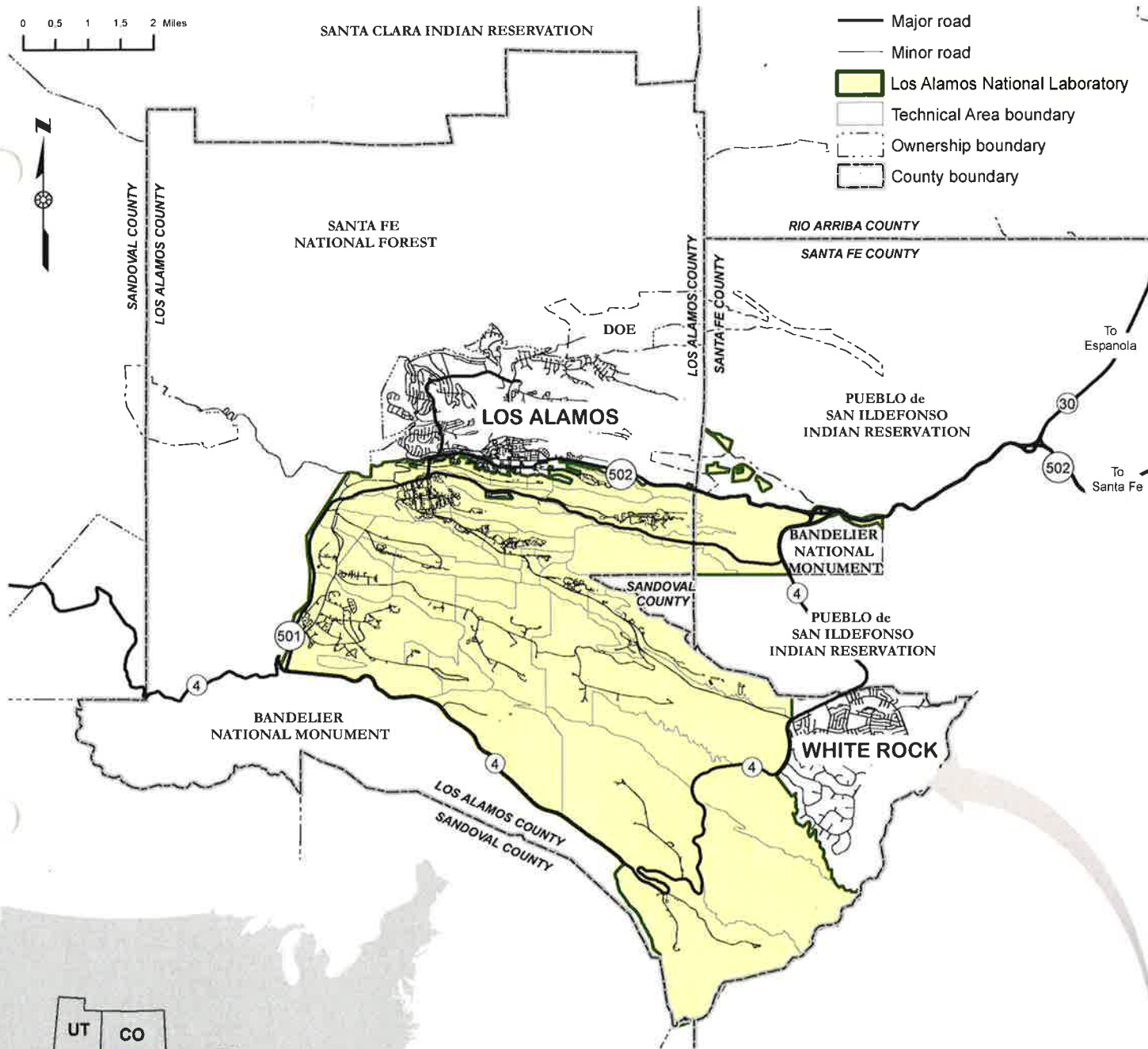

**Figure B-2, General Location Map
Location of Nearby Surface Waters and Receiving Waters**

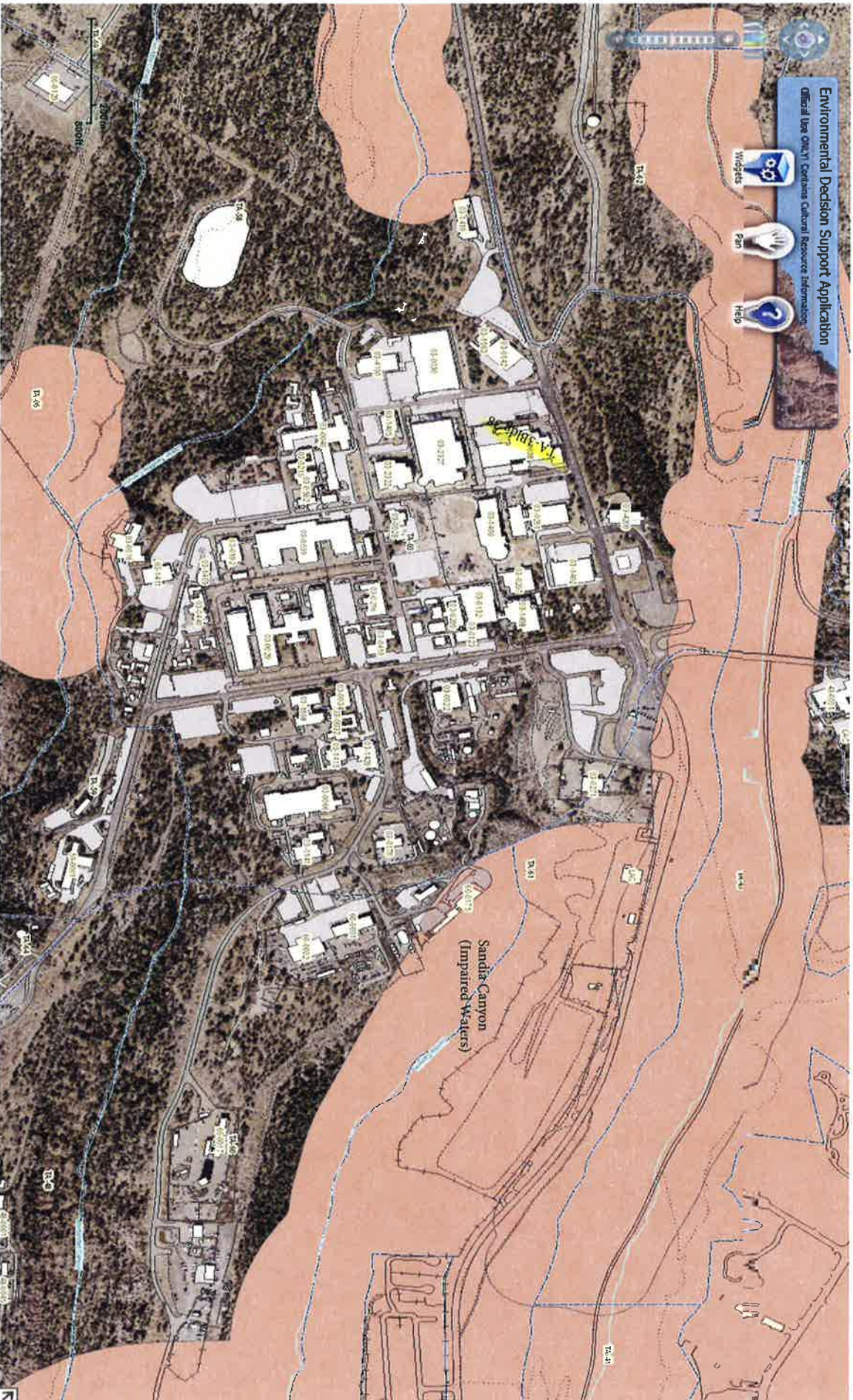

Peach Layer = Critical Habitat

Figure B-3, Facility Site Map

TO SANDIA CANYON impaired water (no TMDL)

TA-3 SM38 METALS FABRICATION SHOP AREAS OPERATIONAL SWPPP

1.83 Acres 100% impervious surface

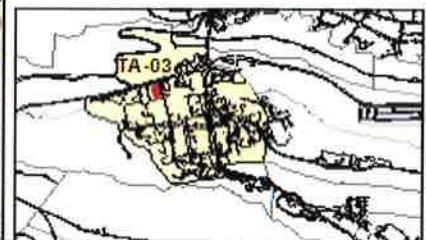

LEGEND

- 07 SPILL (WITH YEAR)
- SUMP
- USED OIL CAGE
- SAA# 865
- ▲ RUSTLICK SC 3000
- ▲ OUT FALLS
- BOUNDARY OF INDUSTRIAL ACTIVITY
- DIRECTION OF FLOW
- INDUSTRIAL FENCE
- SECURITY FENCE
- CONTOURS 10 FT
- ASPHALT BERM
- LOADING & UNLOADING AREA
- OIL RECYCLE BINS
- DRAIN INLET
- SPILL KIT
- PRS/SWMU
- STRUCTURES
- ASPHALT SWALE
- CRITICAL HABITAT AREAS (NONE)
- OIL STORAGE AREA
- COVERED METAL STORAGE RACKS
- COVERED METAL FOR RECYCLE BIN

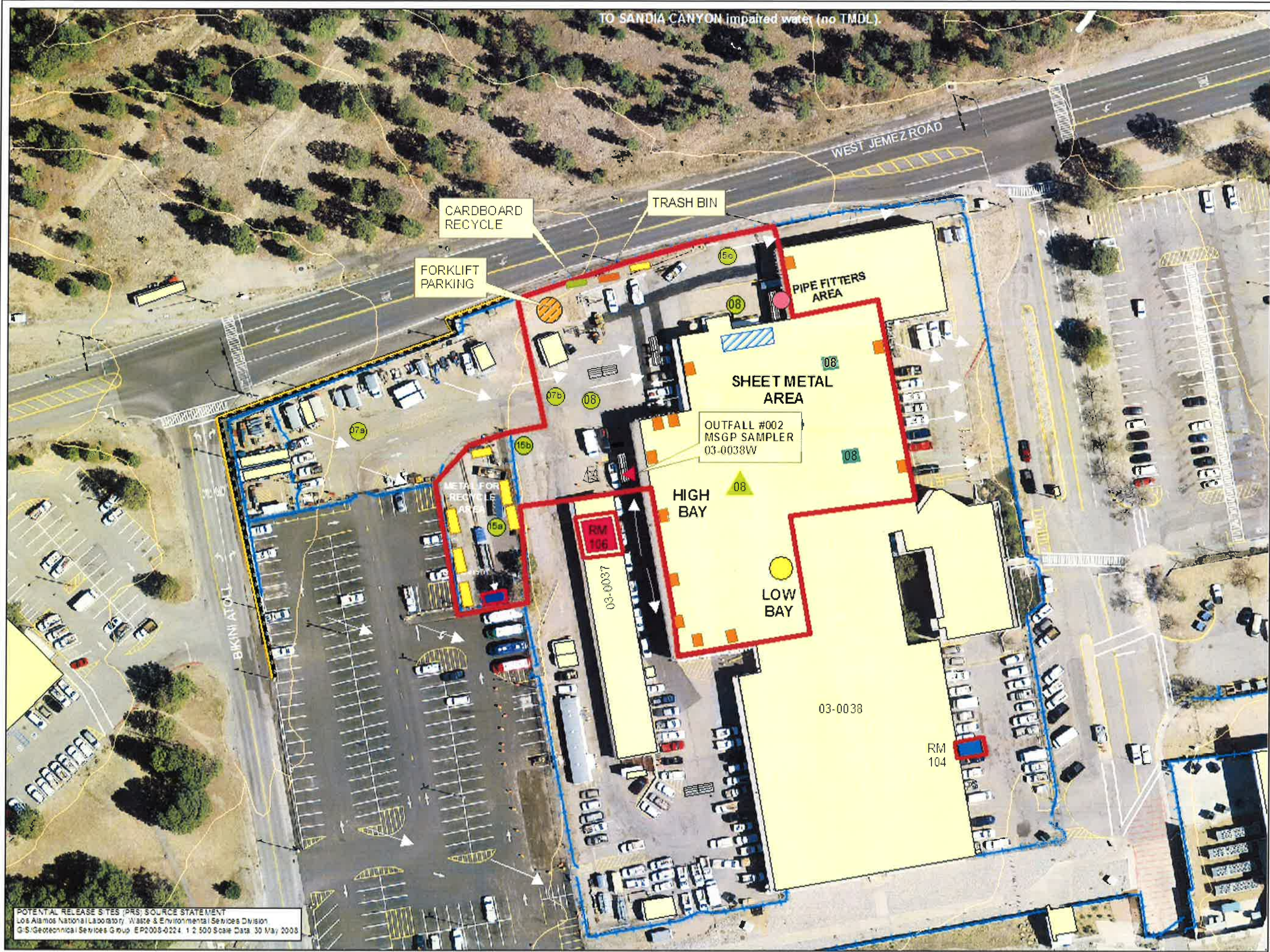

POTENTIAL RELEASE SITES (PRS) SOURCE STATEMENT
 Los Alamos National Laboratory Waste & Environmental Services Division
 G-S:Geotechnical Services Group EP2008-0224 1:2,500 Scale Data 30 May 2008

Figure B-4, Endangered Species Habitat Within LANL

Endangered Species Habitat Within Los Alamos National Laboratory

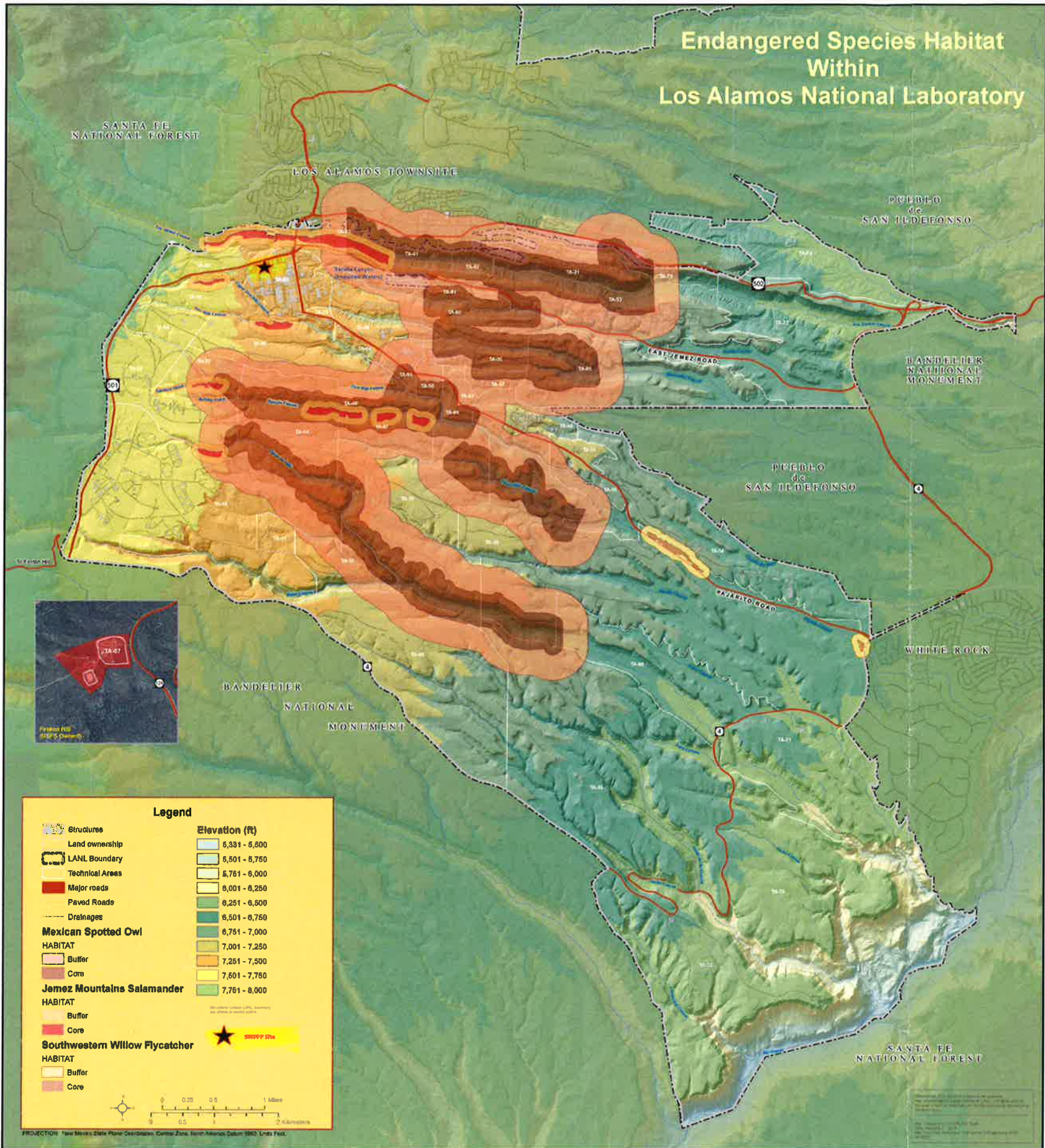

Legend

Structures	Elevation (ft)
Land ownership	6,331 - 6,800
LANL Boundary	6,501 - 6,750
Technical Areas	6,761 - 6,000
Major roads	8,001 - 6,250
Paved Roads	8,251 - 6,500
Drainages	6,501 - 6,750
Mexican Spotted Owl	6,751 - 7,000
HABITAT	7,001 - 7,250
Buffer	7,251 - 7,500
Core	7,501 - 7,750
Jemez Mountains Salamander	7,761 - 8,000
HABITAT	
Buffer	
Core	
Southwestern Willow Flycatcher	
HABITAT	
Buffer	
Core	

200999 Site

PROJECTION: True Meridian, Ellipsoid: Clarke, Central Zone, North American Datum 1983, Units: Feet.

APPENDIX C

NOI and LANS Delegation of Authority Letter



Environmental Protection Division
Environmental Compliance Programs (ENV-CP)
PO Box 1663, K490
Los Alamos, New Mexico 87545
(505) 667-0666

Date: OCT 29 2015
Symbol: ENV-DO-15-0309
LA-UR: 15-28383
Locates Action No.: N/A

Mr. Brent Larsen
Water Quality Protection Division (6WQ)
U.S. Environmental Protection Agency, Region 6
1445 Ross Avenue, Suite 1200
Dallas, TX 75202-2733

Dear Mr. Larsen:

Subject: National Pollutant Discharge Elimination System (NPDES) Permit Tracking No. NMR053195, Multi-Sector General Permit (MSGP) Notice of Intent (NOI) Reporting Pursuant to Part B.12.H.

In submitting a NOI for coverage under the new NPDES Multi-Sector General Permit, Los Alamos National Security (LANS) experienced significant problems with EPA's NeT NPDES eReporting Tool which resulted in certification of the NOI on September 3 and initial submission of a NOI with incomplete outfall attribute data and incorrect information. During this time LANS staff contacted EPA's NOI Processing Center for support and was given the recommendation to contact Region 6 personnel for further guidance. Per this direction, on September 1, 2015, Terrill Lemke left you a voicemail summarizing the issues and potential impacts of the difficulties experienced with the new electronic reporting system. For additional clarification, the following is a summary of the timeline of events associated with the NOI submission.

- Monday, August 31, 2015
 - Initiated NOI submission using the NeT NPDES eReporting Tool.

- As data was entered into each data field on the NOI form, the Tool was very slow in processing the data and allowing entry into the next field. This created a significant waiting time.
- Upon reaching the fields on the NOI form where outfall attribute data was entered the Tool began to randomly crash, repeatedly deleting all unsaved data.
- Tuesday, September 1, 2015
 - Tool continued to be very slow and randomly crash, repeatedly deleting all unsaved data.
 - For each outfall, when listing the constituents associated with impaired waters, the Tool's auto population feature initially displayed incorrect data which required additional editing and then eventually stopped functioning and caused the Tool to crash.
 - Much of the outfall attribute data had to be reentered multiple times before it was possible to successfully save it to the system.
 - After each save or Tool crash the eReporting Tool would close the NOI form. The time required for the Tool to repeatedly reopen the form made data entry very time consuming.
 - LANS staff contacted the EPA NOI Processing Center on the afternoon of Sept 1 for technical support:
 - NOI Processing Center staff stated that they had been "flooded" with calls over the past week on Tool problems.
 - LANS staff expressed their concern about the length of time being required to enter data and the potential inability to complete the NOI form by the Sept 2 deadline. No solution was available.
 - LANS staff explained the difficulty with entering outfall information for 73 outfalls and NOI Processing Center staff stated that they had received numerous calls on problems with entering outfall data and that some permittees couldn't even enter 20 outfalls.
 - NOI Processing Center staff recommended contacting Regional personnel to notify them of the situation and to seek additional guidance.
 - The eReporting Tool went down at approximately 3:30 pm MDT and remained down until after 9 pm MDT. This eliminated the opportunity to input data during normal business hours.
- Wednesday, September 2, 2015
 - Continued decrease in the performance of the eReporting Tool.
 - Increase in the time for the Tool to process information after entry of each item of data.
 - Increased frequency in the Tool crashing.
 - For each outfall, when listing the constituents associated with impaired waters, the form had to be saved after entry of each individual constituent. Entry of more than one constituent without saving would cause the Tool to crash.

- With the decreased performance of the eReporting Tool LANS staff contacted the EPA NOI Processing Center for direction and Processing Center staff stated the following:
 - They were aware of the problems with the Tool but could provide no solutions or technical direction.
 - They had been reporting daily to EPA on the problems and EPA was definitely aware of the issues.
 - When asked about taking the Tool down at 3:30 MDT on Sept. 1, staff stated that they thought the programmers may have taken the system down to assess the problems.
 - Stated again that they had received many calls about technical issues with the Tool.
 - The more data that was entered the slower the Tool would get.
 - When asked again about the possibility that LANS may not be able to get all information into the NOI, staff stated that LANS would be able to access the submitted NOI to modify/add data after the 30 day waiting period.
- eReporting Tool went down again at 3:30 pm MDT and did not come back up until after 10 pm MDT, again eliminating the opportunity to input data during normal business hours.
- The LANS NOI with all information except some remaining outfall attribute data was submitted by the Preparer at 10:50 pm MDT.
 - The LANS NOI certification signatory was prepared to certify the NOI at this time but didn't get notification that the NOI was ready for certification until 9:37 am MDT on Sept. 3, almost 11 hours later.
 - The NOI was certified on Sept 3, 2015.

Additionally, the NeT NPDES eReporting Tool did not provide dissolved Thallium as a constituent option, but only allowed the selection of total Thallium as an impaired water pollutant under a "Cause Group" when "Metals (other than Mercury)" was selected from the drop down menu. This resulted in LANS having to enter total Thallium as an impaired water pollutant in error for the following outfalls: 002, 005, 006, 007, 008, 009, 010, 011, 012, 016, 017, 018, 019, and 020. LANS appreciates any assistance you may have relative to the total Thallium vs. dissolved Thallium issue. During a subsequent quality assurance evaluation, LANS staff also determined that total Copper was erroneously entered as an impaired water pollutant for outfall 051 and needs to be deleted from the NOI.

LANS is committed to maintaining compliance with the MSGP requirements. Per Section B.12.H of the MSGP, the LANS NOI will be modified to include the remaining outfall attribute data that could not be included on the initial submission and to delete Copper as an impaired water pollutant for outfall 051. LANS coverage under the 2015 MSGP became effective on October 3, 2015, and with the NOI now accessible, actions to update the NOI have been initiated.

Mr. Brent Larsen
ENV-DO-15-0309

- 4 -

Any additional direction or guidance you may have would be appreciated. Please contact Terrill W. Lemke at (505) 665-2397 of the Environmental Compliance Programs (ENV-CP) if you have any questions.

Sincerely,



Anthony R. Grieggs
Group Leader
Environmental Compliance Programs (ENV-CP)
Los Alamos National Security, LLC

ARG:MTS:TWL:HLW/lm

Cy: Nasim Jahan, USEPA/Region 6, Dallas, TX, (E-File)
Bruce Yurdin, NMED/SWQB, Santa Fe, NM, (E-File)
Gene E. Turner, LASO-NS-LP, (E-File)
Jordan Arnsward, LASO-NS-PI, (E-File)
Kirsten Laskey, EM-LA, (E-File)
Craig Leasure, PADOPS, (E-File)
Amy E. De Palma, PADOPS, (E-File)
Michael T. Brandt, ADESH, (E-File)
Raeanna Sharp-Geiger, ADESH, (E-File)
Alison M. Dorries, ENV-DO, (E-File)
Michael T. Saladen, ENV-CP, (E-File)
Terrill W. Lemke, ENV-CP, (E-File)
Holly L. Wheeler, ENV-CP, (E-File)
Timothy A. Dolan, LC-ESH, (E-File)
lasomailbox@nnsa.doe.gov, (E-File)
locatsteam@lanl.gov, (E-File)
env-correspondence@lanl.gov

From: [Lemke, Terrill W](#)
To: [Wheeler, Holly Lynn](#); [Grieggs, Tony](#)
Subject: FW: EPA Multi-Sector General Permit (MSGP) Authorization is Active – Los Alamos National Laboratory, NPDES ID: NMR053195, NeT Submission ID: MSGP-3095
Date: Monday, October 05, 2015 8:22:15 AM
Attachments: [AcceptedNewNOIReceipt.pdf](#)

Terrill Lemke, PE, CPESC, CISEC
Environmental Compliance Programs
Los Alamos National Laboratory
Los Alamos, NM
Office: 505-665-2397
Cell: 505-699-0725

From: NeT@epa.gov [mailto:NeT@epa.gov]
Sent: Saturday, October 03, 2015 5:48 PM
To: Dorries, Alison Marie
Cc: Lemke, Terrill W; lee.won@epa.gov; lescure.nasrin@epa.gov; emily@avanticorporation.com; farris.erika@epa.gov; Christiane@avanticorporation.com; bius.catherine@epa.gov
Subject: EPA Multi-Sector General Permit (MSGP) Authorization is Active – Los Alamos National Laboratory, NPDES ID: NMR053195, NeT Submission ID: MSGP-3095

2015-10-03

Your Notice of Intent (NOI) requesting coverage for Los Alamos National Laboratory, PO Box 1663 MS K490 Los Alamos NM 87545 under EPA's Multi-Sector General Permit (MSGP) has been accepted and authorization to discharge under the MSGP became effective at the conclusion of your 30-day waiting period, on 2015-10-03.

For tracking purposes, the following NPDES ID has been assigned to your NOI: NMR053195. Attached to this email, you will find a copy of your completed NOI form. To access your NOI in NeT, please visit: https://cdx.epa.gov/epa_home.asp.

As you know, the MSGP requires you to have developed a Stormwater Pollution Prevention Plan (SWPPP) prior to submitting your NOI. The MSGP also includes specific requirements for implementing control measures (e.g., minimize exposure, good housekeeping, maintenance, spill prevention and response), conducting self-inspections and visual assessments of your discharges, taking corrective actions, and conducting staff training. You must comply with any specific requirements applicable to your industrial sector(s) in Part 8 and any state/tribal-specific requirements in Part 9 (see <http://water.epa.gov/polwaste/npdes/stormwater/EPA-Multi-Sector-General-Permit-MSGP.cfm>). You are also required to submit an Annual Report in accordance with Part 7.5 of the MSGP that will contain the results from your past year's routine facility inspections, quarterly visual assessments, and corrective actions. Annual Reports must be submitted to EPA through NeT.

The MSGP includes five types of required analytical monitoring, one or more of which may apply to your discharge:

- Quarterly benchmark monitoring (see Part 6.2.1 and Part 8);
- Annual effluent limitations guidelines monitoring (see Part 6.2.2 and Part 8);
- State- or tribal-specific monitoring (see Part 6.2.3 and Part 9);
- Impaired waters monitoring (see Part 6.2.4); and
- Other monitoring as required by EPA (see Part 6.2.5).

Monitoring requirements in the MSGP (i.e., parameters required to be monitored and sample frequency) will be prepopulated on your electronic Discharge Monitoring Report (DMR) in EPA's NetDMR system, which is accessed at <http://www.epa.gov/netdmr/>. Where you have determined that no monitoring requirements apply to your discharge, there is no need to access the NetDMR system. In order to obtain access to this system, you must complete the electronic signature process. Please refer to the following guidance for information about submitting monitoring reports through NetDMR:

<http://water.epa.gov/polwaste/npdes/stormwater/Stormwater-eNOI-System-for-EPAs-MultiSector-General-Permit.cfm>.

Please note that this email does not represent a determination by EPA regarding the validity of the information you provided in your NOI. Your eligibility for coverage under this permit is based on the validity of the certification you provided. Your electronic signature on the NOI form certifies that you have read, understood, and are implementing all of the applicable requirements. An important aspect of this certification requires that you have correctly determined whether you are eligible for coverage under this permit.

The 2014 MSGP and additional guidance are available at:

<http://water.epa.gov/polwaste/npdes/stormwater/EPA-Multi-Sector-General-Permit-MSGP.cfm>. Please contact your EPA Regional permitting authority at lee.won@epa.gov; lescure.nasrin@epa.gov; emily@avanticorporation.com; farris.erika@epa.gov; Christiane@avanticorporation.com; bius.catherine@epa.gov for more information.

This is an automated response; please do not reply to this email.



2015 NPDES Multi-Sector General Permit For Stormwater Discharges Associated With Industrial Activity (MSGP) Forms

United States Environmental Protection Agency
1200 Pennsylvania Ave, NW Washington, DC 20460

Note: This is a "smart form", as you fill out the form, additional questions will appear that you will need to answer.

Permit Information

1. What action would you like to take? *

Submission of this Notice of Intent (NOI) constitutes notice that the operator identified in the Facility Operator Information section of this form requests authorization to discharge pursuant to the NPDES Stormwater Multi-Sector General Permit (MSGP) permit number identified in the Permit Information section of this form. Submission of this NOI also constitutes notice that the operator identified in the Facility Operator Information section of this form meets the eligibility conditions of Part 1.1 of the MSGP for the facility identified in the Facility Information section of this form. To obtain authorization, you must submit a complete and accurate NOI form. Discharges are not authorized if your NOI is incomplete or inaccurate or if you were never eligible for permit coverage.

Operator Name (Organization Name) *

Operator Name as Noted by the NOI Preparer

2. Select the state/territory where your facility is located *

3. Is your facility located on Indian Country lands? *

Yes

No

4. Are you requesting coverage as a "federal operator" as defined in Appendix A? *

Yes

No

5. Are you a new discharger or a new source as defined in Appendix A? *

Yes No

5a. Have stormwater discharges from your facility been covered previously under an NPDES permit? *

Yes No

Saa. Provide your most current NPDES ID (i.e., permit tracking number) if you had coverage under EPA's MSGP 2008 or the NPDES permit number if you had coverage under an EPA individual permit. *

NMR05GB21

6. Do you directly discharge to any of the waters of the U.S. that are designated by the state or tribal authority under its antidegradation policy as a Tier 3 water (Outstanding Natural Resource Water)? (See Appendix L)? Your project will be considered to discharge to a Tier 3 water if the first water of the US to which you discharge is identified by a state, tribe, or EPA as a Tier 3 water. For discharges that enter a storm sewer system prior to discharge, the first water of the US to which you discharge is the waterbody that receives the stormwater discharge from the storm sewer system. *

Yes No

7. Does your facility directly discharge to a Federal CERCLA site listed in Appendix P? For the purposes of this permit, a permittee discharges to a Federal CERCLA site if the discharge flows directly into the site through its own conveyance, or through a conveyance owned by others, such as a municipal separate storm sewer system. *

Yes No

8. Has the Stormwater Pollution Prevention Plan (SWPPP) been prepared in advance of filing this NOI, as required? *

Yes No

9. By indicating "Yes", I confirm that I understand that the MSGP only authorizes the allowable stormwater discharges in Part 1.1.2 and the allowable non-stormwater discharges in Part 1.1.3. Any discharges not expressly authorized under the MSGP are not covered by the MSGP and they cannot become authorized by disclosure to EPA and/or a state via this Notice of Intent to be covered by the permit or by any other means (e.g., in the Stormwater Pollution Prevention Plan or during an inspection). If any discharges requiring NPDES permit coverage other than the allowable stormwater and non-stormwater discharges listed in Parts 1.1.2 and 1.1.3 will be discharged, they must be covered under another NPDES permit. *

Yes No

10. Master Permit Number

NMR050000

A: Facility Operator Information

1. Operator Name (Organization Name) *

LOS ALAMOS NATIONAL LABORATORY

2. Street *

PO Box 1663

3. Supplemental Address

MS K490

4. City *

Los Alamos

8. Phone (10-digits, No dashes) *

5056671312

5. State *

NM

9. Extension

10. E-Mail *

hbenson@lanl.gov

6. Zip Code *

87545

7. Facility County or Similar Govt. Subdivision *

Los Alamos

Operator point of contact information

11. First Name *

Holly

12. Middle Initial

13. Last Name *

Wheeler

14. Professional Title *

Environmental Professional

B: Facility Information

1. Facility Name *

Los Alamos National Laboratory

Facility address same as facility operator address

2. Street/Location *

PO Box 1663

3. Supplemental Address

MS K490

4. City *

Los Alamos

5. State *

NM

6. Zip Code *

87545

7. Facility County or Similar Govt. Subdivision *

Los Alamos

Latitude/Longitude for the facility:

8. Latitude (Decimal Degrees) *

+ 35.872777

9. Longitude (Decimal Degrees) *

- 106.321127

10. Latitude/Longitude Data Source *

Other

11. Horizontal Reference Datum

WGS84

12. What is the ownership type of the facility *

Federal Facility (U.S. Government)

13. Estimated area of industrial activity at your facility exposed to stormwater (to the nearest quarter acre) *

126

Identify the applicable sector and subsector of your primary industrial activity (See Appendix D) that best represents the products produced or services rendered for which your facility is primarily engaged, as defined in the MSGP, and the 4-digit Standard Industrial Classification (SIC) code or 2-letter Activity Code:

15. Sector *

SECTOR AA: FABRICATED METAL PRODUCTS

16. Primary SIC Code *

3449: Miscellaneous Metal Work

17. Subsector

AA1: Fabricated Metal Products, Except Machinery and Transportation Equipment, and Coating, Engraving, and Allied Services.

18. Identify the applicable sector(s) of any co-located industrial activity for which you are requesting permit coverage.

Sector		Subsector *		Delete Sector
SECTOR P: LAND TRANSPORTATION AND WAREHOUSING		P1: Motor Freight Transportation and Warehousing		Delete Sector
Sector		Subsector *		Delete Sector
SECTOR K: HAZARDOUS WASTE TREATMENT, STORAGE, OR DISPOSAL FACILITIES		K1: Hazardous Waste Treatment, Storage, or Disposal Facilities, including those that are operati		Delete Sector
Sector		Subsector *		Delete Sector
SECTOR A: TIMBER PRODUCTS		A4: Wood Products; Not Elsewhere Classified		Delete Sector
Sector		Subsector *		Delete Sector
SECTOR D: ASPHALT PAVING AND ROOFING MATERIALS AND LUBRICANTS		D1: Asphalt Paving and Roofing Materials		Delete Sector
Sector		Subsector *		Delete Sector
SECTOR O: STEAM ELECTRIC GENERATING FACILITIES		O1: Steam Electric Generating Facilities, including coal handling sites		Delete Sector
Sector		Subsector *		Delete Sector
SECTOR F: PRIMARY METALS		F4: Nonferrous Foundries (Castings)		Delete Sector
Sector		Subsector *		Delete Sector
SECTOR N: SCRAP RECYCLING FACILITIES		N2: Source-separated Recycling Facility		Delete Sector
Add Sector				

22. Is your facility presently inactive and unstaffed? *

Yes No

C: Discharge Information

1. Does your facility discharge into any saltwater receiving waters? *

Yes No

2. What is the hardness of your receiving water(s) (see Appendix J) *

50-74.99 mg/L

3. Identify if the following Effluent Limitation Guideline(s) apply to any of your discharges

40 CFR Part/Subpart: Part 423	Eligible Discharges: Coal pile runoff at steam electric generating facilities	Affected MSGP Sector: O	New Source Date: 11/19/1982, 10/8/1974 ¹	Does your facility have any discharges subject to this effluent limitation guideline? *	<input type="radio"/> Yes <input checked="" type="radio"/> No
40 CFR Part/Subpart: Part 429, Subpart 1	Eligible Discharges: Discharges resulting from spray down or intentional wetting of logs at wet deck storage areas	Affected MSGP Sector: A	New Source Date: 1/26/1981	Does your facility have any discharges subject to this effluent limitation guideline? *	<input type="radio"/> Yes <input checked="" type="radio"/> No
40 CFR Part/Subpart: Part 443, Subpart A	Eligible Discharges: Runoff from asphalt emulsion facilities	Affected MSGP Sector: D	New Source Date: 7/28/1975	Does your facility have any discharges subject to this effluent limitation guideline? *	<input checked="" type="radio"/> Yes <input type="radio"/> No

Outfalls

4. List all of the stormwater outfalls from your facility. Each outfall must be identified by a unique 3-digit ID (e.g., 001, 002) or a 4-digit ID. Also provide the latitude and longitude in decimal degrees for each outfall.

A. Outfall ID * + B. Latitude (Decimal Degrees) * - C. Longitude (Decimal Degrees) *

Lookup Receiving Waters Information

Delete Outfall

(This button will prepopulate the receiving water information associated with your outfall on your form. You may edit the information that is returned if you believe it is incorrect)

If for any reason the Lookup Receiving Water Information button does not prepopulate your form with receiving waters information, you must manually enter the information on your form.

Outfall Section

1. Provide the name of the first water of the U.S that receives stormwater directly from the outfall and/or from the MS4 that the outfall discharges to. (You may edit the name of the water of the U.S. that was returned if incorrect). *

SANDIA CANYON (SIGMA CANYON TO NPDES OUTFALL 001)

2. Is the receiving water listed as impaired on the 303(d) list and in need of a TMDL? *

Yes No

4. List the pollutants that are causing the impairment:

Pollutant	Aluminum, total [as Al]				
	Delete Pollutant				
Pollutant	Copper, total [as Cu]				
	Delete Pollutant				
Pollutant	Alpha, total				
	Delete Pollutant				
Pollutant	PCB IN WATER COLUMN				
	Delete Pollutant				

Please select the cause group and pollutant for which the waterbody is impaired:

Cause Group * Pollutant *

Add Impairment Pollutant Associated with this Waterbody

3. Has a TMDL been completed for this receiving waterbody? *
- Yes No

Outfalls

4. List all of the stormwater outfalls from your facility. Each outfall must be identified by a unique 3-digit ID (e.g., 001, 002) or a 4-digit ID. Also provide the latitude and longitude in decimal degrees for each outfall.

A. Outfall ID *

B. Latitude (Decimal Degrees) *

C. Longitude (Decimal Degrees) *

Lookup Receiving Waters Information

Delete Outfall

(This button will prepopulate the receiving water information associated with your outfall on your form. You may edit the information that is returned if you believe it is incorrect)

- D. Substantially identical to Any Outfalls Listed Above? *
- Yes No

E. Substantially identical to outfall ID *

If for any reason the Lookup Receiving Water Information button does not prepopulate your form with receiving waters information, you must manually enter the information on your form.

5. Multiple Receiving Waters were returned for your outfall. Please select the receiving water that is associated with your outfall from this list: *

LOS ALAMOS CANYON (DP CANYON TO UPPER LANL BND)

Outfall Section

1. Provide the name of the first water of the U.S. that receives stormwater directly from the outfall and/or from the MSA that the outfall discharges to. (You may edit the name of the water of the U.S. that was returned if incorrect.) *

LOS ALAMOS CANYON (DP CANYON TO UPPER LANL BND)

2. Is the receiving water listed as impaired on the 303(d) list and in need of a TMDL? *

- Yes No

4. List the pollutants that are causing the impairment:

Pollutant

Aluminum, total [as Al]

Delete Pollutant

Pollutant

Alpha, total

Delete Pollutant

Pollutant

PCB IN WATER COLUMN

Delete Pollutant

Please select the cause group and pollutant for which the waterbody is impaired:

Cause Group *
MERCURY

Pollutant *
Mercury, total [as Hg]

Delete Pollutant

Add Impairment Pollutant Associated with this Waterbody

3. Has a TMDL been completed for this receiving waterbody? *
 Yes No

Outfalls

4. List all of the stormwater outfalls from your facility. Each outfall must be identified by a unique 3-digit ID (e.g., 001, 002) or a 4-digit ID. Also provide the latitude and longitude in decimal degrees for each outfall.

A. Outfall ID *
005

B. Latitude (Decimal Degrees) *
+ 35.873908

C. Longitude (Decimal Degrees) *
- 106.320709

Lookup Receiving Waters Information

Delete Outfall

(This button will prepopulate the receiving water information associated with your outfall on your form. You may edit the information that is returned if you believe it is incorrect)

D. Substantially Identical to Any Outfalls Listed Above? *
 Yes No

If for any reason the Lookup Receiving Water Information button does not prepopulate your form with receiving waters information, you must manually enter the information on your form.

Outfall Section

1. Provide the name of the first water of the U.S that receives stormwater directly from the outfall and/or from the MS4 that the outfall discharges to.
(You may edit the name of the water of the U.S. that was returned if incorrect.) *

SANDIA CANYON (SIGMA CANYON TO NPDES OUTFALL 001)

2. Is the receiving water listed as impaired on the 303(d) list and in need of a TMDL? *
 Yes No

4. List the pollutants that are causing the impairment:

Pollutant				
Aluminum, total [as Al]				
Delete Pollutant				
Pollutant				
Copper, total [as Cu]				
Delete Pollutant				

Pollutant
Alpha, total

Delete Pollutant

Pollutant
PCB IN WATER COLUMN

Delete Pollutant

Please select the cause group and pollutant for which the waterbody is impaired:

Cause Group *
METALS (OTHER THAN MERCURY)

Pollutant *
Thallium, total [as Tl]

Delete Pollutant

Add Impairment Pollutant Associated with this Waterbody

3. Has a TMDL been completed for this receiving waterbody? *
 Yes No

Outfalls

4. List all of the stormwater outfalls from your facility. Each outfall must be identified by a unique 3-digit ID (e.g., 001, 002) or a 4-digit ID. Also provide the latitude and longitude in decimal degrees for each outfall.

A. Outfall ID * B. Latitude (Decimal Degrees) * C. Longitude (Decimal Degrees) *
006 + 35.874002 - 106.319825

Lookup Receiving Waters Information

Delete Outfall

This button will prepopulate the receiving water information associated with your outfall on your form. You may edit the information that is returned if you believe it is incorrect.

D. Substantially identical to Any Outfalls Listed Above? * E. Substantially identical to outfall ID *
 Yes No 005

If for any reason the Lookup Receiving Water Information button does not prepopulate your form with receiving waters information, you must manually enter the information on your form.

Outfall Section

1. Provide the name of the first water of the U.S. that receives stormwater directly from the outfall and/or from the MSA that the outfall discharges to.
(You may edit the name of the water of the U.S. that was returned if incorrect.) *

SANDIA CANYON (SIGMA CANYON TO NPDES OUTFALL 001)

2. Is the receiving water listed as impaired on the 303(d) list and in need of a TMDL? *
 Yes No

4. List the pollutants that are causing the impairment:

Pollutant
Aluminum, total [as Al]

Delete Pollutant

Pollutant
Copper, total [as Cu]

Delete Pollutant

Pollutant
Alpha, total

Delete Pollutant

Pollutant
PCB IN WATER COLUMN

Delete Pollutant

Please select the cause group and pollutant for which the waterbody is impaired:

Cause Group * METALS (OTHER THAN MERCURY) Pollutant * Thallium, total [as Tl] Delete Pollutant

Add Impairment Pollutant Associated with this Waterbody

3. Has a TMDL been completed for this receiving waterbody? *
 Yes No

Outfalls

4. List all of the stormwater outfalls from your facility. Each outfall must be identified by a unique 3-digit ID (e.g., 001, 002) or a 4-digit ID. Also provide the latitude and longitude in decimal degrees for each outfall.

A. Outfall ID * 009 + B. Latitude (Decimal Degrees) * 35.874951 - C. Longitude (Decimal Degrees) * 106.319263

Lookup Receiving Waters Information
(This button will prepopulate the receiving water information associated with your outfall on your form. You may edit the information that is returned if you believe it is incorrect)

Delete Outfall

D. Substantially Identical to Any Outfalls Listed Above? *
 Yes No

If for any reason the Lookup Receiving Water Information button does not prepopulate your form with receiving waters information, you must manually enter the information on your form.

Outfall Section

1. Provide the name of the first water of the U S that receives stormwater directly from the outfall and/or from the MS4 that the outfall discharges to. (You may edit the name of the water of the U.S. that was returned if incorrect.) *
SANDIA CANYON (SIGMA CANYON TO NPDES OUTFALL 001)

2. Is the receiving water listed as impaired on the 303(d) list and in need of a TMDL? *
 Yes No

4. List the pollutants that are causing the impairment:

Pollutant
Aluminum, total [as Al]

Delete Pollutant

Pollutant
Copper, total [as Cu]

Delete Pollutant

Pollutant
Alpha, total

Delete Pollutant

Pollutant
PCB IN WATER COLUMN

Delete Pollutant

Please select the cause group and pollutant for which the waterbody is impaired:

Cause Group *
METALS (OTHER THAN MERCURY)

Pollutant *
Thallium, total [as Tl]

Delete Pollutant

Add Impairment Pollutant Associated with this Waterbody

3. Has a TMDL been completed for this receiving waterbody? *
 Yes No

Outfalls

4. List all of the stormwater outfalls from your facility. Each outfall must be identified by a unique 3-digit ID (e.g., 001, 002) or a 4-digit ID. Also provide the latitude and longitude in decimal degrees for each outfall.

A. Outfall ID *
007

B. Latitude (Decimal Degrees) * C. Longitude (Decimal Degrees) *

D. Substantially Identical to Any Outfalls Listed Above? * Yes No E. Substantially identical to outfall ID *

If for any reason the Lookup Receiving Water Information button does not prepopulate your form with receiving waters information, you must manually enter the information on your form.

Outfall Section

1. Provide the name of the first water of the U.S that receives stormwater directly from the outfall and/or from the MS4 that the outfall discharges to. (You may edit the name of the water of the U.S. that was returned if incorrect.) *

2. Is the receiving water listed as impaired on the 303(d) list and in need of a TMDL? *
 Yes No

4. List the pollutants that are causing the impairment:

Pollutant

Pollutant

Pollutant

Pollutant

Please select the cause group and pollutant for which the waterbody is impaired:

Cause Group *

Pollutant *

Add Impairment Pollutant Associated with this Waterbody

3. Has a TMDL been completed for this receiving waterbody? *

Yes No

Outfalls

4. List all of the stormwater outfalls from your facility. Each outfall must be identified by a unique 3-digit ID (e.g., 001, 002) or a 4-digit ID. Also provide the latitude and longitude in decimal degrees for each outfall.

A. Outfall ID * + B. Latitude (Decimal Degrees) * C. Longitude (Decimal Degrees) * E. Substantially identical to outfall ID *

Look up Receiving Waters Information

D. Substantially identical to Any Outfalls Listed Above? *

Yes No

If for any reason the Lookup Receiving Water Information button does not prepopulate your form with receiving waters information, you must manually enter the information on your form.

Outfall Section

1. Provide the name of the first water of the U.S that receives stormwater directly from the outfall and/or from the MSA that the outfall discharges to. (You may edit the name of the water of the U.S. that was returned if incorrect) *

2. Is the receiving water listed as impaired on the 303(d) list and in need of a TMDL? *

Yes No

4. List the pollutants that are causing the impairment:

Pollutant

Pollutant

Pollutant

Pollutant
PCB IN WATER COLUMN

Delete Pollutant

Please select the cause group and pollutant for which the waterbody is impaired:

Cause Group *
METALS (OTHER THAN MERCURY)

Pollutant *
Thallium, total [as Tl]

Delete Pollutant

Add Impairment Pollutant Associated with this Waterbody

3. Has a TMDL been completed for this receiving waterbody? *
 Yes No

Outfalls

4. List all of the stormwater outfalls from your facility. Each outfall must be identified by a unique 3-digit ID (e.g., 001, 002) or a 4-digit ID. Also provide the latitude and longitude in decimal degrees for each outfall.

A. Outfall ID *
010 + B. Latitude (Decimal Degrees) *
35.874014 - C. Longitude (Decimal Degrees) *
106.318428

Lookup Receiving Waters Information

Delete Outfall

(This button will prepopulate the receiving water information associated with your outfall on your form. You may edit the information that is returned if you believe it is incorrect)

D. Substantially Identical to Any Outfalls Listed Above? *
 Yes No E. Substantially identical to outfall ID *
009

If for any reason the Lookup Receiving Water Information button does not prepopulate your form with receiving waters information, you must manually enter the information on your form.

Outfall Section

1. Provide the name of the first water of the U.S that receives stormwater directly from the outfall and/or from the MSA that the outfall discharges to.
(You may edit the name of the water of the U.S. that was returned if incorrect) *

SANDIA CANYON (SIGMA CANYON TO NPDES OUTFALL 001)

2. Is the receiving water listed as impaired on the 303(d) list and in need of a TMDL? *
 Yes No

4. List the pollutants that are causing the impairment:

Pollutant
Aluminum, total [as Al]

Delete Pollutant

Pollutant
Copper, total [as Cu]

Delete Pollutant	
Pollutant	
Alpha, total	
Delete Pollutant	
Pollutant	
PCB IN WATER COLUMN	
Delete Pollutant	

Please select the cause group and pollutant for which the waterbody is impaired:

Cause Group * Pollutant *

Add Impairment Pollutant Associated with this Waterbody

3. Has a TMDL been completed for this receiving waterbody? *
 Yes No

Outfalls

4. List all of the stormwater outfalls from your facility. Each outfall must be identified by a unique 3-digit ID (e.g., 001, 002) or a 4-digit ID. Also provide the latitude and longitude in decimal degrees for each outfall.

A. Outfall ID *	<input type="text" value="011"/>	+	B. Latitude (Decimal Degrees) *	<input type="text" value="35.875560"/>	-	C. Longitude (Decimal Degrees) *	<input type="text" value="106.320764"/>	<input type="button" value="Lookup Receiving Waters Information"/>	<input type="button" value="Delete Outfall"/>
D. Substantially identical to Any Outfalls Listed Above? *								E. Substantially identical to outfall ID *	
<input checked="" type="radio"/> Yes <input type="radio"/> No								<input type="text" value="012"/>	

If for any reason the Lookup Receiving Water Information button does not prepopulate your form with receiving waters information, you must manually enter the information on your form.

Outfall Section

1. Provide the name of the first water of the U.S that receives stormwater directly from the outfall and/or from the MS4 that the outfall discharges to. (You may edit the name of the water of the U.S. that was returned if incorrect). *

2. Is the receiving water listed as impaired on the 303(d) list and in need of a TMDL? *

Yes No

4. List the pollutants that are causing the impairment:

Pollutant
Aluminum, total [as Al]

Delete Pollutant

Pollutant
Copper, total [as Cu]

Delete Pollutant

Pollutant
Alpha, total

Delete Pollutant

Pollutant
PCB IN WATER COLUMN

Delete Pollutant

Please select the cause group and pollutant for which the waterbody is impaired:

Cause Group *
METALS (OTHER THAN MERCURY)

Pollutant *
Thallium, total [as Tl]

Delete Pollutant

Add Impairment Pollutant Associated with this Waterbody

3. Has a TMDL been completed for this receiving waterbody? *

Yes

No

Outfalls

4. List all of the stormwater outfalls from your facility. Each outfall must be identified by a unique 3-digit ID (e.g., 001, 002) or a 4-digit ID. Also provide the latitude and longitude in decimal degrees for each outfall.

A. Outfall ID *
012

+

B. Latitude (Decimal Degrees) *
35.875506

-

C. Longitude (Decimal Degrees) *
106.320842

Lookup Receiving Waters Information

Delete Outfall

(This button will prepopulate the receiving water information associated with your outfall on your form. You may edit the information that is returned if you believe it is incorrect)

D. Substantially Identical to Any Outfalls Listed Above? *

Yes

No

If for any reason the Lookup Receiving Water Information button does not prepopulate your form with receiving waters information, you must manually enter the information on your form.

Outfall Section

1. Provide the name of the first water of the U.S. that receives stormwater directly from the outfall and/or from the MSA that the outfall discharges to. (You may edit the name of the water of the U.S. that was returned if incorrect.) *

SANDIA CANYON (SIGMA CANYON TO NPDES OUTFALL 001)

2. Is the receiving water listed as impaired on the 303(d) list and in need of a TMDL? *

Yes No

4. List the pollutants that are causing the impairment:

Pollutant

Aluminum, total [as Al]

Delete Pollutant

Pollutant

Copper, total [as Cu]

Delete Pollutant

Pollutant

Alpha, total

Delete Pollutant

Pollutant

PCB IN WATER COLUMN

Delete Pollutant

Please select the cause group and pollutant for which the waterbody is impaired:

Cause Group *

METALS (OTHER THAN MERCURY)

Pollutant *

Thallium, total [as Tl]

Delete Pollutant

Add Impairment Pollutant Associated with this Waterbody

3. Has a TMDL been completed for this receiving waterbody? *

Yes No

Outfalls

4. List all of the stormwater outfalls from your facility. Each outfall must be identified by a unique 3-digit ID (e.g., 001, 002) or a 4-digit ID. Also provide the latitude and longitude in decimal degrees for each outfall.

A. Outfall ID * + B. Latitude (Decimal Degrees) * - C. Longitude (Decimal Degrees) *

Lookup Receiving Waters Information

(This button will prepopulate the receiving water information associated with your outfall on your form. You may edit the information that is returned if you believe it is incorrect)

D. Substantially Identical to Any Outfalls Listed Above? * Yes No

If for any reason the Lookup Receiving Water Information button does not prepopulate your form with receiving waters information, you must manually enter the information on your form.

Outfall Section

1. Provide the name of the first water of the U.S that receives stormwater directly from the outfall and/or from the MS4 that the outfall discharges to. (You may edit the name of the water of the U.S. that was returned if incorrect.) *

2. Is the receiving water listed as impaired on the 303(d) list and in need of a TMDL? * Yes No

4. List the pollutants that are causing the impairment:

Please select the cause group and pollutant for which the waterbody is impaired:

Cause Group * Pollutant *

Please select the cause group and pollutant for which the waterbody is impaired:

Cause Group * Pollutant *

Please select the cause group and pollutant for which the waterbody is impaired:

Cause Group * Pollutant *

Add Impairment Pollutant Associated with this Waterbody

3. Has a TMDL been completed for this receiving waterbody? * Yes No

Outfalls

4. List all of the stormwater outfalls from your facility. Each outfall must be identified by a unique 3-digit ID (e.g., 001, 002) or a 4-digit ID. Also provide the latitude and longitude in decimal degrees for each outfall.

A. Outfall ID * + B. Latitude (Decimal Degrees) * - C. Longitude (Decimal Degrees) *

Lookup Receiving Waters Information

(This button will prepopulate the receiving water information associated with your outfall on your form. You may edit the information that is returned if you believe it is incorrect)

D. Substantially Identical to Any Outfalls Listed Above? *
 Yes No

If for any reason the Lookup Receiving Water Information button does not prepopulate your form with receiving waters information, you must manually enter the information on your form.

Outfall Section

1. Provide the name of the first water of the U.S that receives stormwater directly from the outfall and/or from the MSA that the outfall discharges to. (You may edit the name of the water of the U.S. that was returned if incorrect.) *
SANDIA CANYON (SIGMA CANYON TO NPDES OUTFALL 001)

2. Is the receiving water listed as impaired on the 303(d) list and in need of a TMDL? *
 Yes No

4. List the pollutants that are causing the impairment:

Pollutant
Aluminum, total [as Al]

Delete Pollutant

Pollutant
Copper, total [as Cu]

Delete Pollutant

Pollutant
Alpha, total

Delete Pollutant

Pollutant
PCB IN WATER COLUMN

Delete Pollutant

Please select the cause group and pollutant for which the waterbody is impaired:

Cause Group * METALS (OTHER THAN MERCURY) Pollutant * Thallium, total [as Tl]

Delete Pollutant

Add Impairment Pollutant Associated with this Waterbody

3. Has a TMDL been completed for this receiving waterbody? *
 Yes No

Outfalls

4. List all of the stormwater outfalls from your facility. Each outfall must be identified by a unique 3-digit ID (e.g., 001, 002) or a 4-digit ID. Also provide the latitude and longitude in decimal degrees for each outfall.

A. Outfall ID * + B. Latitude (Decimal Degrees) * C. Longitude (Decimal Degrees) *

D. Substantially Identical to Any Outfalls Listed Above? * Yes No E. Substantially identical to outfall ID *

Look up Receiving Waters Information
(This button will prepopulate the receiving water information associated with your outfall on your form. You may edit the information that is returned if you believe it is incorrect)

Delete Outfall

If for any reason the Lookup Receiving Water Information button does not prepopulate your form with receiving waters information, you must manually enter the information on your form.

Outfall Section

1. Provide the name of the first water of the U.S that receives stormwater directly from the outfall and/or from the MS4 that the outfall discharges to. (You may edit the name of the water of the U.S. that was returned if incorrect.) *

MORTANDAD CANYON (WITHIN LANI)

2. Is the receiving water listed as impaired on the 303(d) list and in need of a TMDL? * Yes No

4. List the pollutants that are causing the impairment:

Please select the cause group and pollutant for which the waterbody is impaired:

Cause Group * Pollutant * Delete Pollutant

Please select the cause group and pollutant for which the waterbody is impaired:

Cause Group * Pollutant * Delete Pollutant

Please select the cause group and pollutant for which the waterbody is impaired:

Cause Group * Pollutant * Delete Pollutant

Please select the cause group and pollutant for which the waterbody is impaired:

Cause Group * Pollutant * Delete Pollutant

Add Impairment Pollutant Associated with this Waterbody

3. Has a TMDL been completed for this receiving waterbody? * Yes No

Outfalls

4. List all of the stormwater outfalls from your facility. Each outfall must be identified by a unique 3-digit ID (e.g., 001, 002) or a 4-digit ID. Also provide the latitude and longitude in decimal degrees for each outfall.

A. Outfall ID *

B. Latitude (Decimal Degrees) *

C. Longitude (Decimal Degrees) *

Lookup Receiving Waters Information

Delete Outfall

(This button will prepopulate the receiving water information associated with your outfall on your form. You may edit the information that is returned if you believe it is incorrect)

D. Substantially identical to Any Outfalls Listed Above? *

Yes No

E. Substantially identical to outfall ID *

If for any reason the Lookup Receiving Water Information button does not prepopulate your form with receiving waters information, you must manually enter the information on your form.

Outfall Section

1. Provide the name of the first water of the U.S that receives stormwater directly from the outfall and/or from the MSA that the outfall discharges to. (You may edit the name of the water of the U.S. that was returned if incorrect.) *

2. Is the receiving water listed as impaired on the 303(d) list and in need of a TMDL? *

Yes No

4. List the pollutants that are causing the impairment:

Please select the cause group and pollutant for which the waterbody is impaired:

Cause Group *

Pollutant *

Delete Pollutant

Please select the cause group and pollutant for which the waterbody is impaired:

Cause Group *

Pollutant *

Delete Pollutant

Please select the cause group and pollutant for which the waterbody is impaired:

Cause Group *

Pollutant *

Delete Pollutant

Please select the cause group and pollutant for which the waterbody is impaired:

Cause Group *

Pollutant *

Delete Pollutant

Add Impairment Pollutant Associated with this Waterbody

3. Has a TMDL been completed for this receiving waterbody? *

Yes No

Outfalls

4. List all of the stormwater outfalls from your facility. Each outfall must be identified by a unique 3-digit ID (e.g., 001, 002) or a 4-digit ID. Also provide the latitude and longitude in decimal degrees for each outfall.

A. Outfall ID *

B. Latitude (Decimal Degrees) *

C. Longitude (Decimal Degrees) *

Lookup Receiving Waters Information

Delete Outfall

(This button will prepopulate the receiving water information associated with your outfall on your form. You may edit the information that is returned if you believe it is incorrect)

D. Substantially Identical to Any Outfalls Listed Above? *

Yes No

E. Substantially identical to outfall ID *

If for any reason the Lookup Receiving Water Information button does not prepopulate your form with receiving waters information, you must manually enter the information on your form.

Outfall Section

1. Provide the name of the first water of the U.S that receives stormwater directly from the outfall and/or from the MS4 that the outfall discharges to. (You may edit the name of the water of the U.S. that was returned if incorrect.) *

2. Is the receiving water listed as impaired on the 303(d) list and in need of a TMDL? * Yes No

4. List the pollutants that are causing the impairment:

Please select the cause group and pollutant for which the waterbody is impaired:

Cause Group *

Pollutant *

Delete Pollutant

Please select the cause group and pollutant for which the waterbody is impaired:

Cause Group *

Pollutant *

Delete Pollutant

Please select the cause group and pollutant for which the waterbody is impaired:

Cause Group *

Pollutant *

Delete Pollutant

Please select the cause group and pollutant for which the waterbody is impaired:

Cause Group *

Pollutant *

Delete Pollutant

Add Impairment Pollutant Associated with this Waterbody

3. Has a TMDL been completed for this receiving waterbody? * Yes No

Outfalls

4. List all of the stormwater outfalls from your facility. Each outfall must be identified by a unique 3-digit ID (e.g., 001, 002) or a 4-digit ID. Also provide the latitude and longitude in decimal degrees for each outfall.

A. Outfall ID * + B. Latitude (Decimal Degrees) * C. Longitude (Decimal Degrees) *

(This button will prepopulate the receiving water information associated with your outfall on your form. You may edit the information that is returned if you believe it is incorrect)

D. Substantially Identical to Any Outfalls Listed Above? * Yes No E. Substantially identical to outfall ID *

If for any reason the Lookup Receiving Water Information button does not prepopulate your form with receiving waters information, you must manually enter the information on your form.

Outfall Section

1. Provide the name of the first water of the U.S that receives stormwater directly from the outfall and/or from the MSA that the outfall discharges to. (You may edit the name of the water of the U.S. that was returned if incorrect.) *

2. Is the receiving water listed as impaired on the 303(d) list and in need of a TMDL? * Yes No

4. List the pollutants that are causing the impairment:

Please select the cause group and pollutant for which the waterbody is impaired:

Cause Group * Pollutant *

Please select the cause group and pollutant for which the waterbody is impaired:

Cause Group * Pollutant *

Please select the cause group and pollutant for which the waterbody is impaired:

Cause Group * Pollutant *

Please select the cause group and pollutant for which the waterbody is impaired:

Cause Group * Pollutant *

Please select the cause group and pollutant for which the waterbody is impaired:

Cause Group * Pollutant *

Add Impairment Pollutant Associated with this Waterbody

3. Has a TMDL been completed for this receiving waterbody? *
- Yes No

Outfalls

4. List all of the stormwater outfalls from your facility. Each outfall must be identified by a unique 3-digit ID (e.g., 001, 002) or a 4-digit ID. Also provide the latitude and longitude in decimal degrees for each outfall.

A. Outfall ID * + B. Latitude (Decimal Degrees) * C. Longitude (Decimal Degrees) *

E. Substantially identical to outfall ID *

E. Substantially identical to outfall ID *

Lookkup Receiving Waters Information

(This button will prepopulate the receiving water information associated with your outfall on your form. You may edit the information that is returned if you believe it is incorrect)

Delete Outfall

- D. Substantially identical to Any Outfalls Listed Above? *
- Yes No

If for any reason the Lookkup Receiving Water Information button does not prepopulate your form with receiving waters information, you must manually enter the information on your form.

Outfall Section

1. Provide the name of the first water of the U.S that receives stormwater directly from the outfall and/or from the MSA that the outfall discharges to. (You may edit the name of the water of the U.S. that was returned if incorrect). *
- SANDIA CANYON (SIGMA CANYON TO NPDES OUTFALL 001)

2. Is the receiving water listed as impaired on the 303(d) list and in need of a TMDL? *
- Yes No

4. List the pollutants that are causing the impairment:

Please select the cause group and pollutant for which the waterbody is impaired:

Cause Group * METALS (OTHER THAN MERCURY) Pollutant * Aluminum, total [as Al] Delete Pollutant

Please select the cause group and pollutant for which the waterbody is impaired:

Cause Group * METALS (OTHER THAN MERCURY) Pollutant * Copper, total [as Cu] Delete Pollutant

Please select the cause group and pollutant for which the waterbody is impaired:

Cause Group * METALS (OTHER THAN MERCURY) Pollutant * Thallium, total [as Tl] Delete Pollutant

Please select the cause group and pollutant for which the waterbody is impaired:

Cause Group * POLYCHLORINATED BIPHENYLS (PCBS) Pollutant * Polychlorinated biphenyls [PCBS] Delete Pollutant

Please select the cause group and pollutant for which the waterbody is impaired:

Cause Group *
RADIATION

Pollutant *
Alpha, total

Delete Pollutant

Add Impairment Pollutant Associated with this Waterbody

3. Has a TMDL been completed for this receiving waterbody? *
 Yes No

Outfalls

4. List all of the stormwater outfalls from your facility. Each outfall must be identified by a unique 3-digit ID (e.g., 001, 002) or a 4-digit ID. Also provide the latitude and longitude in decimal degrees for each outfall.

A. Outfall ID *
019 + B. Latitude (Decimal Degrees) *
35.872668

C. Longitude (Decimal Degrees) *
106.318428

Lookup Receiving Waters Information

Delete Outfall

(This button will prepopulate the receiving water information associated with your outfall on your form. You may edit the information that is returned if you believe it is incorrect)

D. Substantially identical to Any Outfalls Listed Above? *
 Yes No

E. Substantially identical to outfall ID *
018

If for any reason the Lookup Receiving Water Information button does not prepopulate your form with receiving waters information, you must manually enter the information on your form.

Outfall Section

1. Provide the name of the first water of the U.S that receives stormwater directly from the outfall and/or from the MS4 that the outfall discharges to. (You may edit the name of the water of the U.S. that was returned if incorrect.) *

SANDIA CANYON (SIGMA CANYON TO NPDES OUTFALL 001)

2. Is the receiving water listed as impaired on the 303(d) list and in need of a TMDL? *
 Yes No

4. List the pollutants that are causing the impairment:

Please select the cause group and pollutant for which the waterbody is impaired:

Cause Group *
METALS (OTHER THAN MERCURY)

Pollutant *
Aluminum, total [as Al]

Delete Pollutant

Please select the cause group and pollutant for which the waterbody is impaired:

Cause Group *
METALS (OTHER THAN MERCURY)

Pollutant *
Copper, total [as Cu]

Delete Pollutant

Please select the cause group and pollutant for which the waterbody is impaired:

Cause Group *
POLYCHLORINATED BIPHENYLS (PCBS)

Pollutant *
Polychlorinated biphenyls [PCBs]

Delete Pollutant

Please select the cause group and pollutant for which the waterbody is impaired:

Cause Group *

METALS (OTHER THAN MERCURY)

Pollutant *

Thallium, total [as Tl]

Delete Pollutant

Please select the cause group and pollutant for which the waterbody is impaired:

Cause Group *

RADIATION

Pollutant *

Alpha, total

Delete Pollutant

Add Impairment Pollutant Associated with this Waterbody

3. Has a TMDL been completed for this receiving waterbody? *

Yes No

Outfalls

4. List all of the stormwater outfalls from your facility. Each outfall must be identified by a unique 3-digit ID (e.g., 001, 002) or a 4-digit ID. Also provide the latitude and longitude in decimal degrees for each outfall.

A. Outfall ID *

051

+

B. Latitude (Decimal Degrees) *

35.830145

-

C. Longitude (Decimal Degrees) *

106.242675

Lookup Receiving Waters Information

Delete Outfall

(This button will prepopulate the receiving water information associated with your outfall on your form. You may edit the information that is returned if you believe it is incorrect)

D. Substantially Identical to Any Outfalls Listed Above? *

Yes No

If for any reason the Lookup Receiving Water Information button does not prepopulate your form with receiving waters information, you must manually enter the information on your form.

Outfall Section

1. Provide the name of the first water of the U.S that receives stormwater directly from the outfall and/or from the MSA that the outfall discharges to. (You may edit the name of the water of the U.S. that was returned if incorrect). *

PAJARITO CANYON (IN LANL BELOW ARROYO DE LA DELFE)

2. Is the receiving water listed as impaired on the 303(d) list and in need of a TMDL? *

Yes No

4. List the pollutants that are causing the impairment:

Please select the cause group and pollutant for which the waterbody is impaired:

Cause Group *

METALS (OTHER THAN MERCURY)

Pollutant *

Aluminum, total [as Al]

Delete Pollutant

Please select the cause group and pollutant for which the waterbody is impaired:

Cause Group *

METALS (OTHER THAN MERCURY)

Pollutant *

Copper, total [as Cu]

Delete Pollutant

Please select the cause group and pollutant for which the waterbody is impaired:

Cause Group * Pollutant *

Add Impairment Pollutant Associated with this Waterbody

3. Has a TMDL been completed for this receiving waterbody? *
 Yes No

Outfalls

4. List all of the stormwater outfalls from your facility. Each outfall must be identified by a unique 3-digit ID (e.g., 001, 002) or a 4-digit ID. Also provide the latitude and longitude in decimal degrees for each outfall.

A. Outfall ID *	<input type="text" value="072"/>	<input type="text" value="+"/> +	B. Latitude (Decimal Degrees) *	<input type="text" value="35.832885"/>	<input type="text" value="-"/> -	C. Longitude (Decimal Degrees) *	<input type="text" value="106.239443"/>	<input type="button" value="Lookup Receiving Waters Information"/>	<input type="button" value="Delete Outfall"/>
-----------------	----------------------------------	----------------------------------	---------------------------------	----------------------------------------	----------------------------------	----------------------------------	-----------------------------------------	--------------------------------------------------------------------	-----------------------------------------------

(This button will prepopulate the receiving water information associated with your outfall on your form. You may edit the information that is returned if you believe it is incorrect)

D. Substantially identical to Any Outfalls Listed Above? *
 Yes No

If for any reason the Lookup Receiving Water Information button does not prepopulate your form with receiving waters information, you must manually enter the information on your form.

Outfall Section

1. Provide the name of the first water of the U.S that receives stormwater directly from the outfall and/or from the MS4 that the outfall discharges to. (You may edit the name of the water of the U.S. that was returned if incorrect.) *

2. Is the receiving water listed as impaired on the 303(d) list and in need of a TMDL? *
 Yes No

4. List the pollutants that are causing the impairment:

Please select the cause group and pollutant for which the waterbody is impaired:

Cause Group * Pollutant *

Please select the cause group and pollutant for which the waterbody is impaired:

Cause Group * Pollutant *

Please select the cause group and pollutant for which the waterbody is impaired:

Cause Group * Pollutant *

Add Impairment Pollutant Associated with this Waterbody

3. Has a TMDL been completed for this receiving waterbody? *
 Yes No

Outfalls

4. List all of the stormwater outfalls from your facility. Each outfall must be identified by a unique 3-digit ID (e.g., 001, 002) or a 4-digit ID. Also provide the latitude and longitude in decimal degrees for each outfall.

A. Outfall ID * + B. Latitude (Decimal Degrees) *
C. Longitude (Decimal Degrees) *

(This button will prepopulate the receiving water information associated with your outfall on your form. You may edit the information that is returned if you believe it is incorrect)

D. Substantially Identical to Any Outfalls Listed Above? *
 Yes No

If for any reason the Lookup Receiving Water Information button does not prepopulate your form with receiving waters information, you must manually enter the information on your form.

Outfall Section

1. Provide the name of the first water of the U.S that receives stormwater directly from the outfall and/or from the MS4 that the outfall discharges to. (You may edit the name of the water of the U.S. that was returned if incorrect.) *

2. Is the receiving water listed as impaired on the 303(d) list and in need of a TMDL? *
 Yes No

4. List the pollutants that are causing the impairment:

Please select the cause group and pollutant for which the waterbody is impaired:

Cause Group * Pollutant *

Please select the cause group and pollutant for which the waterbody is impaired:

Cause Group * Pollutant *

Please select the cause group and pollutant for which the waterbody is impaired:

Cause Group * Pollutant *

Please select the cause group and pollutant for which the waterbody is impaired:

Cause Group * Pollutant *

Please select the cause group and pollutant for which the waterbody is impaired:

Cause Group * RADIATION	Pollutant * Alpha, total
----------------------------	-----------------------------

Add Impairment Pollutant Associated with this Waterbody

Delete Pollutant

3. Has a TMDL been completed for this receiving waterbody? *
 Yes No

Add Another Outfall

Provide the following information about your outfall latitude longitude.

5. Latitude/Longitude Data Source *
GPS

6. Horizontal Reference Datum
NAD83

7. Does your facility discharge into a Municipal Separate Storm Sewer System (MS4)? *
 Yes No

8. Do you discharge to any of the waters of the U.S. that are designated by the state or tribal authority under its antidegradation policy as a Tier 2 (or Tier 2.5) water (water quality exceeds levels necessary to support propagation of fish, shellfish, and wildlife and recreation in and on the water) (See Appendix L)? *
 Yes No

D: Stormwater Pollution Prevention Plan (SWPPP) Information

SWPPP Contact Information

1. First Name *
Holly

2. Middle Initial
[]

3. Last Name *
Wheeler

4. Professional Title *
Environmental Professional

5. Phone (10-digits; No dashes) *
5056671312

6. Extension
[]

7. E-Mail *
hbenson@lanl.gov

8. Your current SWPPP or certain information from your SWPPP must be made available through one of the following two options. Select one of the options and provide the required information. *
Note: You are not required to post any confidential business information (CBI) or restricted information (as defined in Appendix A) (such information may be redacted), but you must clearly identify those portions of the SWPPP that are being withheld from public access.

Option 1: Maintain a Current Copy of your SWPPP on an Internet page (Universal Resource Locator or URL).

Provide the web address URL. *
eprr.lanl.gov

Option 2: Provide the following information from your SWPPP.

E: Endangered Species Protection

1. Using the instructions in Appendix E of the MSGP, under which endangered species criterion listed in Part 1.1.4.5 are you eligible for coverage under this permit? *

Criterion D – A separate ESA section 7 consultation has been completed

2. Provide a brief summary of the basis for the criterion selected in Appendix E (e.g., communication with U.S. Fish and Wildlife Service or National Marine Fisheries Service to determine no species in action area; implementation of controls approved by EPA and the Services). *

Direct consultation with the U.S. Fish and Wildlife Service and corresponding development and implementation of a facility-specific Habitat Management Plan.

You must attach copies of any letters or other communications with the U.S. Fish and Wildlife Service or National Marine Fisheries Service on the attachments screen after you click "Submit Now"

F: Historic Preservation

1. If your facility is not located in Indian country lands, is your facility located on a property of religious or cultural significance to an Indian tribe? *

Yes No

1a. If yes, provide the name of the Indian tribe associated with the property. *

San Ildefonso Pueblo

2. Using the instructions in Appendix F of the MSGP, under which historic properties preservation criterion listed in Part 1.1.4.7 are you eligible for coverage under this permit? *

Criterion B - Subsurface stormwater controls will not affect historic properties

Certification Information

I certify under penalty of law that this document and all attachments were prepared under my direction or supervision in accordance with a system designed to assure that qualified personnel properly gather and evaluate the information submitted. Based on my inquiry of the person or persons who manage the system, or those persons directly responsible for gathering the information, the information submitted is, to the best of my knowledge and belief, true, accurate, and complete. I am aware that there are significant penalties for submitting false information, including the possibility of fine and imprisonment for knowing violations. 40 CFR 1.22.22 (d)

Certifier E-Mail *

ADORRIES@LANL.GOV

Form Action *

Approve



Environmental Protection Division
Environmental Compliance Programs (ENV-CP)
PO Box 1663, K490
Los Alamos, New Mexico 87545
(505) 667-0666

Date: **NOV 24 2015**
Symbol: ENV-DO-15-0328
LA-UR: 15-29016
Locates Action No.: N/A

U.S. Environmental Protection Agency
Office of Water, Water Permits Division
Mail Code 4203M, ATTN: MSGP Reports
1200 Pennsylvania Avenue, NW
Washington, D.C. 20460

To Whom It May Concern:

Subject: National Pollutant Discharge Elimination System (NPDES) Permit Tracking No. NMR05GB21, Multi-Sector General Permit (MSGP) 2015 Comprehensive Site Inspection Documentation

The purpose of this letter is to notify EPA that Los Alamos National Security (LANS) conducted its Comprehensive Site Inspection at Los Alamos National Laboratory September 8 through 29, 2015, in accordance with Part 4.3 of the 2008 MSGP. On October 3, 2015, the LANS authorization to discharge under the 2015 MSGP became effective. The 2015 Annual Report would have been due on November 13, 2015 (45 days after the last day of the inspection) under the 2008 MSGP. However, due to coverage under the new 2015 MSGP superseding the 2008 requirements, LANS will provide the information collected from the 2015 Comprehensive Site Inspection and other required documentation identified in Part 7.5 of the 2015 MSGP in the 2015 Annual Report to be submitted by January 30th 2016. This Report will contain the following:

- A summary of the past year's routine facility inspection documentation (2015 MSGP Part 3.1.2) from September 1, 2015 through the end of 2015 calendar year;
- A summary of the past years quarterly visual assessment documentation (2015 MSGP Part 3.2.2);
- For any four-sample (minimum) average benchmark monitoring exceedance, if after reviewing the selection, design, installation, and implementation of control measures and considering whether any modifications are necessary to meet the effluent limits in the permit, a determination is made that no further pollutant reductions are technologically available and economically practicable and

achievable in light of best industry practice, the rationale for no further reductions being achievable (2015 MSGP Part 6.2.1.2); and

- A summary of the past year's corrective action documentation (2015 MSGP Part 4.4) from September 1, 2015 through the end of the 2015 calendar year.

The Annual Report will be signed and certified in accordance with Appendix B, Subsection 11. Please contact Terrill W. Lemke at (505) 665-2397 or Holly Wheeler at (505) 667-1312 if you have questions.

Sincerely,



Anthony R. Grieggs
Group Leader
Environmental Compliance Programs (ENV-CP)
Los Alamos National Security, LLC

ARG:TWL:HLW/lm

Cy: Nasim Jahan, USEPA/Region 6, Dallas, TX, (E-File)
Bruce Yurdin, NMED/SWQB, Santa Fe, NM, (E-File)
Michelle Hunter, NMED/GWQB, Santa Fe, NM, (E-File)
Gene E. Turner, LASO-NS-LP, (E-File)
Jordan Arnsward, LASO-NS-PI, (E-File)
Kirsten Laskey, LASO-SUP, (E-File)
Craig Leasure, PADOPS, (E-File)
Amy E. De Palma, PADOPS, (E-File)
Michael T. Brandt, ADESH, (E-File)
Raeanna Sharp-Geiger, ADESH, (E-File)
Alison M. Dorries, ENV-DO, (E-File)
Terrill W. Lemke, ENV-CP, (E-File)
Holly L. Wheeler, ENV-CP, (E-File)
lasomailbox@nnsa.doe.gov, (E-File)
locatesteam@lanl.gov, (E-File)
env-correspondence@lanl.gov

APPENDIX D

Non-Stormwater Discharge Certification

NON-STORM WATER DISCHARGE

ASSESSMENT AND CERTIFICATION

Completed

by: Jillian Bursin

Title: DEP, CISEC

Date: 8/20/15

Date of Evaluation	Outfall Directly Observed During the Test (Location)	Identify Potential Significant Sources of Non-Storm Water	Method Used to Test or Evaluate Discharge	Is Non-Storm Water Present?	How Often?	Describe Results from Test for the Presence of Non-Storm Water Discharge
8/20/15	002, 003	None	Visual	No	N/A	None Present

I certify under penalty of law that this document and all attachments were prepared under my direction or supervision in accordance with a system designed to assure that qualified personnel properly gather and evaluate the information submitted. Based on my inquiry of the person or persons who manage the system or those persons directly responsible for gathering the information, the information submitted is, to the best of my knowledge and belief, true, accurate, and completed. I am aware that there are significant penalties for submitting false information, including the possibility of fine and imprisonment for knowing violations.

Name &

Official Title: Jillian Bursin, DEP, CISEC

Signature: Jillian Bursin

Date Signed: 8/20/15

APPENDIX E
SWPPP Amendment Log

APPENDIX F

Facility Inspections:

Inspection Forms and Completed Reports for:
Monthly Routine Inspections
Quarterly Visual Assessments

Stormwater Industrial Routine Facility Inspection Report

General Information			
Facility Name	TA-3-38 Metals Fabrication Shop		
NPDES Tracking No.	NMR050000		
Date of Inspection	12/17/2015	Start/End Time	1:00-1:15 p.m.
Inspector's Name(s)	Jillian Burgin [with Tom Chavez (LOG-SUP) & Bob Aitken DSESH-ADPM]		
Inspector's Title(s)	DEP/CISEC		
Inspector's Contact Information	665-1893		
Inspector's Qualifications	CISEC (See SWPPP)		
Weather Information			
Weather at time of this inspection?			
<input checked="" type="checkbox"/> Clear <input type="checkbox"/> Cloudy <input type="checkbox"/> Rain <input type="checkbox"/> Sleet <input type="checkbox"/> Fog <input type="checkbox"/> Snow <input type="checkbox"/> High Winds <input type="checkbox"/> Other: Temperature: 26° F (Some snow and ice present in parking lot and material storage areas from recent snow storms).			
Have any previously unidentified discharges of pollutants occurred since the last inspection? <input type="checkbox"/> Yes <input checked="" type="checkbox"/> No			
If yes, describe: N/A			
Are there any discharges occurring at the time of inspection? <input type="checkbox"/> Yes <input checked="" type="checkbox"/> No			
If yes, describe: N/A			

Control Measures

- Number the structural stormwater control measures identified in your SWPPP on your site map and list them below (add as many control measures as are implemented on-site). Carry a copy of the numbered site map with you during your inspections. This list will ensure that you are inspecting all required control measures at your facility.
- Describe corrective actions initiated, date completed, and note the person that completed the work in the Corrective Action Log.

	Structural Control Measure	Control Measure is Operating Effectively?	If No, In Need of Maintenance, Repair, or Replacement?	Corrective Action Needed and Notes (identify needed maintenance and repairs, or any failed control measures that need replacement)
1	Asphalt berming	<input checked="" type="checkbox"/> Yes <input type="checkbox"/> No	<input type="checkbox"/> Maintenance <input type="checkbox"/> Repair <input type="checkbox"/> Replacement	N/A (Good Condition)
2	Covered Metal Storage Racks	<input checked="" type="checkbox"/> Yes <input type="checkbox"/> No	<input type="checkbox"/> Maintenance <input type="checkbox"/> Repair <input type="checkbox"/> Replacement	N/A (All metals covered)
3	Metal Recycle Bins (Covered)	<input checked="" type="checkbox"/> Yes <input type="checkbox"/> No	<input type="checkbox"/> Maintenance <input type="checkbox"/> Repair <input type="checkbox"/> Replacement	N/A (Covered)
4	Heavy Duty Tarps	<input checked="" type="checkbox"/> Yes <input type="checkbox"/> No	<input type="checkbox"/> Maintenance <input type="checkbox"/> Repair <input type="checkbox"/> Replacement	N/A (Good Condition)
5	Spill Control - Parking Areas	<input checked="" type="checkbox"/> Yes <input type="checkbox"/> No	<input type="checkbox"/> Maintenance <input type="checkbox"/> Repair <input type="checkbox"/> Replacement	No spills observed at the time of inspection or reported since previous inspection.

Areas of Industrial Materials or Activities exposed to stormwater

Below are some general areas that should be assessed during routine inspections. Customize this list as needed for the specific types of industrial materials or activities at your facility.

	Area/Activity	Inspected?	Controls Adequate (appropriate, effective, and operating)?	Corrective Action Needed and Notes
1	Material loading/unloading and storage areas	<input checked="" type="checkbox"/> Yes <input type="checkbox"/> No <input type="checkbox"/> N/A	<input checked="" type="checkbox"/> Yes <input type="checkbox"/> No	N/A
2	Equipment operations and maintenance areas	<input type="checkbox"/> Yes <input type="checkbox"/> No <input checked="" type="checkbox"/> N/A	<input type="checkbox"/> Yes <input type="checkbox"/> No	N/A
3	Fueling areas	<input type="checkbox"/> Yes <input type="checkbox"/> No <input checked="" type="checkbox"/> N/A	<input type="checkbox"/> Yes <input type="checkbox"/> No	N/A
4	Outdoor vehicle and equipment washing areas	<input type="checkbox"/> Yes <input type="checkbox"/> No <input checked="" type="checkbox"/> N/A	<input type="checkbox"/> Yes <input type="checkbox"/> No	N/A
5	Waste handling and disposal areas	<input type="checkbox"/> Yes <input type="checkbox"/> No <input checked="" type="checkbox"/> N/A	<input type="checkbox"/> Yes <input type="checkbox"/> No	N/A
6	Erodible areas/construction	<input type="checkbox"/> Yes <input type="checkbox"/> No <input checked="" type="checkbox"/> N/A	<input type="checkbox"/> Yes <input type="checkbox"/> No	N/A
7	Non-stormwater/ illicit connections	<input type="checkbox"/> Yes <input type="checkbox"/> No <input checked="" type="checkbox"/> N/A	<input type="checkbox"/> Yes <input type="checkbox"/> No	N/A
8	Salt storage piles or pile containing salt	<input type="checkbox"/> Yes <input type="checkbox"/> No <input checked="" type="checkbox"/> N/A	<input type="checkbox"/> Yes <input type="checkbox"/> No	N/A
9	Dust generation and vehicle tracking	<input type="checkbox"/> Yes <input type="checkbox"/> No <input checked="" type="checkbox"/> N/A	<input type="checkbox"/> Yes <input type="checkbox"/> No	N/A
10	(Other)	<input type="checkbox"/> Yes <input type="checkbox"/> No <input type="checkbox"/> N/A	<input type="checkbox"/> Yes <input type="checkbox"/> No	
11	(Other)	<input type="checkbox"/> Yes <input type="checkbox"/> No <input type="checkbox"/> N/A	<input type="checkbox"/> Yes <input type="checkbox"/> No	
12	(Other)	<input type="checkbox"/> Yes <input type="checkbox"/> No <input type="checkbox"/> N/A	<input type="checkbox"/> Yes <input type="checkbox"/> No	

Non-Compliance

Describe any incidents of non-compliance observed and not described above:

The yard was clean and in good condition. There were no incidents of non-compliance observed.

FSR (#144268) has been placed to clean the sludge out of the trench drain sump. The Petro Plug for the outlet pipe has been removed for winter and will be reinstalled when the drain needs to be pumped.

Additional Control Measures

Describe any additional control measures needed to comply with the permit requirements:

The sludge in the trench drain sump needs to be removed.

Notes

Use this space for any additional notes or observations from the inspection:

N/A

CERTIFICATION STATEMENT

"I certify under penalty of law that this document and all attachments were prepared under my direction or supervision in accordance with a system designed to assure that qualified personnel properly gathered and evaluated the information submitted. Based on my inquiry of the person or persons who manage the system, or those persons directly responsible for gathering the information, the information submitted is, to the best of my knowledge and belief, true, accurate, and complete. I am aware that there are significant penalties for submitting false information, including the possibility of fine and imprisonment for knowing violations."

Print name and title: Phil Romero, ESH Manager

Signature: _____

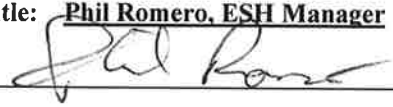

Date: _____

12/17/15

Stormwater Industrial Routine Facility Inspection Report

General Information			
Facility Name	TA-3-38 Metals Fabrication Shop		
NPDES Tracking No.	NMR050000		
Date of Inspection	11/23/2015	Start/End Time	1:15-1:35 p.m.
Inspector's Name(s)	Jillian Burgin [with Tom Chavez (LOG-SUP)]		
Inspector's Title(s)	DEP/CISEC		
Inspector's Contact Information	665-1893		
Inspector's Qualifications	CISEC (See SWPPP)		
Weather Information			
Weather at time of this inspection?			
<input checked="" type="checkbox"/> Clear <input type="checkbox"/> Cloudy <input type="checkbox"/> Rain <input type="checkbox"/> Sleet <input type="checkbox"/> Fog <input type="checkbox"/> Snow <input type="checkbox"/> High Winds <input type="checkbox"/> Other: Temperature: 49° F			
Have any previously unidentified discharges of pollutants occurred since the last inspection? <input type="checkbox"/> Yes <input checked="" type="checkbox"/> No If yes, describe: N/A			
Are there any discharges occurring at the time of inspection? <input type="checkbox"/> Yes <input checked="" type="checkbox"/> No If yes, describe: N/A			

Control Measures

- Number the structural stormwater control measures identified in your SWPPP on your site map and list them below (add as many control measures as are implemented on-site). Carry a copy of the numbered site map with you during your inspections. This list will ensure that you are inspecting all required control measures at your facility.
- Describe corrective actions initiated, date completed, and note the person that completed the work in the Corrective Action Log.

	Structural Control Measure	Control Measure is Operating Effectively?	If No, In Need of Maintenance, Repair, or Replacement?	Corrective Action Needed and Notes (identify needed maintenance and repairs, or any failed control measures that need replacement)
1	Asphalt berming	<input checked="" type="checkbox"/> Yes <input type="checkbox"/> No	<input type="checkbox"/> Maintenance <input type="checkbox"/> Repair <input type="checkbox"/> Replacement	N/A (Good Condition)
2	Covered Metal Storage Racks	<input checked="" type="checkbox"/> Yes <input type="checkbox"/> No	<input type="checkbox"/> Maintenance <input type="checkbox"/> Repair <input type="checkbox"/> Replacement	N/A (All metals covered)
3	Metal Recycle Bins (Covered)	<input checked="" type="checkbox"/> Yes <input type="checkbox"/> No	<input type="checkbox"/> Maintenance <input type="checkbox"/> Repair <input type="checkbox"/> Replacement	N/A (Covered)
4	Heavy Duty Tarps	<input checked="" type="checkbox"/> Yes <input type="checkbox"/> No	<input type="checkbox"/> Maintenance <input type="checkbox"/> Repair <input type="checkbox"/> Replacement	N/A (Good Condition)
5	Spill Control - Parking Areas	<input checked="" type="checkbox"/> Yes <input type="checkbox"/> No	<input type="checkbox"/> Maintenance <input type="checkbox"/> Repair <input type="checkbox"/> Replacement	No spills observed at the time of inspection or reported since previous inspection.

Areas of Industrial Materials or Activities exposed to stormwater

Below are some general areas that should be assessed during routine inspections. Customize this list as needed for the specific types of industrial materials or activities at your facility.

	Area/Activity	Inspected?	Controls Adequate (appropriate, effective, and operating)?	Corrective Action Needed and Notes
1	Material loading/unloading and storage areas	<input checked="" type="checkbox"/> Yes <input type="checkbox"/> No <input type="checkbox"/> N/A	<input checked="" type="checkbox"/> Yes <input type="checkbox"/> No	N/A
2	Equipment operations and maintenance areas	<input type="checkbox"/> Yes <input type="checkbox"/> No <input checked="" type="checkbox"/> N/A	<input type="checkbox"/> Yes <input type="checkbox"/> No	N/A
3	Fueling areas	<input type="checkbox"/> Yes <input type="checkbox"/> No <input checked="" type="checkbox"/> N/A	<input type="checkbox"/> Yes <input type="checkbox"/> No	N/A
4	Outdoor vehicle and equipment washing areas	<input type="checkbox"/> Yes <input type="checkbox"/> No <input checked="" type="checkbox"/> N/A	<input type="checkbox"/> Yes <input type="checkbox"/> No	N/A
5	Waste handling and disposal areas	<input type="checkbox"/> Yes <input type="checkbox"/> No <input checked="" type="checkbox"/> N/A	<input type="checkbox"/> Yes <input type="checkbox"/> No	N/A
6	Erodible areas/construction	<input type="checkbox"/> Yes <input type="checkbox"/> No <input checked="" type="checkbox"/> N/A	<input type="checkbox"/> Yes <input type="checkbox"/> No	N/A
7	Non-stormwater/ illicit connections	<input type="checkbox"/> Yes <input type="checkbox"/> No <input checked="" type="checkbox"/> N/A	<input type="checkbox"/> Yes <input type="checkbox"/> No	N/A
8	Salt storage piles or pile containing salt	<input type="checkbox"/> Yes <input type="checkbox"/> No <input checked="" type="checkbox"/> N/A	<input type="checkbox"/> Yes <input type="checkbox"/> No	N/A
9	Dust generation and vehicle tracking	<input type="checkbox"/> Yes <input type="checkbox"/> No <input checked="" type="checkbox"/> N/A	<input type="checkbox"/> Yes <input type="checkbox"/> No	N/A
10	(Other)	<input type="checkbox"/> Yes <input type="checkbox"/> No <input type="checkbox"/> N/A	<input type="checkbox"/> Yes <input type="checkbox"/> No	
11	(Other)	<input type="checkbox"/> Yes <input type="checkbox"/> No <input type="checkbox"/> N/A	<input type="checkbox"/> Yes <input type="checkbox"/> No	
12	(Other)	<input type="checkbox"/> Yes <input type="checkbox"/> No <input type="checkbox"/> N/A	<input type="checkbox"/> Yes <input type="checkbox"/> No	

Non-Compliance

Describe any incidents of non-compliance observed and not described above:

The yard was clean and in good condition. There were no incidents of non-compliance observed.

The stormwater with an oily sheen that was in the trench drain sump (west of the pipefitter's shop), was pumped out on 10/23/15. FSR (#144268) has been placed to clean the sludge out of the sump and a Petro Plug has been installed on the outlet pipe to prevent oil from being discharged into the upper parking lot when draining of the sump needs to be performed.

Additional Control Measures

Describe any additional control measures needed to comply with the permit requirements:

The sludge in the trench drain sump needs to be removed.

Notes

Use this space for any additional notes or observations from the inspection:

N/A

CERTIFICATION STATEMENT

"I certify under penalty of law that this document and all attachments were prepared under my direction or supervision in accordance with a system designed to assure that qualified personnel properly gathered and evaluated the information submitted. Based on my inquiry of the person or persons who manage the system, or those persons directly responsible for gathering the information, the information submitted is, to the best of my knowledge and belief, true, accurate, and complete. I am aware that there are significant penalties for submitting false information, including the possibility of fine and imprisonment for knowing violations."

Print name and title: Phil Romero, ESH Manager

Signature: _____

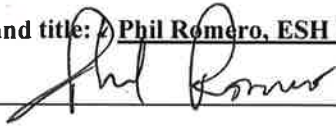

Date: _____

11/23/15

Burgin, Jillian E

From: FSR <ops-fp-fmu@lanl.gov>
Sent: Wednesday, October 28, 2015 12:53 PM
To: Burgin, Jillian E
Subject: 030038 storm drain clean out - ENV non-compliance ISSUE=144268 PROJ=13

When replying, type your text above this line.

Notification of Issue Change

The following changes have been made to this Issue: *Changed Status to Open from Request, Changed Priority to Urgent from Routine, Changed Title, Changed BLDG- to Roads/Grounds/Parking Lots from 0038 ,Set FOD to UI - FOD 8 ,Set Roads & Grounds BLDG: to 0038 ,Set PCB Evaluation to No ,Set Design Modification Required? to No ,Set Authorization Basis Change Required? to No ,Set Discipline to Laborer; , Added Assignee : Michael F. Martinez Phillip E. Ulibarri.*

Workspace: Facility Service Request (FSR)

Issue: 030038 storm drain clean out - ENV non-compliance

Issue Number:144268

Priority: Urgent **Status:** Open
Date: 10/28/2015 **Time:** 12:52:16
Creation Date:10/28/2015 **Creation Time:**10:38:44
Created By: 117365

Description:

Entered on 10/28/2015 at 12:47:11 PM MDT (GMT-0600) by rdstone@lanl.gov:

DSESH-UI cost codes will purchase containers for this specific work evolution. The traffic engineer has stated that the storm drain will be put on a PM that will start next spring and containers will be purchased as necessary as part of that PM package.

Russell Stone, CSP
ESH Manager (acting)
Utilities and Infrastructure
Office 606-0071
Cell 500-6244
Schedule A

Entered on 10/28/2015 at 12:18:43 PM MDT (GMT-0600) by algarcia@lanl.gov:

Cost string will be needed to purchase containers.

Entered on 10/28/2015 at 10:38:44 AM MDT (GMT-0600) by 117365:

The storm drain just outside the plumbers fabrication shop (northwest corner, bottom of the ramp) has a layer of oily sludge in the bottom. The sludge must be removed and containerized. Please contact Audrey Garcia (665-4914) for containers. This is an environmental non-compliance and must be completed by 11/5/2015.

Current Assignees: Allen J. Romero, Anthony R. Casados, Evan Schmidt, James Rabold, Michael F. Martinez, David Olivas, Phillip E. Ulibarri, Bill Schleft

Issue Information:

Services: Maintenance **Requesting Group:** DSESH-UI
TA-: 03 **BLDG-:** Roads/Grounds/Parking
Roads & Grounds BLDG:: 0038 **BAS Service:** Lots
Room-: outside **Unreviewed Safety Question (USQ)?:** BAS Craft
Cost Center:: 8V070A **Program Code::** XFM3
Cost Account:: 0502 **Work Package::** 0300
Requested Completion Date: 11/05/2015

Contact Information:

Z Number: 117365 **Name:** Russell Stone
Div-Group: DSESH-UI **Phone:** +1 505 606 0071
Pager: +1 505 664 1345 **E-mail:** rdstone@lanl.gov

Stormwater Industrial Routine Facility Inspection Report

General Information			
Facility Name	TA-3-38 Metals Fabrication Shop		
NPDES Tracking No.	NMR050000		
Date of Inspection	10/14/2015	Start/End Time	2:00-2:20 p.m.
Inspector's Name(s)	Jillian Burgin		
Inspector's Title(s)	DEP/CISEC		
Inspector's Contact Information	665-1893		
Inspector's Qualifications	CISEC (See SWPPP)		
Weather Information			
Weather at time of this inspection?			
<input checked="" type="checkbox"/> Clear <input type="checkbox"/> Cloudy <input type="checkbox"/> Rain <input type="checkbox"/> Sleet <input type="checkbox"/> Fog <input type="checkbox"/> Snow <input type="checkbox"/> High Winds <input type="checkbox"/> Other: Temperature: 74° F			
Have any previously unidentified discharges of pollutants occurred since the last inspection? <input type="checkbox"/> Yes <input checked="" type="checkbox"/> No If yes, describe: N/A			
Are there any discharges occurring at the time of inspection? <input type="checkbox"/> Yes <input checked="" type="checkbox"/> No If yes, describe: N/A			

Control Measures

- Number the structural stormwater control measures identified in your SWPPP on your site map and list them below (add as many control measures as are implemented on-site). Carry a copy of the numbered site map with you during your inspections. This list will ensure that you are inspecting all required control measures at your facility.
- Describe corrective actions initiated, date completed, and note the person that completed the work in the Corrective Action Log.

	Structural Control Measure	Control Measure is Operating Effectively?	If No, In Need of Maintenance, Repair, or Replacement?	Corrective Action Needed and Notes (identify needed maintenance and repairs, or any failed control measures that need replacement)
1	Asphalt berming	<input checked="" type="checkbox"/> Yes <input type="checkbox"/> No	<input type="checkbox"/> Maintenance <input type="checkbox"/> Repair <input type="checkbox"/> Replacement	N/A
2	Covered Metal Storage Racks	<input checked="" type="checkbox"/> Yes <input type="checkbox"/> No	<input type="checkbox"/> Maintenance <input type="checkbox"/> Repair <input type="checkbox"/> Replacement	N/A
3	Metal Recycle Bins (Covered)	<input checked="" type="checkbox"/> Yes <input type="checkbox"/> No	<input type="checkbox"/> Maintenance <input type="checkbox"/> Repair <input type="checkbox"/> Replacement	The small blue roll-off bin for metal shavings was removed. The larger covered bin was not on site.
4	Tarps	<input checked="" type="checkbox"/> Yes <input type="checkbox"/> No	<input type="checkbox"/> Maintenance <input type="checkbox"/> Repair <input type="checkbox"/> Replacement	N/A
5	Spill Control - Parking Areas	<input checked="" type="checkbox"/> Yes <input type="checkbox"/> No	<input type="checkbox"/> Maintenance <input type="checkbox"/> Repair <input type="checkbox"/> Replacement	Spill reported east of metal storage yard. See non-compliance section.

Areas of Industrial Materials or Activities exposed to stormwater

Below are some general areas that should be assessed during routine inspections. Customize this list as needed for the specific types of industrial materials or activities at your facility.

	Area/Activity	Inspected?	Controls Adequate (appropriate, effective, and operating)?	Corrective Action Needed and Notes
1	Material loading/unloading and storage areas	<input checked="" type="checkbox"/> Yes <input type="checkbox"/> No <input type="checkbox"/> N/A	<input checked="" type="checkbox"/> Yes <input type="checkbox"/> No	N/A
2	Equipment operations and maintenance areas	<input type="checkbox"/> Yes <input type="checkbox"/> No <input checked="" type="checkbox"/> N/A	<input type="checkbox"/> Yes <input type="checkbox"/> No	N/A
3	Fueling areas	<input type="checkbox"/> Yes <input type="checkbox"/> No <input checked="" type="checkbox"/> N/A	<input type="checkbox"/> Yes <input type="checkbox"/> No	N/A
4	Outdoor vehicle and equipment washing areas	<input type="checkbox"/> Yes <input type="checkbox"/> No <input checked="" type="checkbox"/> N/A	<input type="checkbox"/> Yes <input type="checkbox"/> No	N/A
5	Waste handling and disposal areas	<input type="checkbox"/> Yes <input type="checkbox"/> No <input checked="" type="checkbox"/> N/A	<input type="checkbox"/> Yes <input type="checkbox"/> No	N/A
6	Erodible areas/construction	<input type="checkbox"/> Yes <input type="checkbox"/> No <input checked="" type="checkbox"/> N/A	<input type="checkbox"/> Yes <input type="checkbox"/> No	N/A
7	Non-stormwater/ illicit connections	<input type="checkbox"/> Yes <input type="checkbox"/> No <input checked="" type="checkbox"/> N/A	<input type="checkbox"/> Yes <input type="checkbox"/> No	N/A
8	Salt storage piles or pile containing salt	<input type="checkbox"/> Yes <input type="checkbox"/> No <input checked="" type="checkbox"/> N/A	<input type="checkbox"/> Yes <input type="checkbox"/> No	N/A
9	Dust generation and vehicle tracking	<input type="checkbox"/> Yes <input type="checkbox"/> No <input checked="" type="checkbox"/> N/A	<input type="checkbox"/> Yes <input type="checkbox"/> No	N/A
10	(Other)	<input type="checkbox"/> Yes <input type="checkbox"/> No <input type="checkbox"/> N/A	<input type="checkbox"/> Yes <input type="checkbox"/> No	
11	(Other)	<input type="checkbox"/> Yes <input type="checkbox"/> No <input type="checkbox"/> N/A	<input type="checkbox"/> Yes <input type="checkbox"/> No	
12	(Other)	<input type="checkbox"/> Yes <input type="checkbox"/> No <input type="checkbox"/> N/A	<input type="checkbox"/> Yes <input type="checkbox"/> No	

Non-Compliance

Describe any incidents of non-compliance observed and not described above:

Powdered material from an inadvertent fire extinguisher discharge was noticed on the asphalt parking lot east of the outdoor Metals Fab storage yard. EM&R was immediately notified and the material was cleaned-up. A spill report was completed and will be added to the SWPPP.

The trench drain (west of the pipefitter's shop) stormwater contained an oil sheen during the previous inspection/permit (9/8/15). Absorbent oil pads and booms were placed into the trench drain on 9/9/15. The stormwater in the trench drain will be pumped out under FSR# 136108 as soon as it can be scheduled.

Additional Control Measures

Describe any additional control measures needed to comply with the permit requirements:

None at this time, all previous corrective actions have been corrected.

Notes

Use this space for any additional notes or observations from the inspection:

Permit coverage under the 2015 MSGP began on October 3, 2015.

CERTIFICATION STATEMENT

"I certify under penalty of law that this document and all attachments were prepared under my direction or supervision in accordance with a system designed to assure that qualified personnel properly gathered and evaluated the information submitted. Based on my inquiry of the person or persons who manage the system, or those persons directly responsible for gathering the information, the information submitted is, to the best of my knowledge and belief, true, accurate, and complete. I am aware that there are significant penalties for submitting false information, including the possibility of fine and imprisonment for knowing violations."

Print name and title: Phil Romero, ESH Manager

Signature: *Phil Romero* Date: 10-15-15

	Structural Control Measure	Control Measure is Operating Effectively?	If No, In Need of Maintenance, Repair, or Replacement?	Corrective Action Needed and Notes (identify needed maintenance and repairs, or any failed control measures that need replacement)
	Name		<input type="checkbox"/> Replacement	
8	Insert Control Measure Name	<input type="checkbox"/> Yes <input type="checkbox"/> No	<input type="checkbox"/> Maintenance <input type="checkbox"/> Repair <input type="checkbox"/> Replacement	Describe Corrective Actions
9	Insert Control Measure Name	<input type="checkbox"/> Yes <input type="checkbox"/> No	<input type="checkbox"/> Maintenance <input type="checkbox"/> Repair <input type="checkbox"/> Replacement	Describe Corrective Actions
10	Insert Control Measure Name	<input type="checkbox"/> Yes <input type="checkbox"/> No	<input type="checkbox"/> Maintenance <input type="checkbox"/> Repair <input type="checkbox"/> Replacement	Describe Corrective Actions

Areas of Industrial Materials or Activities exposed to stormwater

Below are some general areas that should be assessed during routine inspections. Customize this list as needed for the specific types of industrial materials or activities at your facility.

	Area/Activity	Inspected?	Controls Adequate (appropriate, effective, and operating)?	Corrective Action Needed and Notes
1	Material loading/unloading and storage areas	<input type="checkbox"/> Yes <input type="checkbox"/> No <input type="checkbox"/> N/A	<input type="checkbox"/> Yes <input type="checkbox"/> No	Describe Corrective Actions
2	Equipment operations and maintenance areas	<input type="checkbox"/> Yes <input type="checkbox"/> No <input type="checkbox"/> N/A	<input type="checkbox"/> Yes <input type="checkbox"/> No	Describe Corrective Actions
3	Fueling areas	<input type="checkbox"/> Yes <input type="checkbox"/> No <input type="checkbox"/> N/A	<input type="checkbox"/> Yes <input type="checkbox"/> No	Describe Corrective Actions
4	Outdoor vehicle and equipment washing areas	<input type="checkbox"/> Yes <input type="checkbox"/> No <input type="checkbox"/> N/A	<input type="checkbox"/> Yes <input type="checkbox"/> No	Describe Corrective Actions
5	Waste handling and disposal areas	<input type="checkbox"/> Yes <input type="checkbox"/> No <input type="checkbox"/> N/A	<input type="checkbox"/> Yes <input type="checkbox"/> No	Describe Corrective Actions
6	Erodible areas/construction	<input type="checkbox"/> Yes <input type="checkbox"/> No <input type="checkbox"/> N/A	<input type="checkbox"/> Yes <input type="checkbox"/> No	Describe Corrective Actions
7	Non-stormwater/ illicit connections	<input type="checkbox"/> Yes <input type="checkbox"/> No <input type="checkbox"/> N/A	<input type="checkbox"/> Yes <input type="checkbox"/> No	Describe Corrective Actions
8	Salt storage piles or pile containing salt	<input type="checkbox"/> Yes <input type="checkbox"/> No <input type="checkbox"/> N/A	<input type="checkbox"/> Yes <input type="checkbox"/> No	Describe Corrective Actions
9	Dust generation and vehicle tracking	<input type="checkbox"/> Yes <input type="checkbox"/> No <input type="checkbox"/> N/A	<input type="checkbox"/> Yes <input type="checkbox"/> No	Describe Corrective Actions
10	(Other)	<input type="checkbox"/> Yes <input type="checkbox"/> No <input type="checkbox"/> N/A	<input type="checkbox"/> Yes <input type="checkbox"/> No	Describe Corrective Actions
11	(Other)	<input type="checkbox"/> Yes <input type="checkbox"/> No <input type="checkbox"/> N/A	<input type="checkbox"/> Yes <input type="checkbox"/> No	Describe Corrective Actions

	Area/Activity	Inspected?	Controls Adequate (appropriate, effective, and operating)?	Corrective Action Needed and Notes
12	(Other)	<input type="checkbox"/> Yes <input type="checkbox"/> No <input type="checkbox"/> N/A	<input type="checkbox"/> Yes <input type="checkbox"/> No	Describe Corrective Actions

Non-Compliance

Describe any incidents of non-compliance observed and not described above:

Describe Non-compliance

Additional Control Measures

Describe any additional control measures needed to comply with the permit requirements:

Describe Additional Controls Needed

Notes

Use this space for any additional notes or observations from the inspection:

Additional Notes

CERTIFICATION STATEMENT

“I certify under penalty of law that this document and all attachments were prepared under my direction or supervision in accordance with a system designed to assure that qualified personnel properly gathered and evaluated the information submitted. Based on my inquiry of the person or persons who manage the system, or those persons directly responsible for gathering the information, the information submitted is, to the best of my knowledge and belief, true, accurate, and complete. I am aware that there are significant penalties for submitting false information, including the possibility of fine and imprisonment for knowing violations.”

Print name and title: _____

Signature: _____ **Date:** _____

MSGP Quarterly Visual Assessment Form

Complete a separate form for each outfall you assess. When adverse weather conditions prevent the collection of a sample during the quarter, a substitute sample must be taken during the next qualifying storm event. Maintain this document in your SWPPP.

Name/Location of Facility:		Permit Number: NMR05GB21	Inspection Quarter: <input type="checkbox"/> Apr-May <input type="checkbox"/> Jun-July <input type="checkbox"/> Aug-Sep <input type="checkbox"/> Oct-Nov
Outfall ID:	"Substantially Identical Outfall"? <input type="checkbox"/> Yes <input type="checkbox"/> No	If YES identify other Outfalls in the Group:	
Person(s) collecting sample (PRINT): PPT Member? <input type="checkbox"/> Yes <input type="checkbox"/> No		Signature:	
Person(s) examining sample (PRINT): PPT Member? <input type="checkbox"/> Yes <input type="checkbox"/> No		Signature:	
Date & Time Discharge Began:	Date & Time Sample Collected:	Date & Time Sample Examined:	
Substitute Sample? <input type="checkbox"/> Yes <input type="checkbox"/> No		If YES, identify quarter/year when sample was originally scheduled to be collected:	
Was the sample collected in the first 30 minutes? <input type="checkbox"/> Yes <input type="checkbox"/> No If No, explain why not:			
Nature of Discharge: <input type="checkbox"/> Rainfall. Amount _____ inches <input type="checkbox"/> Snowmelt. Amount _____ inches			
Previous Storm Ended > 72 hours Before Start of This Storm? <input type="checkbox"/> Yes <input type="checkbox"/> No			If No, Explain: *
PARAMETERS			
Color	<input type="checkbox"/> None <input type="checkbox"/> Other		If Other describe:
Odor	<input type="checkbox"/> None <input type="checkbox"/> Musty <input type="checkbox"/> Sewage <input type="checkbox"/> Sulfur <input type="checkbox"/> Sour <input type="checkbox"/> Solvents <input type="checkbox"/> Petroleum/Gas <input type="checkbox"/> Other		If Other, describe the odor:
Clarity:	<input type="checkbox"/> Clear <input type="checkbox"/> Slightly Cloudy <input type="checkbox"/> Cloudy <input type="checkbox"/> Opaque <input type="checkbox"/> Other (describe):		
Floating Solids:	<input type="checkbox"/> Yes <input type="checkbox"/> No	If YES, describe if raw or waste materials(s):	
Settled Solids:**	<input type="checkbox"/> Yes <input type="checkbox"/> No	If YES, are solids Fine <input type="checkbox"/> Coarse <input type="checkbox"/> If Other describe:	
Suspended Solids:	<input type="checkbox"/> Yes <input type="checkbox"/> No	If YES, are solids Fine <input type="checkbox"/> Coarse <input type="checkbox"/> If Other describe:	
Foam (gently shake sample):	<input type="checkbox"/> Yes <input type="checkbox"/> No	If YES, on the surface <input type="checkbox"/> or <input type="checkbox"/> in the water. Describe color:	
Oil Sheen <input type="checkbox"/> Yes <input type="checkbox"/> No Color of Sheen:	Thickness: Flecks <input type="checkbox"/> Globbs <input type="checkbox"/> Describe if other:		
Other Obvious Indicators of Pollution Present in the sample? Yes <input type="checkbox"/> No <input type="checkbox"/>	If YES describe:		
SITE OBSERVATIONS			
Potential pollutants found during visual examination? <input type="checkbox"/> Yes <input type="checkbox"/> No If Yes, list pollutant(s) and if possible indicate the source: If source is identified during collection of sample, please notify Holly Wheeler @ 667-1312			
Pollutant	Source	Pollutant	Source
NOTE: A clean up of the site should be conducted if the pollutant source is known. Was proper Notification made? <input type="checkbox"/> Yes <input type="checkbox"/> No If Yes, indicate who was notified:			
CORRECTIVE ACTION			
If storm water contamination was identified in this sample through visual assessment, was a Corrective Action Form filled out within 24 hrs of observation? Yes <input type="checkbox"/> No <input type="checkbox"/> If No, explain why not:			
Was a Corrective Action Plan identified within 14 days of the observation? Yes <input type="checkbox"/> No <input type="checkbox"/> If No, explain why not:			
Other Relevant Information: Yes <input type="checkbox"/> No <input type="checkbox"/> Use the back of this form to list any concerns, comments, and/or descriptions of pictures taken, (attach additional sheets as necessary).			
* The 72-hour interval can be waived when the previous storm did not yield a measurable discharge or if you are able to document (attach applicable documentation) that less than a 72-hour interval is representative of local storm events during the sampling period.			
** Observe for settled solids after allowing the sample to sit for approximately one-half hour.			

APPENDIX G

Spill Tracking Table

Table for Tracking Past and Future Spills

Date	Spill Location	What Spilled	Quantity Spilled	Corrective Action Taken	Plans to Prevent Recurrence
05/07	TA-3-38 parking lot, NM corner at roofing project staging area	engine oil from forklift	Aprox. 1 pt to 1 qt.	LANS Contractor ES&H reported the spill. Oily water was absorbed, oily spots cleaned up, waste generated removed and disposed of properly	Contractor removed the leaking piece of equipment from the site.
09/07	TA-3-38 Parking lot Northwest side of Bldg/lot	Roofing Tar	~5 gallons	LANs Contractor ES&H reported the spill. Personnel placed a pig mat around nearby drain.	Contractor removed materials from parking lot.
04/08	Compressor and piping located West of pipe fitters shop	Compressor oil	~5 gallons	Sampled (contains 3 ppm of PCB)? cleanup	Spill pans placed under compressor and associated piping
	TA-3-38 Upper W. Parking Lot	Diesel	~5 gallons	Called EM&R Cleaned Up & Moved Equipment	Discussed with HEY
	TA3-38 Lower W. Parking Lot	Oil	1 Quart	Cleaned and put into N.M. Special Waste Area	
09/15 (15a)	3-38 Metal Storage Yard (leak from metal roll-off bin while being removed)	Cutting oil/water	~1 gal	EM&R Responded and remediated	Roll-off bin has been removed from facility.
10/15 (15b)	3-38 West Yard (east of metal storage area)	Powder from Fire Extinguisher	~8 oz	EM&R Responded and remediated	FP Manager contacted.
10/15 (15c)	North west side of 3-38	Water with oil sheen pumped out of trench drain	~10-20 gals	DEP sprayed area with Microblaze	Petro plug was installed at end pipe to catch oil from any future discharges. TD Sump was eventually cleaned out.

APPENDIX G-1
Spill Report Template & Complete Forms

**Los Alamos National Laboratory
Environmental Compliance Programs (ENV-CP)
Unplanned Release Report**

Form Completed By: Jillian Burgin		Telephone: 5-1893	Group: DSESH-ADPM
Spill Details		Spill Owner (Specify): <input checked="" type="checkbox"/> LANS, LLC	<input type="checkbox"/> Subcontractor:
Date of Spill/Date Spill Discovered: 10/22/15			
Location: TA-3-38 Metals Fab - N of Bldg.			
Material Spilled:		<input type="checkbox"/> Anti-freeze/coolant <input type="checkbox"/> Gasoline <input type="checkbox"/> Steam Condensate <input checked="" type="checkbox"/> Other: <u>Water with oil sheen</u> <input type="checkbox"/> Potable Water <input type="checkbox"/> Lubricants/oils <input type="checkbox"/> Diesel <input type="checkbox"/> Refrigerant Oil	
Volume Spilled: Unknown (estimate is 10-20 gals)		Waste Volume Generated: n/a	
Source of Spill: Stormwater Trench Drain		<input type="checkbox"/> Hydraulic Line <input type="checkbox"/> Radiator <input type="checkbox"/> Potable Water Line <input type="checkbox"/> Condensate Line <input type="checkbox"/> Fire Suppression System <input type="checkbox"/> Other: _____ <input type="checkbox"/> Fuel Tank	
Vehicle ID: _____		Equipment ID: _____	
Describe the spill response in chronological order. Include response personnel, steps taken to contain the spill, and steps/spill control equipment used to clean it up. Please indicate if corrective actions have been completed and describe actions taken to prevent spill recurrence: The trench drain associated with the TA-3-38 Metals Fab and Pipefitter's shop was being prepared to be pumped out due to oil sheen present in the stormwater. However, heavy rains occurred on Oct. 21 which began flooding of the drain outside of the Pipefitter's shop. It is unknown as to when the water was pumped out. The pump comes on automatically when the drain begins to overflow and pumps water to the north and east above the shops. The pump was supposed to be unplugged (pending installation of GFCI for the electrical outlet) however it was plugged in and pumped the water with oil sheen out. On the morning of Oct. 22 it was noticed that some of the water had been pumped out to relieve flooding. The area north and east of the shop (where the water discharges) was evaluated and Microblaze was sprayed to the area to absorb any remaining residual oil discharged with the stormwater. The remaining accumulated stormwater was pumped out of the trench drain on 10/23. A petro-plug was installed at the end of the pipe (discharge point) to prevent further release of oil. A PM will be created to clean-out the oily sludge that is present in the storm drain.			
Date Corrective Actions Completed: <u>10/23/2015</u>			
Did the spill enter or impact any of the following? (Check as many as apply)		<input type="checkbox"/> Floor Drain, if so please indicate affected facility _____ <input type="checkbox"/> Watercourse/drainage area, if so please indicate _____ <input type="checkbox"/> Solid Waste Management Unit/Area of Concern, if so please indicate _____ <input checked="" type="checkbox"/> None	
<input type="checkbox"/> RCRA Treatment Storage Disposal Facility		<input type="checkbox"/> RCRA Satellite Accumulation Area	
<input type="checkbox"/> RCRA <90 Day Storage Area			
Did the spill occur inside or outside a building?		<input type="checkbox"/> Inside <input checked="" type="checkbox"/> Outside	
Did the spill occur on: (Check as many as apply)		<input type="checkbox"/> Concrete <input checked="" type="checkbox"/> Asphalt <input type="checkbox"/> Carpeted Floor <input type="checkbox"/> Graveled/Rocky Area <input type="checkbox"/> Tile <input type="checkbox"/> Soil/Vegetated Area <input type="checkbox"/> Wooden floor/deck <input type="checkbox"/> Other: _____	
Samples Collected:		If samples were collected, indicate analytical suite:	
<input checked="" type="checkbox"/> None <input type="checkbox"/> Soil <input type="checkbox"/> Water <input type="checkbox"/> Air <input type="checkbox"/> Other: _____			
Certification			
I certify that I am knowledgeable about the information on this form. The information, to my knowledge, is true, accurate, and complete.			
Name of Certifying Official: Jillian E. Burgin		Organization: DSESH-ADPM	Date: 10/27/15
Certification: Jillian Burgin <small>Digital signed by Jillian Burgin DN: cn=Jillian Burgin, ou=Environmental Compliance Programs, o=LANL, email=jburgin@lanl.gov, c=US Date: 2015.10.27 14:36:24 -0800</small>			
Completed by ENV-CP Personnel		<input type="checkbox"/> Non-Reportable	
Date Received:	Severity Index:	Causal Analysis:	<input type="checkbox"/> Reportable

**Los Alamos National Laboratory
Environmental Compliance Programs (ENV-CP)
Unplanned Release Report**

Form Completed By: Jillian Burgin **Telephone:** 5-1893 **Group:** DSESH-ADPM

Spill Details: Spill Owner (Specify): LANS, LLC Subcontractor:

Date of Spill/Date Spill Discovered: 10/14/15

Location: TA-3-38 Metals Fab - West Yard (East of Metal Storage Area)

Material Spilled:

<input type="checkbox"/> Hydraulic Fluid	<input type="checkbox"/> Anti-freeze/coolant	<input type="checkbox"/> Gasoline
<input type="checkbox"/> Potable Water	<input type="checkbox"/> Steam Condensate	<input checked="" type="checkbox"/> Other: Powder from Fire Extinguisher
<input type="checkbox"/> Diesel	<input type="checkbox"/> Lubricants/oils	
	<input type="checkbox"/> Refrigerant Oil	

Volume Spilled: ~8 ounces **Waste Volume Generated:** 1/2 bag of sanitary trash

Source of Spill: Fire Extinguisher Discharge Hydraulic Line Radiator
Vehicle ID: _____ Potable Water Line Condensate Line
Equipment ID: _____ Fire Suppression System Other: _____
 Fuel Tank

Describe the spill response in chronological order. Include response personnel, steps taken to contain the spill, and steps/spill control equipment used to clean it up. Please indicate if corrective actions have been completed and describe actions taken to prevent spill recurrence:

At approximately 2:00 p.m., a stormwater inspection was being performed when the spilled material was discovered east of the fenced, outdoor metal storage yard on the asphalt parking lot. The material was a non-hazardous powder (consisting primarily of ammonium sulfate) from an inadvertently discharged fire extinguisher. The Metals Fab Shop Superintendent and DEP performing the inspection called EM&R for spill response. The spill was remediated by vacuuming followed by light water and broom sweep up. It is unknown as to the cause of the event. It is suspected that the fire extinguisher may have fell off of a work truck and discharged. The material had been left spilled at the site and no one was present who knew what had happened. The WMCs and fire protection supervisor on the scene evaluated the used fire extinguishers stored in area but did not find anything conclusive. The LOG-MSS DEP will send out a notification of the event in the weekly division newsletter in an effort to prevent recurrence. The material did not enter a storm drain or any outfalls at the facility.

Date Corrective Actions Completed: 10/14/15

Did the spill enter or impact any of the following? (Check as many as apply)

<input type="checkbox"/> RCRA Treatment Storage Disposal Facility	<input type="checkbox"/> Floor Drain, if so please indicate affected facility
<input type="checkbox"/> RCRA Satellite Accumulation Area	<input type="checkbox"/> Watercourse/drainage area, if so please indicate
<input type="checkbox"/> RCRA <90 Day Storage Area	<input type="checkbox"/> Solid Waste Management Unit/Area of Concern, if so please indicate
	<input checked="" type="checkbox"/> None

MSGP Site (Metals Fab Shop)

Did the spill occur inside or outside a building? Inside Outside

Did the spill occur on: (Check as many as apply)

<input type="checkbox"/> Concrete	<input checked="" type="checkbox"/> Asphalt
<input type="checkbox"/> Carpeted Floor	<input type="checkbox"/> Graveled/Rocky Area
<input type="checkbox"/> Tile	<input type="checkbox"/> Soil/Vegetated Area
<input type="checkbox"/> Wooden floor/deck	<input type="checkbox"/> Other: _____

Samples Collected: Soil If samples were collected, indicate analytical suite:
 None Air
 Water Other: _____

Certification
I certify that I am knowledgeable about the information on this form. The information, to my knowledge, is true, accurate, and complete.

Name of Certifying Official: Jillian E. Burgin **Organization:** DSESH-ADPM **Date:** 10/14/15

Certification: Jillian Burgin
Digitally signed by Jillian Burgin
DN: cn=Jillian Burgin, o=Los Alamos National Laboratory, ou=DSESH-ADPM, email=jburgin@lanl.gov, c=US
Date: 2015.10.14 14:42:37 -0600

Completed by ENV-CP Personnel Non-Reportable
Date Received: **Severity Index:** **Causal Analysis:** Reportable

**Los Alamos National Laboratory
Environmental Compliance Programs (ENV-CP)
Unplanned Release Report**

Form Completed By:		Telephone:		Group:	
Jillian Burgin		5-1893		DSESH-ADPM	
Spill Details		Spill Owner (Specify): <input checked="" type="checkbox"/> LANS, LLC		<input type="checkbox"/> Subcontractor:	
Date of Spill/Date Spill Discovered: 9/9/15					
Location: TA-38 Metals Fab - Metals Storage Yard					
Material Spilled:		<input type="checkbox"/> Anti-freeze/coolant		<input type="checkbox"/> Gasoline	
<input type="checkbox"/> Hydraulic Fluid		<input type="checkbox"/> Steam Condensate		<input checked="" type="checkbox"/> Other: Water	
<input type="checkbox"/> Potable Water		<input checked="" type="checkbox"/> Lubricants/oils			
<input type="checkbox"/> Diesel		<input type="checkbox"/> Refrigerant Oil			
Volume Spilled: ~1gal water w/small amt of cutting oil. Waste Volume Generated: n/a					
Source of Spill: Metal shavings recycle being moved to MRF.		<input type="checkbox"/> Hydraulic Line		<input type="checkbox"/> Radiator	
Vehicle ID: _____		<input type="checkbox"/> Potable Water Line		<input type="checkbox"/> Condensate Line	
Equipment ID: _____		<input type="checkbox"/> Fire Suppression System		<input type="checkbox"/> Other: _____	
<input type="checkbox"/> Fuel Tank					
Describe the spill response in chronological order. Include response personnel, steps taken to contain the spill, and steps/spill control equipment used to clean it up. Please indicate if corrective actions have been completed and describe actions taken to prevent spill recurrence:					
<p>At approximately 11:00 a.m., a MRF driver was removing the 15-yard metal shaving recycle bin (with an old torn cover) from the Metals Fab yard to replace the bin with one equipped with a new cover (as per corrective actions/SWPPP requirements). When the bin was being moved, a small amount of water containing residual amounts of cutting oil (Coolube 2210EP) leaked out onto the asphalt. A WMC was called and EM&R also responded to the scene. The spill was remediated with Microblaze along with an adjacent area on the asphalt where the fluid had previously leached out of the bin via stormwater. The spilled material did not leave the site. The Metals Fab Superintendent requested the bin be totally removed from the yard (and not replaced), since the pipefitters had been using the bin and not the Metals Fab shop. The bin was not ultimately not replaced and is no longer on site.</p>					
Date Corrective Actions Completed: 9/9/15					
Did the spill enter or impact any of the following? (Check as many as apply)		<input type="checkbox"/> Floor Drain, if so please indicate affected facility			
<input type="checkbox"/> RCRA Treatment Storage Disposal Facility		<input type="checkbox"/> Watercourse/drainage area, if so please indicate			
<input type="checkbox"/> RCRA Satellite Accumulation Area		<input type="checkbox"/> Solid Waste Management Unit/Area of Concern, if so please indicate			
<input type="checkbox"/> RCRA <90 Day Storage Area		<input type="checkbox"/> MSGP Site (Metals Fab Shop)			
		<input checked="" type="checkbox"/> None			
Did the spill occur inside or outside a building?		<input type="checkbox"/> Inside		<input checked="" type="checkbox"/> Outside	
Did the spill occur on:		<input type="checkbox"/> Concrete		<input checked="" type="checkbox"/> Asphalt	
(Check as many as apply)		<input type="checkbox"/> Carpeted Floor		<input type="checkbox"/> Graveled/Rocky Area	
		<input type="checkbox"/> Tile		<input type="checkbox"/> Soil/Vegetated Area	
		<input type="checkbox"/> Wooden floor/deck		<input type="checkbox"/> Other: _____	
Samples Collected:		<input type="checkbox"/> Soil		If samples were collected, indicate analytical suite:	
<input checked="" type="checkbox"/> None		<input type="checkbox"/> Air			
<input type="checkbox"/> Water		Other: _____			
Certification					
I certify that I am knowledgeable about the information on this form. The information, to my knowledge, is true, accurate, and complete.					
Name of Certifying Official: Jillian E. Burgin		Organization: DSESH-ADPM		Date: 9/10/15	
Certification: Jillian Burgin		<small>Digitally signed by Jillian E. Burgin DN: cn=Jillian Burgin, o=Los Alamos National Laboratory, ou=DSESH-ADPM, email=jburgin@lanl.gov, c=US Date: 2015.09.10 14:42:57 -0600</small>			
Completed by ENV-CP Personnel		<input type="checkbox"/> Non-Reportable		<input type="checkbox"/> Reportable	
Date Received:		Severity Index:		Causal Analysis:	

**Los Alamos National Laboratory
Environmental Compliance Programs (ENV-CP)
Unplanned Release Report**

Form Completed By:	Telephone:	Group:
---------------------------	-------------------	---------------

Spill Details	Spill Owner (Specify): <input type="checkbox"/> LANS, LLC	<input type="checkbox"/> Subcontractor:
----------------------	-----------------------------------------------------------	-----------------------------------------

Date of Spill/Date Spill Discovered:

Location:

Material Spilled:	<input type="checkbox"/> Anti-freeze/coolant	<input type="checkbox"/> Gasoline
<input type="checkbox"/> Hydraulic Fluid	<input type="checkbox"/> Steam Condensate	<input type="checkbox"/> Other: _____
<input type="checkbox"/> Potable Water	<input type="checkbox"/> Lubricants/oils	
<input type="checkbox"/> Diesel	<input type="checkbox"/> Refrigerant Oil	

Volume Spilled:	Waste Volume Generated:
------------------------	--------------------------------

Source of Spill:	<input type="checkbox"/> Hydraulic Line	<input type="checkbox"/> Radiator
Vehicle ID: _____	<input type="checkbox"/> Potable Water Line	<input type="checkbox"/> Condensate Line
Equipment ID: _____	<input type="checkbox"/> Fire Suppression System	<input type="checkbox"/> Other: _____
	<input type="checkbox"/> Fuel Tank	

Describe the spill response in chronological order. Include response personnel, steps taken to contain the spill, and steps/spill control equipment used to clean it up. Please indicate if corrective actions have been completed and describe actions taken to prevent spill recurrence:

Write Corrective Actions Completed: _____

Did the spill enter or impact any of the following? (Check as many as apply)	<input type="checkbox"/> Floor Drain, if so please indicate affected facility
<input type="checkbox"/> RCRA Treatment Storage Disposal Facility	<input type="checkbox"/> Watercourse/drainage area, if so please indicate
<input type="checkbox"/> RCRA Satellite Accumulation Area	<input type="checkbox"/> Solid Waste Management Unit/Area of Concern, if so please indicate
<input type="checkbox"/> RCRA <90 Day Storage Area	<input type="checkbox"/> None

Did the spill occur inside or outside a building?	<input type="checkbox"/> Inside	<input type="checkbox"/> Outside
----------------------------------------------------------	---------------------------------	----------------------------------

Did the spill occur on: (Check as many as apply)	<input type="checkbox"/> Concrete	<input type="checkbox"/> Asphalt
	<input type="checkbox"/> Carpeted Floor	<input type="checkbox"/> Graveled/Rocky Area
	<input type="checkbox"/> Tile	<input type="checkbox"/> Soil/Vegetated Area
	<input type="checkbox"/> Wooden floor/deck	<input type="checkbox"/> Other: _____

Samples Collected:	<input type="checkbox"/> Soil <input type="checkbox"/> Air <input type="checkbox"/> Other: _____	If samples were collected, indicate analytical suite:
<input type="checkbox"/> None		
<input type="checkbox"/> Water		

Certification

I certify that I am knowledgeable about the information on this form. The information, to my knowledge, is true, accurate, and complete.

Name of Certifying Official:	Organization:	Date:
Certification:		

<u>Completed by ENV-CP Personnel</u>	<input type="checkbox"/> Non-Reportable	
Date Received:	Severity Index:	Causal Analysis:
		<input type="checkbox"/> Reportable

APPENDIX H

Stormwater Monitoring Records and Results (Current Permit)

Permitted Facility: TA-3-38 Metals Fab Shop

Outfall: 002 (3-MFS-1)

Monitoring Requirement	Industrial Sector	Assessment Unit	Analyte	Filtered/ Unfiltered	Regulatory Standard	Units	Regulatory Standard Type	Regulatory Standard Reference
Impaired Waters	-	NM-9000.A_047	1336-36-3 (Total PCBs)	UF	0.00064	ug/L	NM 2010 HH Persistent	20.6.4.900 NMAC Subpart J
Impaired Waters/ Quarterly Benchmark	AA	NM-9000.A_047	Al	F10u ¹	681	ug/L	NM 2010 Aquatic Chronic 60 mg	20.6.4.900 NMAC Subpart I
Impaired Waters	-	NM-9000.A_047	Cu	F ²	6	ug/L	NM 2010 Aquatic Chronic 60 mg	20.6.4.900 NMAC Subpart I
Impaired Waters	-	NM-9000.A_047	Gross Alpha	UF	15	pCi/L	NM 2010 Livestock Watering	20.6.4.900 NMAC Subpart J
Impaired Waters	-	NM-9000.A_047	Tl	F	0.47	ug/L	NM 2010 HH Persistent	20.6.4.900 NMAC Subpart J
Quarterly Benchmark	AA	-	Fe	UF	1000	ug/L	MSGP QBM 2015	NMR053195 Sect 9.6.2.1
Quarterly Benchmark	AA	-	NO3+NO2-N	UF	0.68	mg/L	MSGP QBM 2015	NMR053195 Sect 9.6.2.1
Quarterly Benchmark	AA	-	Zn	F	76	ug/L	NM 2010 Aquatic Chronic 60 mg	20.6.4.900 NMAC Subpart I

¹F10u – 10 µm filter

²F – 0.45 µm filter

2015 MSGP Sampling and Analysis Plan

ANYL_METH_CODE	EPA:200.7 EPA:200.8 EPA 254.2	EPA:200.7 EPA:200.8 EPA 245.2	EPA:200.8	EPA:200.8	EPA:200.8	EPA:200.8	SM:2540D	EPA:335.4	EPA:410.4	EPA:350.1	EPA:608	EPA:1664A	EPA:900	FIELD												
ORDER CODE	MSGP Ag+As+Cd +Mg+Pb+Se+Hg	MSGP Al+Cu+Hg	MSGP-Tl	MSGP-Cu	MSGP-AI	MSGP-Zn	MSGP-TSS	MSGP-CN(TOTAL)	MSGP-COD	MSGP-NH3-N	MSGP-PCBs(Aroclor)	MSGP-Oil-Grease	MSGP-GrossA	pH	VA											
FIELD_PREP_CODE	UF	UF	F	UF	UF	UF	UF	UF	UF	UF	UF	UF	UF	UF	UF											
PRESERVATION	HNO3	HNO3	HNO3	HNO3	HNO3	HNO3	ICE	NAOH and ICE	H2SO4 & ICE	H2SO4 & ICE	ICE	HCL or H2SO4	HNO3													
HOLDING TIME	28	180	180	180	180	180	7	14	28	28	365	28	180	15 min												
PRIORITY	1	1	1	1	1	1	1	1	1	1	2	2	3													
VOLUME REQUIRED (L)	1	1	1	1	1	1	0.5	0.5	0.5	0.5	3	3	1	1												
SHIPPING CONTAINER	POLY	POLY	POLY	POLY	POLY	POLY	POLY	POLY	POLY	POLY	GLASS	GLASS	POLY	POLY												
Permitted Facility	Outfall	Station Number	Samples	Required Volume (L)												STD - POLY	STD - GLASS	REF - POLY	REF - GLASS	BOTTLE SET	Station Number	Samples				
TA-3-22 Power & Steam Plant	3-PSP-1	03-0022S	Annual																	1	1			1L G, 11 L Poly	03-0022S	1,2,3,4
	3-PSP-5	E121.9	Annual																	1	1			1L G, 11 L Poly	E121.9	1,2,3,4
	3-PSP-8	03-0022N	Annual																	1	1			1L G, 11 L Poly	03-0022N	1,2,3,4
TA-3-38 Metals Fab Shop	3-MFS-1	03-0038W	Annual							1										1	1	1		1L G, 11 L Poly	03-0038W	1,2,3,4
TA-3-39 & 102 Metal Shop	3-TS-1	03-0039E	1,2,3,4																	1	1			1L G, 11 L Poly	03-0039E	1,2,3,4
TA-3-66 Sigma Complex	3-SIGMA-6	E122.3	Annual																	1	1			1L G, 11 L Poly	E122.3	1,2,3,4
	3-SIGMA-8	03-0141E	Annual																	1	1			1L G, 11 L Poly	03-0141E	1,2,3,4
TA-60 Asphalt Batch Plant	60-ABP-1	E200.5	1*																	1	1		6.5	4 2 L Glass	E200.5	1,2,3,4
TA-60-1 Heavy Equipment Yard	60-HEY-2	60-0001	Annual																	1	1			1L G, 11 L Poly	60-0001	1,2,3,4
TA-60 MRF	60-MRF-1	E122.35	Annual																	1	1			1L G, 11 L Poly	E122.35	1
	60-MRF-1	E122.35	1,2,3,4								1									1	1			14 1L Poly	E122.35	1,2,3,4
TA-60 Roads and Grounds	60-RG-1	60-00RG	Annual																	1			3	4 2 L Glass	60-00RG	1,2,3,4
	60-RG-3	E123.4	Annual																	1	1			1L G, 11 L Poly	E123.4	1,2,3,4
	60-RG-8	60-00RGE	Annual																	1	1			1L G, 11 L Poly	60-00RGE	1,2,3,4
	60-RG-10	60-RGCFYE	Annual																	1	1			1L G, 11 L Poly	60-RGCFYE	1,2,3,4
	60-RG-13	60-RGCFYW	Annual																	1			4	4 2 L Glass	60-RGCFYW	1,2,3,4
	60-RG-13	60-RGCFYW	Annual																		1	2		1L G, 11 L Poly	60-RGCFYW	1
TA-60-2 Warehouse	60-WH-1	60-0002E	Annual																	1	1			1L G, 11 L Poly	60-0002E	1,2,3,4
TA-54 Area G	54-G-1	E248	1,2,3,4																	1	1			14 1L Poly	E248	1,2,3,4
	54-G-2	E227	1,2,3,4																	1		0.5		4 2 L Glass	E227	1, 2,3,4
	54-G-3	E248.5	1,2,3,4																	1	1			1L G, 11 L Poly	E248.5	1,2,3,4
	54-G-4	54-PAD10E	1,2,3,4																	1		0.5		14 1L Poly	54-PAD10E	1,2,3,4
TA-54 Area L	54-L-1	E223	1,2,3,4																1	1			1L G, 11 L Poly	E223	1,2,3,4	
TA-54 RANT	54-RANT-1	E220	1,2,3,4																1	1			1L G, 11 L Poly	E220	1,2,3,4	
TA-9-28 Heavy Equip Maint	9-HEM-1	09-0028W	1,2,3,4																	1	1			1L G, 11 L Poly	09-0028W	1,2,3,4
TA-54 Maintenance Facility West	54-MFW-1	54-00MFW	Annual																	1			5	4 2 L Glass	54-00MFW	1,2,3,4

*In case of Effluent Limitations Guideline (ELG) exceedance, monitoring must continue.

APPENDIX H1

Sampling Data from Previous Permit Term (MSGP 2008)

9802	Location ID	Date Sampled	Parameter Name	Report Result	Report Units
CASA-09-8232	Sandia below Wetlands	05/05/2009	Hardness	118	mg/L
CASA-09-8233	Sandia below Wetlands	05/05/2009	Hardness	1.24	mg/L
CASA-09-8234	Sandia below Wetlands	05/05/2009	Hardness	116	mg/L
CASA-09-8235	Sandia below Wetlands	05/05/2009	Hardness	1.24	mg/L
CASA-09-8236	Sandia below Wetlands	05/05/2009	Hardness	119	mg/L
CASA-09-8237	Sandia below Wetlands	05/05/2009	Hardness	117	mg/L
CASA-09-10307	Sandia below Wetlands	08/07/2009	Hardness	91.1	mg/L
CASA-09-10309	Sandia below Wetlands	08/07/2009	Hardness	88.5	mg/L
GF090800E12301	Sandia below Wetlands	08/12/2009	Hardness	86.6	mg/L
GU090800E12301	Sandia below Wetlands	08/12/2009	Hardness	59.8	mg/L
GF090900E12301	Sandia below Wetlands	08/23/2009	Hardness	86.8	mg/L
GU090900E12301	Sandia below Wetlands	08/23/2009	Hardness	84.3	mg/L
GF090900E12302	Sandia below Wetlands	08/30/2009	Hardness	50.2	mg/L
GF090900E12303	Sandia below Wetlands	09/10/2009	Hardness	47.8	mg/L
GU090900E12304	Sandia below Wetlands	09/10/2009	Hardness	72.7	mg/L
GF091000E12301	Sandia below Wetlands	10/07/2009	Hardness	65	mg/L
GU091000E12301	Sandia below Wetlands	10/07/2009	Hardness	66.4	mg/L
CASA-10-3594	Sandia below Wetlands	11/04/2009	Hardness	71	mg/L
CASA-10-3595	Sandia below Wetlands	11/04/2009	Hardness	73.5	mg/L
CASA-10-9411	Sandia below Wetlands	01/29/2010	Hardness	370	mg/L
CASA-10-9412	Sandia below Wetlands	01/29/2010	Hardness	373	mg/L
CASA-10-16687	Sandia below Wetlands	05/13/2010	Hardness	66.4	mg/L
CASA-10-16688	Sandia below Wetlands	05/13/2010	Hardness	65.8	mg/L
CASA-10-16689	Sandia below Wetlands	05/13/2010	Hardness	1.24	mg/L
CASA-10-16691	Sandia below Wetlands	05/13/2010	Hardness	66	mg/L
CASA-10-16692	Sandia below Wetlands	05/13/2010	Hardness	64.2	mg/L
CASA-10-22577	Sandia below Wetlands	07/12/2010	Hardness	1.24	mg/L
WTESR-10-19978	Sandia below Wetlands	10/02/2010	Hardness	40.8	mg/L
WTESR-10-19982	Sandia below Wetlands	10/02/2010	Hardness	64.9	mg/L
CASA-11-1334	Sandia below Wetlands	11/11/2010	Hardness	103	mg/L
CASA-11-1335	Sandia below Wetlands	11/11/2010	Hardness	109	mg/L
CASA-11-10788	Sandia below Wetlands	05/17/2011	Hardness	84.3	mg/L
CASA-11-10789	Sandia below Wetlands	05/17/2011	Hardness	92.4	mg/L
CASA-11-10790	Sandia below Wetlands	05/17/2011	Hardness	1.24	mg/L
WTESR-11-16562	Sandia below Wetlands	07/28/2011	Hardness	91.7	mg/L
WTESR-11-16566	Sandia below Wetlands	07/28/2011	Hardness	129	mg/L
WTESR-11-16563	Sandia below Wetlands	08/04/2011	Hardness	74.5	mg/L
WTESR-11-16567	Sandia below Wetlands	08/04/2011	Hardness	121	mg/L
WTESR-12-19536	Sandia below Wetlands	10/12/2012	Hardness	43.4	mg/L
WTESR-12-19548	Sandia below Wetlands	10/12/2012	Hardness	22.7	mg/L
WTESR-14-78920	Sandia below Wetlands	05/23/2014	Hardness	34.6	mg/L
WTESR-14-78921	Sandia below Wetlands	05/23/2014	Hardness	39.5	mg/L
WTESR-14-78922	Sandia below Wetlands	05/23/2014	Hardness	29.8	mg/L
WTESR-14-78929	Sandia below Wetlands	05/23/2014	Hardness	39.2	mg/L
WTESR-14-78930	Sandia below Wetlands	05/23/2014	Hardness	64.6	mg/L

WTESR-14-78931	Sandia below Wetlands	05/23/2014	Hardness	39.1	mg/L
WTESR-14-78938	Sandia below Wetlands	07/07/2014	Hardness	41.2	mg/L
WTESR-14-78939	Sandia below Wetlands	07/07/2014	Hardness	77.3	mg/L
WTESR-14-78940	Sandia below Wetlands	07/07/2014	Hardness	47	mg/L
WTESR-14-78947	Sandia below Wetlands	07/07/2014	Hardness	29.3	mg/L
WTESR-14-78948	Sandia below Wetlands	07/07/2014	Hardness	23.1	mg/L
WTESR-14-78949	Sandia below Wetlands	07/07/2014	Hardness	25.5	mg/L
WTESR-14-78956	Sandia below Wetlands	07/08/2014	Hardness	30.2	mg/L
WTESR-14-78957	Sandia below Wetlands	07/08/2014	Hardness	27.6	mg/L
WTESR-14-78958	Sandia below Wetlands	07/08/2014	Hardness	27.4	mg/L
WTESR-14-78965	Sandia below Wetlands	07/08/2014	Hardness	40.6	mg/L
WTESR-14-78966	Sandia below Wetlands	07/08/2014	Hardness	73.2	mg/L
WTESR-14-78967	Sandia below Wetlands	07/08/2014	Hardness	46.9	mg/L
WTESR-14-78975	Sandia below Wetlands	07/15/2014	Hardness	60.4	mg/L
WTESR-14-78976	Sandia below Wetlands	07/15/2014	Hardness	37.4	mg/L
WTESR-14-78984	Sandia below Wetlands	07/15/2014	Hardness	29.5	mg/L
WTESR-14-78985	Sandia below Wetlands	07/15/2014	Hardness	25.3	mg/L
WTESR-14-78974	Sandia below Wetlands	07/16/2014	Hardness	37.8	mg/L
WTESR-14-78983	Sandia below Wetlands	07/16/2014	Hardness	29.8	mg/L
WTESR-14-85140	Sandia below Wetlands	07/19/2014	Hardness	29.4	mg/L
WTESR-14-85141	Sandia below Wetlands	07/19/2014	Hardness	20.4	mg/L
WTESR-14-85142	Sandia below Wetlands	07/19/2014	Hardness	23.3	mg/L
WTESR-14-85143	Sandia below Wetlands	07/19/2014	Hardness	33.2	mg/L
WTESR-14-85144	Sandia below Wetlands	07/19/2014	Hardness	26.1	mg/L
WTESR-14-85145	Sandia below Wetlands	07/19/2014	Hardness	26.5	mg/L
CASA-14-84047	Sandia below Wetlands	07/21/2014	Hardness	72.2	mg/L
WTESR-14-85613	Sandia below Wetlands	07/29/2014	Hardness	22	mg/L
WTESR-14-85614	Sandia below Wetlands	07/29/2014	Hardness	16.2	mg/L
WTESR-14-85615	Sandia below Wetlands	07/29/2014	Hardness	22.4	mg/L
WTESR-14-85616	Sandia below Wetlands	07/29/2014	Hardness	55.1	mg/L
WTESR-14-85617	Sandia below Wetlands	07/29/2014	Hardness	31	mg/L
WTESR-14-85618	Sandia below Wetlands	07/29/2014	Hardness	32.9	mg/L
WTESR-14-85829	Sandia below Wetlands	07/31/2014	Hardness	125	mg/L
WTESR-14-85830	Sandia below Wetlands	07/31/2014	Hardness	58.9	mg/L
WTESR-14-85831	Sandia below Wetlands	07/31/2014	Hardness	45.3	mg/L
WTESR-14-85832	Sandia below Wetlands	07/31/2014	Hardness	29.7	mg/L
WTESR-14-85833	Sandia below Wetlands	07/31/2014	Hardness	26.9	mg/L
WTESR-14-85834	Sandia below Wetlands	07/31/2014	Hardness	30.3	mg/L
WTESR-15-97798	Sandia below Wetlands	07/03/2015	Hardness	29.8	mg/L
WTESR-15-97801	Sandia below Wetlands	07/03/2015	Hardness	17.3	mg/L
WTESR-15-97883	Sandia below Wetlands	07/03/2015	Hardness	15	mg/L
WTESR-15-97886	Sandia below Wetlands	07/03/2015	Hardness	22.2	mg/L
WTESR-15-97949	Sandia below Wetlands	07/03/2015	Hardness	25.1	mg/L
WTESR-15-97952	Sandia below Wetlands	07/03/2015	Hardness	21	mg/L
CASA-09-8240	Sandia right fork at Pwr Plant	05/07/2009	Hardness	119	mg/L
CASA-09-8241	Sandia right fork at Pwr Plant	05/07/2009	Hardness	117	mg/L
CASA-09-10304	Sandia right fork at Pwr Plant	08/07/2009	Hardness	104	mg/L

CASA-09-10305	Sandia right fork at Pwr Plant	08/07/2009	Hardness	104	mg/L
CASA-10-3558	Sandia right fork at Pwr Plant	11/02/2009	Hardness	80.3	mg/L
CASA-10-3559	Sandia right fork at Pwr Plant	11/02/2009	Hardness	80.9	mg/L
CASA-10-9111	Sandia right fork at Pwr Plant	02/01/2010	Hardness	136	mg/L
CASA-10-9112	Sandia right fork at Pwr Plant	02/01/2010	Hardness	105	mg/L
CASA-10-16680	Sandia right fork at Pwr Plant	05/07/2010	Hardness	81.2	mg/L
CASA-10-16681	Sandia right fork at Pwr Plant	05/07/2010	Hardness	83	mg/L
CASA-11-1337	Sandia right fork at Pwr Plant	11/09/2010	Hardness	129	mg/L
CASA-11-1339	Sandia right fork at Pwr Plant	11/09/2010	Hardness	134	mg/L
CASA-11-1340	Sandia right fork at Pwr Plant	11/09/2010	Hardness	135	mg/L
CASA-11-1341	Sandia right fork at Pwr Plant	11/09/2010	Hardness	129	mg/L
CASA-11-1478	Sandia right fork at Pwr Plant	11/09/2010	Hardness	1.24	mg/L
CASA-11-10791	Sandia right fork at Pwr Plant	05/19/2011	Hardness	87.8	mg/L
CASA-11-10792	Sandia right fork at Pwr Plant	05/19/2011	Hardness	92.5	mg/L
WTESR-12-19538	Sandia right fork at Pwr Plant	07/11/2012	Hardness	640	mg/L
WTESR-12-19550	Sandia right fork at Pwr Plant	07/11/2012	Hardness	321	mg/L
WTESR-12-19541	Sandia right fork at Pwr Plant	07/25/2012	Hardness	27.2	mg/L
WTESR-12-19553	Sandia right fork at Pwr Plant	07/25/2012	Hardness	20.9	mg/L
WTESR-12-19537	Sandia right fork at Pwr Plant	09/10/2012	Hardness	41.1	mg/L
WTESR-12-19549	Sandia right fork at Pwr Plant	09/10/2012	Hardness	24	mg/L
WTESR-12-19544	Sandia right fork at Pwr Plant	09/28/2012	Hardness	32.2	mg/L
WTESR-12-19556	Sandia right fork at Pwr Plant	09/28/2012	Hardness	21.9	mg/L
WTESR-13-33544	Sandia right fork at Pwr Plant	06/30/2013	Hardness	59.8	mg/L
WTESR-13-33547	Sandia right fork at Pwr Plant	06/30/2013	Hardness	26.4	mg/L
WTESR-13-33550	Sandia right fork at Pwr Plant	07/12/2013	Hardness	18.2	mg/L
WTESR-13-33553	Sandia right fork at Pwr Plant	07/12/2013	Hardness	56.1	mg/L
CASA-13-37021	Sandia right fork at Pwr Plant	07/22/2013	Hardness	51.8	mg/L
WTESR-13-33556	Sandia right fork at Pwr Plant	09/12/2013	Hardness	20.3	mg/L
WTESR-13-33559	Sandia right fork at Pwr Plant	09/12/2013	Hardness	12.8	mg/L
WTESR-14-78926	Sandia right fork at Pwr Plant	07/07/2014	Hardness	35.6	mg/L
WTESR-14-78927	Sandia right fork at Pwr Plant	07/07/2014	Hardness	12.3	mg/L
WTESR-14-78928	Sandia right fork at Pwr Plant	07/07/2014	Hardness	26	mg/L
WTESR-14-78935	Sandia right fork at Pwr Plant	07/07/2014	Hardness	41.2	mg/L
WTESR-14-78936	Sandia right fork at Pwr Plant	07/07/2014	Hardness	22	mg/L
WTESR-14-78937	Sandia right fork at Pwr Plant	07/07/2014	Hardness	35.7	mg/L
WTESR-14-78945	Sandia right fork at Pwr Plant	07/15/2014	Hardness	43.4	mg/L
WTESR-14-78946	Sandia right fork at Pwr Plant	07/15/2014	Hardness	37.8	mg/L
WTESR-14-78954	Sandia right fork at Pwr Plant	07/15/2014	Hardness	11.7	mg/L
WTESR-14-78962	Sandia right fork at Pwr Plant	07/15/2014	Hardness	14.8	mg/L
WTESR-14-78963	Sandia right fork at Pwr Plant	07/15/2014	Hardness	10.3	mg/L
WTESR-14-78964	Sandia right fork at Pwr Plant	07/15/2014	Hardness	15.6	mg/L
WTESR-14-78971	Sandia right fork at Pwr Plant	07/15/2014	Hardness	25.2	mg/L
WTESR-14-78972	Sandia right fork at Pwr Plant	07/15/2014	Hardness	52.1	mg/L
WTESR-14-78973	Sandia right fork at Pwr Plant	07/15/2014	Hardness	28.6	mg/L
WTESR-14-78980	Sandia right fork at Pwr Plant	07/19/2014	Hardness	45.8	mg/L
WTESR-14-78981	Sandia right fork at Pwr Plant	07/19/2014	Hardness	94.7	mg/L
WTESR-14-78982	Sandia right fork at Pwr Plant	07/19/2014	Hardness	41.6	mg/L

WTESR-14-78989	Sandia right fork at Pwr Plant	07/19/2014	Hardness	35.3	mg/L
WTESR-14-78990	Sandia right fork at Pwr Plant	07/19/2014	Hardness	11.4	mg/L
WTESR-14-78991	Sandia right fork at Pwr Plant	07/19/2014	Hardness	25.4	mg/L
CASA-14-84048	Sandia right fork at Pwr Plant	07/21/2014	Hardness	67.2	mg/L
WTESR-14-85576	Sandia right fork at Pwr Plant	07/27/2014	Hardness	23.1	mg/L
WTESR-14-85577	Sandia right fork at Pwr Plant	07/27/2014	Hardness	26	mg/L
WTESR-14-85578	Sandia right fork at Pwr Plant	07/27/2014	Hardness	37.2	mg/L
WTESR-14-85579	Sandia right fork at Pwr Plant	07/27/2014	Hardness	43.4	mg/L
WTESR-14-85580	Sandia right fork at Pwr Plant	07/27/2014	Hardness	30.7	mg/L
WTESR-14-85581	Sandia right fork at Pwr Plant	07/27/2014	Hardness	38.9	mg/L
WTESR-14-85836	Sandia right fork at Pwr Plant	07/31/2014	Hardness	76.6	mg/L
WTESR-14-85837	Sandia right fork at Pwr Plant	07/31/2014	Hardness	30.4	mg/L
WTESR-14-85838	Sandia right fork at Pwr Plant	07/31/2014	Hardness	33.9	mg/L
WTESR-14-85839	Sandia right fork at Pwr Plant	07/31/2014	Hardness	18.7	mg/L
WTESR-14-85840	Sandia right fork at Pwr Plant	07/31/2014	Hardness	19.8	mg/L
WTESR-14-85841	Sandia right fork at Pwr Plant	07/31/2014	Hardness	28.1	mg/L
WTESR-15-97800	Sandia right fork at Pwr Plant	06/01/2015	Hardness	40.8	mg/L
WTESR-15-97803	Sandia right fork at Pwr Plant	06/01/2015	Hardness	17.2	mg/L
WTESR-15-97885	Sandia right fork at Pwr Plant	06/01/2015	Hardness	25.9	mg/L
WTESR-15-97888	Sandia right fork at Pwr Plant	06/01/2015	Hardness	30.3	mg/L
WTESR-15-97951	Sandia right fork at Pwr Plant	06/01/2015	Hardness	42.1	mg/L
WTESR-15-97954	Sandia right fork at Pwr Plant	06/01/2015	Hardness	40.8	mg/L
WTESR-15-97818	Sandia right fork at Pwr Plant	06/26/2015	Hardness	22	mg/L
WTESR-15-97821	Sandia right fork at Pwr Plant	06/26/2015	Hardness	23.3	mg/L
WTESR-15-97879	Sandia right fork at Pwr Plant	06/26/2015	Hardness	23.5	mg/L
WTESR-15-97882	Sandia right fork at Pwr Plant	06/26/2015	Hardness	14.7	mg/L
WTESR-15-97945	Sandia right fork at Pwr Plant	06/26/2015	Hardness	14	mg/L
WTESR-15-97948	Sandia right fork at Pwr Plant	06/26/2015	Hardness	16	mg/L
WTESR-15-97939	Sandia right fork at Pwr Plant	07/03/2015	Hardness	31.3	mg/L
WTESR-15-97942	Sandia right fork at Pwr Plant	07/03/2015	Hardness	11.4	mg/L
WTESR-15-97897	Sandia right fork at Pwr Plant	07/03/2015	Hardness	21.5	mg/L
WTESR-15-97900	Sandia right fork at Pwr Plant	07/03/2015	Hardness	26.9	mg/L
WTESR-15-97812	Sandia right fork at Pwr Plant	07/03/2015	Hardness	21.4	mg/L
WTESR-15-97815	Sandia right fork at Pwr Plant	07/03/2015	Hardness	11.5	mg/L

Location ID	Date Sampled	Field Sample ID	Parameter Name	Report Result	Report Units	Analysis Date	Report MDL
03-0038W	05/02/2010	WTMSGP-10-14753	Zinc	231	ug/L	06/08/2010	2.6
03-0038W	05/02/2010	WTMSGP-10-14753	Nitrate-Nitrite as Nitrogen	0.75	mg/L	05/17/2010	0.05
03-0038W	05/02/2010	WTMSGP-10-14753	Gross alpha	12.7	pCi/L	06/07/2010	
03-0038W	05/02/2010	WTMSGP-10-14753	Iron	2320	ug/L	06/08/2010	10
03-0038W	05/02/2010	WTMSGP-10-14753	Mercury	0.066	ug/L	05/18/2010	0.066
03-0038W	05/02/2010	WTMSGP-10-14753	Aluminum	2980	ug/L	06/08/2010	10
03-0038W	05/27/2010	WTMSGP-10-17094	Aroclor-1262	0.0469	ug/L	06/24/2010	0.047
03-0038W	05/27/2010	WTMSGP-10-17094	Aroclor-1242	0.0469	ug/L	06/24/2010	0.047
03-0038W	05/27/2010	WTMSGP-10-17094	Aroclor-1260	0.0469	ug/L	06/24/2010	0.047
03-0038W	05/27/2010	WTMSGP-10-17094	Aroclor-1254	0.0469	ug/L	06/24/2010	0.047
03-0038W	05/27/2010	WTMSGP-10-17094	Aroclor-1221	0.0469	ug/L	06/24/2010	0.047
03-0038W	05/27/2010	WTMSGP-10-17094	Aroclor-1016	0.0469	ug/L	06/24/2010	0.047
03-0038W	05/27/2010	WTMSGP-10-17094	Aroclor-1248	0.0469	ug/L	06/24/2010	0.047
03-0038W	05/27/2010	WTMSGP-10-17094	Aroclor-1232	0.0469	ug/L	06/24/2010	0.047
03-0038W	06/27/2010	WTMSGP-10-14754	Aluminum	2240	ug/L	07/22/2010	10
03-0038W	06/27/2010	WTMSGP-10-14754	Iron	2730	ug/L	07/22/2010	10
03-0038W	06/27/2010	WTMSGP-10-14754	Nitrate-Nitrite as Nitrogen	0.755	mg/L	07/07/2010	0.05
03-0038W	06/27/2010	WTMSGP-10-14754	Zinc	505	ug/L	07/29/2010	26
03-0038W	08/09/2010	WTMSGP-10-14755	Zinc	472	ug/L	09/02/2010	2.6
03-0038W	08/09/2010	WTMSGP-10-14755	Nitrate-Nitrite as Nitrogen	0.555	mg/L	08/17/2010	0.05
03-0038W	08/09/2010	WTMSGP-10-14755	Iron	1840	ug/L	09/02/2010	10
03-0038W	08/09/2010	WTMSGP-10-14755	Aluminum	1230	ug/L	09/03/2010	10
03-0038W	10/01/2010	WTMSGP-10-14756	Aluminum	11000	ug/L	11/02/2010	100
03-0038W	10/01/2010	WTMSGP-10-14756	Iron	8720	ug/L	11/02/2010	100
03-0038W	10/01/2010	WTMSGP-10-14756	Nitrate-Nitrite as Nitrogen	0.05	mg/L	10/13/2010	0.05
03-0038W	10/01/2010	WTMSGP-10-14756	Zinc	1130	ug/L	11/02/2010	52
03-0038W	04/06/2011	WTMSGP-11-6404	Zinc	534	ug/L	04/25/2011	35
03-0038W	04/06/2011	WTMSGP-11-6404	Copper	42.7	ug/L	04/28/2011	0.35
03-0038W	07/27/2011	WTMSGP-11-6405	Zinc	564	ug/L	08/17/2011	3.5
03-0038W	08/22/2011	WTMSGP-11-6406	Zinc	858	ug/L	09/03/2011	3.5
03-0038W	10/04/2011	WTMSGP-11-6407	Zinc	750	ug/L	10/20/2011	35
03-0038W	04/02/2012	WTMSGP-12-12963	Zinc	147	ug/L	04/26/2012	3.5
03-0038W	07/02/2012	WTMSGP-12-12968	Zinc	860	ug/L	07/17/2012	3.5
03-0038W	08/02/2012	WTMSGP-12-12979	Zinc	451	ug/L	09/05/2012	3.5
03-0038W	04/09/2013	WTMSGP-13-29839	Zinc	628	ug/L	05/14/2013	35.0
03-0038W	06/29/2013	WTMSGP-13-29840	Zinc	634	ug/L	08/01/2013	3.5
03-0038W	08/18/2013	WTMSGP-13-29841	Zinc	723	ug/L	09/14/2013	3.5
03-0038W	11/22/2013	WTMSGP-13-29842	Zinc	363	ug/L	01/27/2014	3.5
03-0038W	05/23/2014	MSGP-14-56729	Zinc	767	ug/L	06/19/2014	3.3
03-0038W	07/10/2014	MSGP-14-56730	Zinc	455	ug/L	08/07/2014	3.5
03-0038W	08/01/2014	MSGP-14-56731	Zinc	1370	ug/L	08/29/2014	3.5
03-0038W	04/26/2015	MSGP-15-95629	Thallium	0.45	ug/L	05/08/2015	0.45
03-0038W	04/26/2015	MSGP-15-95630	Zinc	109	ug/L	05/08/2015	3.5

APPENDIX I

Records of Employee Training Related to the SWPPP

APPENDIX J
Corrective Action Reports

MSGP CORRECTIVE ACTION REPORT

Corrective Action Header Corrective Action Details

3. Identify the condition triggering the need for this review: If other, (describe here):
 Control measures inadequate to meet applicable wa

4. Briefly describe the nature of problem identified: (e.g., Erosion problem identified during inspection).
 At the TA-3-38 Metal Fabrication Shop, a persistent sheen is present in the trench drain west of the shop.

6. How problem was identified: If other, (describe here):
 Other (describe) : Facility personnel observing the drain.

7. Description of corrective action taken or to be taken to eliminate or further investigate the problem (e.g., describe modifications, repairs to control measures, analyses to be conducted, etc.) or if no modifications are needed, basis for that determination:
 Per facility personnel, the trench drain is not on a routine maintenance schedule for clean out. This needs to be corrected. In addition, a Petro-Plug or oil/water separator needs to be added to the system to prevent oil from discharging in the future. The facility must immediately take action to minimize off site discharge of the

8. Did/will this corrective action require modification of your SWPPP ? Yes/No :

9. Date corrective action initiated (MM/DD/YYYY):

10. Date corrective action completed (MM/DD/YYYY): OR expected completion :

11. If corrective action not yet completed, provide the status of corrective action at the time of the comprehensive site inspection and describe any remaining steps (including time frames associated with each step) necessary to complete corrective action:
 A Petro-Plug or oil/water separator needs to be added to the system to prevent oil from discharging in the future. The trench drain needs to be placed on a routine maintenance schedule for clean out. The 2015 MSGP SWPPP must be modified within 14 days of completing this corrective action to reflect the implementation of new control measures like routine maintenance and/or the addition of a Petro-Plug.

* required fields

MSGP CORRECTIVEACTIONREPORT

Corrective Action Header Corrective Action Details

3. Identify the condition triggering the need for this review: If other, (describe here):

4. Briefly describe the nature of problem identified: (e.g., Erosion problem identified during inspection).

6. How problem was identified: If other, (describe here):

7. Description of corrective action taken or to be taken to eliminate or further investigate the problem (e.g., describe modifications, repairs to control measures, analyses to be conducted, etc.) or if no modifications are needed, basis for that determination:

8. Did/will this corrective action require modification of your SWPPP ? Yes/No :

9. Date corrective action initiated (MM/DD/YYYY):

10. Date corrective action completed (MM/DD/YYYY): OR expected completion :

11. If corrective action not yet completed, provide the status of corrective action at the time of the comprehensive site inspection and describe any remaining steps (including time frames associated with each step) necessary to complete corrective action:

* required fields

List Values Prev Rec. Next Rec. BackToRecordSelection Save Cancel

MSGP CORRECTIVEACTIONREPORT

Corrective Action Header Corrective Action Details

3. Identify the condition triggering the need for this review: If other, (describe here):

4. Briefly describe the nature of problem identified: (e.g., Erosion problem identified during inspection).
At the TA-3-38 Metals Fabrication Shop, the blue roll off bin containing metal shavings was leaking an oily substance.

6. How problem was identified: If other, (describe here):

7. Description of corrective action taken or to be taken to eliminate or further investigate the problem (e.g., describe modifications, repairs to control measures, analyses to be conducted, etc.) or if no modifications are needed, basis for that determination:

8. Did/will this corrective action require modification of your SWPPP ? Yes/No :

9. Date corrective action initiated (MM/DD/YYYY):

10. Date corrective action completed (MM/DD/YYYY): OR expected completion :

11. If corrective action not yet completed, provide the status of corrective action at the time of the comprehensive site inspection and describe any remaining steps (including time frames associated with each step) necessary to complete corrective action:

* required fields

List Values Prev Rec. Next Rec. BackToRecordSelection Save Cancel

3. Identify the condition triggering the need for this review: If other, (describe here):

Unauthorized release or discharge

4. Briefly describe the nature of problem identified: (e.g., Erosion problem identified during inspection).

At the TA-3-38 Metals Fabrication Shop, metal stored in the following areas needs to be covered:
-a raised metal cage metal storage container on the north end of the metal storage yard,
-rusted metal grating in the metal storage area, and
-sheet metal on the north metal storage rack next to East James Road. Piping in the rack on the southeast

6. How problem was identified: If other, (describe here):

Comprehensive site inspection

7. Description of corrective action taken or to be taken to eliminate or further investigate the problem (e.g., describe modifications, repairs to control measures, analyses to be conducted, etc.) or if no modifications are needed, basis for that determination:

Cover the metal identified above or store it in a storm resistant shelter. Restack the metal piping.

8. Did/will this corrective action require modification of your SWPPP ? Yes/No :

9. Date corrective action initiated (MM/DD/YYYY):

10. Date corrective action completed (MM/DD/YYYY): OR expected completion :

11. If corrective action not yet completed, provide the status of corrective action at the time of the comprehensive site inspection and describe any remaining steps (including time frames associated with each step) necessary to complete corrective action:

Cover the metal identified above or store it in a storm resistant shelter. Restack the metal piping.

* required fields

List Values

Prev Rec.

Next Rec.

BackToRecordSelection

Save

Cancel

Appendix J1

Documentation of Repairs and Maintenance of Control Measures (BMPs)

Burgin, Jillian E

From: FSR <ops-fp-fmu@lanl.gov>
Sent: Thursday, January 07, 2016 2:47 PM
To: Burgin, Jillian E
Subject: 030038 storm drain clean out - ENV non-compliance ISSUE=144268 PROJ=13

When replying, type your text above this line.

Notification of Issue Change

The following changes have been made to this Issue: *Changed Status to Closed from Open, Appended a Description, Survey sent to rdstone@lanl.gov, Escalated: Date Closed, Changed Date Closed to 01/07/2016 2:47 PM.*

Workspace: Facility Service Request (FSR)
Issue: 030038 storm drain clean out - ENV non-compliance
Issue Number:144268

Priority: Urgent **Status:** Closed
Date: 01/07/2016 **Time:** 14:47:15
Creation Date:10/28/2015 **Creation Time:**10:38:44
Created By: 117365

Description:

Entered on 01/07/2016 at 2:47:11 PM MST (GMT-0700) by Michael F. Martinez:
Cleaned drain, complete per Gary McMillan

Entered on 01/05/2016 at 8:02:18 AM MST (GMT-0700) by Michael F. Martinez:
Assigned to Gary McMillan , Schedule to work 1/5/16

Entered on 12/02/2015 at 2:01:29 PM MST (GMT-0700) by James Rabold:
Russell, per our discussion you will need to get Michael F. Martinez at roads and grounds to initiate a work order to have their crews perform this service. I don't see any activity from their end to date on your FSR. Please let me know if you have any issues with this path. Jim R.

Entered on 10/28/2015 at 3:50:33 PM MDT (GMT-0600) by rdstone@lanl.gov:
Additional step for cleaning the sludge is to remove the water prior to cleaning the sludge from the drain. There is a sump pump in the drain which is connected by cord and plug. This can be used to pump off water prior to removing the sludge.

Russell Stone, CSP
ESH Manager (acting)
Utilities and Infrastructure
Office 606-0071
Cell 500-6244
Schedule A

Entered on 10/28/2015 at 12:47:11 PM MDT (GMT-0600) by rdstone@lanl.gov:
DSESH-UI cost codes will purchase containers for this specific work evolution. The traffic engineer has stated that the storm drain will be put on a PM that will start next spring and containers will be purchased as necessary as part of that PM package.

Russell Stone, CSP
ESH Manager (acting)
Utilities and Infrastructure
Office 606-0071
Cell 500-6244
Schedule A

Entered on 10/28/2015 at 12:18:43 PM MDT (GMT-0600) by algarcia@lanl.gov:

Cost string will be needed to purchase containers.

Entered on 10/28/2015 at 10:38:44 AM MDT (GMT-0600) by 117365:

The storm drain just outside the plumbers fabrication shop (northwest corner, bottom of the ramp) has a layer of oily sludge in the bottom. The sludge must be removed and containerized. Please contact Audrey Garcia (665-4914) for containers. This is an environmental non-compliance and must be completed by 11/5/2015.

Current Assignees: Allen J. Romero, Anthony R. Casados, James Rabold, Michael F. Martinez, David Olivas, Phillip E. Ulibarri, Bill Schleft

Issue Information:

Services:	Maintenance	Requesting Group:	DSESH-UI
TA-:	03	BLDG-:	Roads/Grounds/Parking Lots
Roads & Grounds BLDG::	0038	BAS Service:	BAS Craft
Room-:	outside	Unreviewed Safety Question (USQ)?:	No
Cost Center::	8V070A	Program Code::	XFM3
Cost Account::	0502	Work Package::	0300
Requested Completion Date:	11/05/2015		

Contact Information:

Z Number: 117365	Name: Russell Stone
Div-Group: DSESH-UI	Phone: +1 505 606 0071
Pager: +1 505 664 1345	E-mail: rdstone@lanl.gov

PFC-44 Pre-Filter Canister Maintenance

The PFC-44 pre-filter is designed to stop dirt from getting to the oil stopping media of the Petro-Pipe®. As routine maintenance the contents should be cleaned or changed when a restricted water flow is noticed. One set of replacement material is included with your filter.

DO NOT USE THE PETRO-PIPE® WITHOUT THE PRE-FILTER IN PLACE!

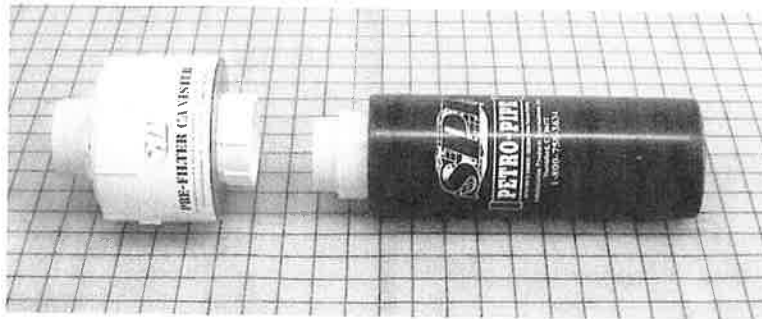
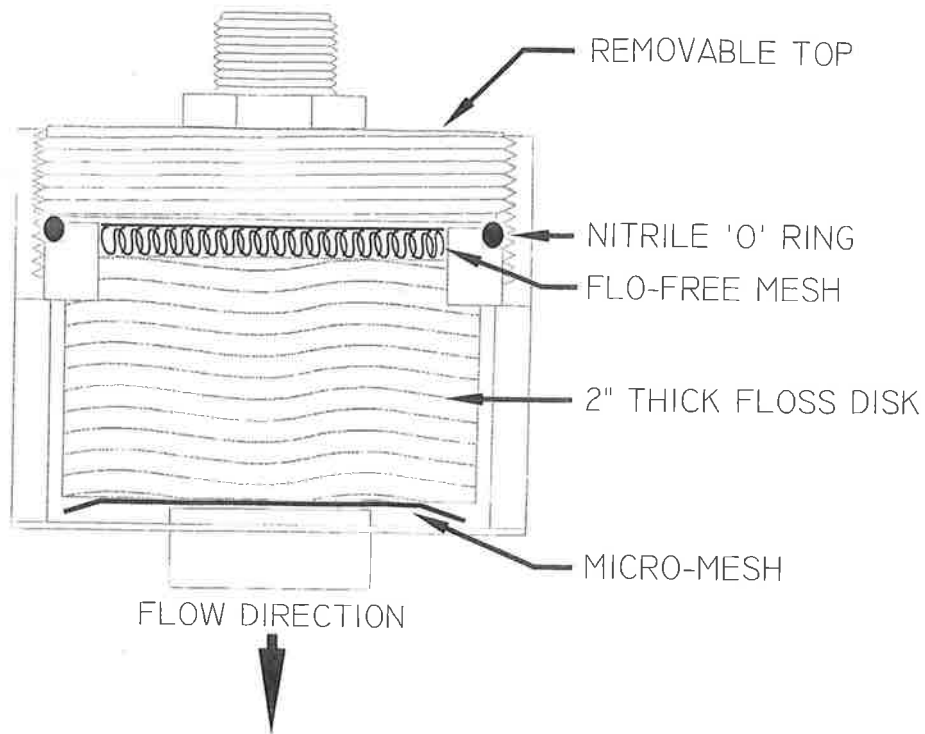

Purchase Pre-filter replacement kits from your dealer.



PFC-44 PRE-FILTER Canister Maintenance

The PFC-44 pre-filter is designed to stop dirt from getting to the oil stopping media of the Petro-Pipe®. As routine maintenance the contents should be cleaned or changed when a restricted water flow is noticed. One set of replacement material is included with your filter.

DO NOT USE THE PETRO-PIPE® WITHOUT THE PRE-FILTER IN PLACE!

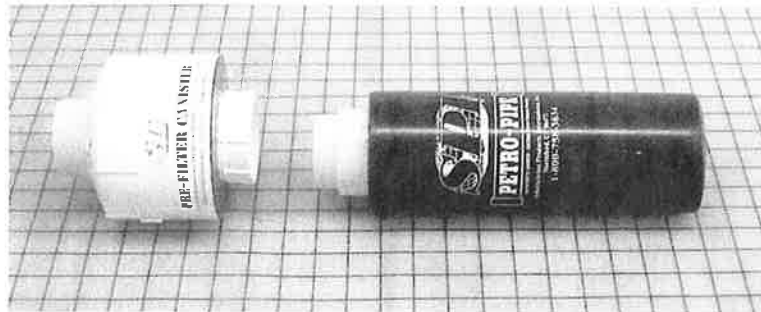
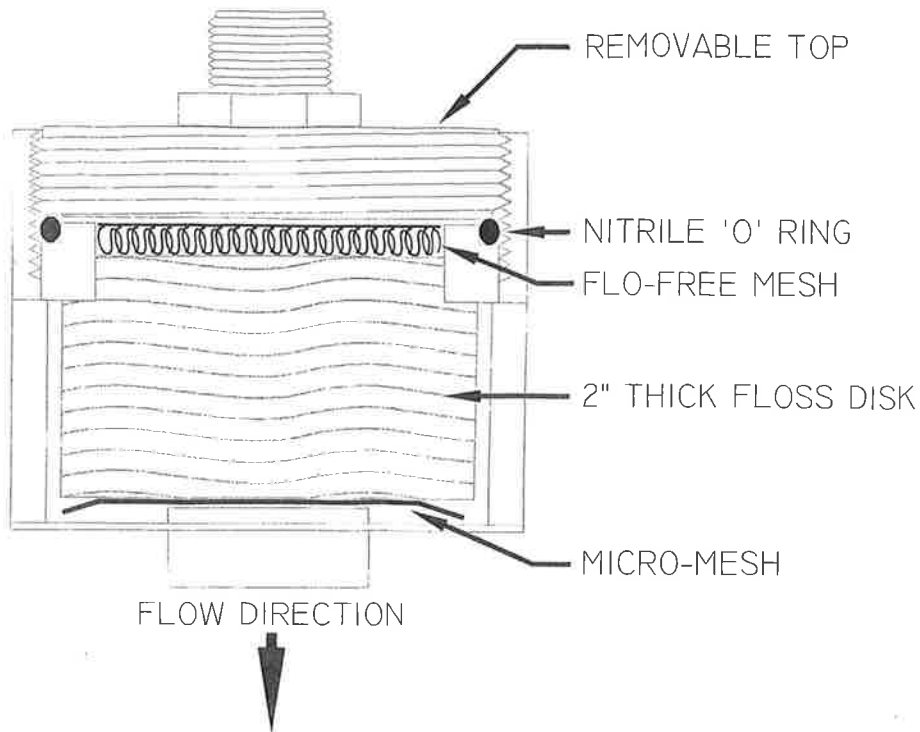

Purchase Pre-filter replacement kits from your dealer.

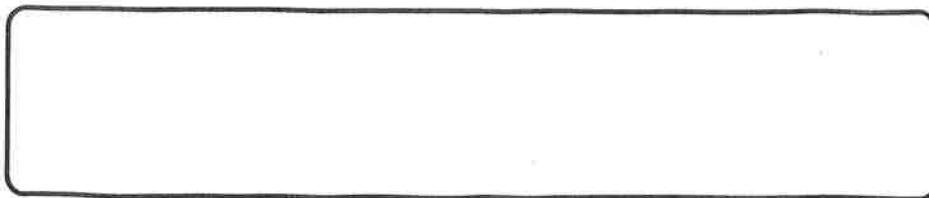

POST OFFICE BOX 35 • NORTHFORD, CT • 06472
PHONE: 1-800-758-3634 • FAX: 203-484-9492

US Patent #s 6485639, 6503390, 6841077 • CA Patent 2400505 Copyright © 2013

I-PVC-44-01

Appendix K

Critical Habitat Documentation for LANL

K-1, Threatened and Endangered Species Habitat Management Plan (HMP) for LANL

K-2, U.S. Fish & Wildlife Concurrence
(Biological Assessment of Jemez Mtn Salamander Site Plan)

K-3, TA-3 and TA-60 IPac Trust Resource Report

K-1, Threatened and Endangered Species Habitat Management Plan
(HMP) for LANL

LA-UR-14-21863

*Approved for public release;
distribution is unlimited.*

Title: **Threatened and Endangered Species
Habitat Management Plan for
Los Alamos National Laboratory**

Author(s): Environmental Protection Division
Resources Management Team

Intended for: Reference purposes

Date: March 2014



Los Alamos National Laboratory, an affirmative action/equal opportunity employer, is operated by the Los Alamos National Security, LLC for the National Nuclear Security Administration of the U.S. Department of Energy under contract DE-AC52-06NA25396. By acceptance of this article, the publisher recognizes that the U.S. Government retains a nonexclusive, royalty-free license to publish or reproduce the published form of this contribution, or to allow others to do so, for U.S. Government purposes. Los Alamos National Laboratory requests that the publisher identify this article as work performed under the auspices of the U.S. Department of Energy. Los Alamos National Laboratory strongly supports academic freedom and a researcher's right to publish; as an institution, however, the Laboratory does not endorse the viewpoint of a publication or guarantee its technical correctness.

Contents

ACRONYMS.....	vii
I. THREATENED AND ENDANGERED SPECIES HABITAT MANAGEMENT PLAN	
GENERAL OVERVIEW.....	1
1.0 INTRODUCTION	1
2.0 ROLE OF SITE PLANS IN THE HMP	1
3.0 DESCRIPTION OF AREAS OF ENVIRONMENTAL INTEREST	1
3.1 Definition and Role of Developed Areas in AEI Management	1
3.2 General Description of Buffer Areas and Allowable Buffer Area Development	2
3.3 Emergency Actions	3
4.0 IMPLEMENTATION OF SITE PLANS.....	3
4.1 Roles and Responsibilities	3
4.2 If an Activity Does Not Meet Site Plan Guidelines	4
4.3 Dissemination of Information	5
5.0 CHANGES IN THE HMP SINCE IMPLEMENTATION	5
6.0 DATA MANAGEMENT.....	5
II. AREA OF ENVIRONMENTAL INTEREST SITE PLAN FOR THE MEXICAN SPOTTED OWL	6
1.0 SPECIES DESCRIPTION—MEXICAN SPOTTED OWL	6
1.1 Status.....	6
1.2 General Biology	6
1.3 Threats.....	7
2.0 IMPACT OF HUMAN ACTIVITIES	7
2.1 Introduction.....	7
2.2 Impacts on Habitat Quality	7
2.2.1 Development	7
2.2.2 Ecological Risk	7
2.2.3 Disturbance	8
2.2.3.1 Pedestrians and Vehicles.....	8
2.2.3.2 Aircraft.....	8
2.2.3.3 Explosives.....	8
2.2.3.4 Other Sources of Noise	9
2.2.3.5 Artificially Produced Light	11
3.0 AEI GENERAL DESCRIPTION FOR MEXICAN SPOTTED OWL	11
3.1 Method for Identifying a Mexican Spotted Owl AEI	12
3.2 Location and Number of Mexican Spotted Owl AEIs	12
4.0 AEI MANAGEMENT	12
4.1 Overview.....	12
4.2 Definition and Role of Occupancy in AEI Management	13

4.3	Introduction to AEI Management Guidelines	13
4.4	Definition of and Restrictions on Habitat Alterations.....	14
4.4.1	Definition of Habitat Alterations	14
4.4.2	Fuels Management Practices to Reduce Wildfire Risk.....	14
4.4.3	Utility Corridors.....	15
4.4.4	Restrictions on Habitat Alterations	15
4.5	Definition of and Restrictions on Disturbance Activities	15
4.5.1	Definitions of Disturbance Activities.....	15
4.5.2	Activity Table	17
4.6	Protective Measures	18
5.0	LEVELS OF DEVELOPMENT IN AEI CORE AND BUFFERS.....	19
5.1	Allowable Habitat Alteration in the Buffer Areas	19
III. AREA OF ENVIRONMENTAL INTEREST SITE PLAN FOR THE SOUTHWESTERN WILLOW FLYCATCHER.....		20
1.0	SPECIES DESCRIPTION—SOUTHWESTERN WILLOW FLYCATCHER.....	20
1.1	Status.....	20
1.2	General Biology	20
1.3	Threats.....	21
2.0	IMPACT OF HUMAN ACTIVITIES	21
2.1	Introduction.....	21
2.2	Impacts on Habitat Quality	21
2.2.1	Development	21
2.2.2	Ecological Risk	22
2.2.2.1	Ecorisk Assessment	22
2.2.3	Disturbance	22
2.2.3.1	Pedestrians and Vehicles.....	22
2.2.3.2	Aircraft.....	22
2.2.3.3	Explosives.....	23
2.2.3.4	Other Sources of Noise	23
2.2.3.5	Artificially Produced Light	23
3.0	AEI GENERAL DESCRIPTION FOR SOUTHWESTERN WILLOW FLYCATCHER.....	23
3.1	Method for Identifying the Southwestern Willow Flycatcher AEI.....	23
3.2	Location of the Southwestern Willow Flycatcher AEI	23
4.0	AEI MANAGEMENT	24
4.1	Overview.....	24
4.2	Definition and Role of Occupancy in AEI Management	24
4.3	Introduction to AEI Management Guidelines	24
4.4	Definition of and Restrictions on Habitat Alterations.....	25
4.4.1	Definition of Habitat Alterations	25
4.4.2	Fuels Management Practices to Reduce Wildfire Risk.....	25

Threatened and Endangered Species Habitat Management Plan

4.4.3	Utility Corridors	25
4.4.4	Restrictions on Habitat Alterations	26
4.5	Definition of and Restrictions on Disturbance Activities	26
4.5.1	Definition of Disturbance Activities	26
4.5.2	Activity Table	27
4.6	Protective Measures	28
5.0	SOUTHWESTERN WILLOW FLYCATCHER AEI DESCRIPTION	29
5.1	Pajarito Canyon Southwestern Willow Flycatcher AEI.....	29
5.1.1	Allowable Habitat Alteration in the Buffer Area.....	29
IV. AREA OF ENVIRONMENTAL INTEREST SITE PLAN FOR THE JEMEZ MOUNTAINS SALAMANDER		
SALAMANDER		
1.0	SPECIES DESCRIPTION—JEMEZ MOUNTAINS SALAMANDER	29
1.1	Status.....	29
1.2	General Biology	29
1.3	Threats.....	30
2.0	IMPACT OF HUMAN ACTIVITIES	30
2.1	Introduction.....	30
2.2	Impacts on Habitat Quality	30
2.2.1	Development	30
2.2.2	Pedestrians and Vehicles.....	30
2.2.3	Severe Wildland Fire and Wildfire Suppression.....	31
2.3	Impacts on Individual Salamanders	31
2.3.1	Disease 31	
2.3.2	Destruction of Individual Salamanders.....	31
3.0	AEI GENERAL DESCRIPTION FOR JEMEZ MOUNTAINS SALAMANDER.....	31
3.1	Method for Identifying a Jemez Mountains Salamander AEI.....	32
3.2	Location and Number of Jemez Mountains Salamander AEIs	33
4.0	AEI MANAGEMENT	33
4.1	Overview.....	33
4.2	Definition and Role of Occupancy in AEI Management.....	33
4.3	Definition and Role of Developed Areas in AEI Management	34
4.4	General Description of Core and Buffer Areas and Allowable Area Development	34
4.5	Emergency Actions.....	34
4.6	Introduction to AEI Management Guidelines	34
4.7	Definition of and Restrictions on Habitat Alterations.....	34
4.7.1	Definition of Habitat Alterations	34
4.7.2	Fuels Management Practices to Reduce Wildfire Risk.....	35
4.7.3	Utility Corridors.....	35
4.7.4	Restrictions on Habitat Alterations	35

REFERENCES CITED 36
APPENDIX..... 41

Figure

Figure 1. Process flowchart for determining site plan requirements. 4

Tables

Table 1. Restrictions on Activities in Undeveloped Occupied Mexican Spotted Owl AEIs... 18
Table 2. Restrictions on Activities in Undeveloped Occupied Southwestern Willow
Flycatcher AEI 28
Table A-1. The percentage of each food type found in Mexican Spotted Owl food remains
at LANL 41
Table A-2. Preliminary light measurements in ftc for Mexican Spotted Owl site plan..... 41

ACRONYMS

AEI	Area of Environmental Interest
BA	biological assessment
Bd	Batrachochytrium dendrobatidis
BSL-3	Biosafety Level 3
COPCs	chemicals of potential concern
DARHT	Dual-Axis Radiographic Hydrodynamic Test (Facility)
dB	Decibel
DDT	(dichloro-diphenyl-trichloroethane)
DOE	U.S. Department of Energy
EPA	Environmental Protection Agency
ESA	Endangered Species Act of 1973
fc	foot candles
FR	Federal Register
GIS	geographic information system
HMP	Threatened and Endangered Species Habitat Management Plan
HVAC	heating, ventilation, and air conditioning
LANL	Los Alamos National Laboratory
NEPA	National Environmental Policy Act
NMED	New Mexico Environment Department
NPDES	National Pollutant Discharge Eliminations System
PCBs	polychlorinated biphenyls
PR-ID	Permits and Requirements Identification
SME	subject matter expert
USFWS	U.S. Fish and Wildlife Service

I. THREATENED AND ENDANGERED SPECIES HABITAT MANAGEMENT PLAN GENERAL OVERVIEW

1.0 INTRODUCTION

Los Alamos National Laboratory's (LANL) Threatened and Endangered Species Habitat Management Plan (HMP) was prepared to fulfill a commitment made in the U.S. Department of Energy's (DOE) "Final Environmental Impact Statement for the Dual-Axis Radiographic Hydrodynamic Test Facility Mitigation Action Plan" (DOE 1996). The HMP received concurrence from the U.S. Fish and Wildlife Service (USFWS) in 1999 (USFWS consultation numbers 2-22-98-I-336 and 2-22-95-I-108). In this 2014 update, we retained the management guidelines from the 1999 HMP for listed species, updated some descriptive information, and added the Jemez Mountains salamander (*Plethodon neomexicanus*), which was federally listed in September 2013 (USFWS consultation number 02ENNM00-2014-I-0014).

2.0 ROLE OF SITE PLANS IN THE HMP

The purpose of the HMP is to provide a management strategy for the protection of threatened and endangered species and their habitats on LANL property. The HMP consists of site plans for federally listed threatened or endangered species with a moderate or high probability of occurring at LANL. The following federally listed threatened or endangered species currently have site plans at LANL: Mexican Spotted Owl (*Strix occidentalis lucida*), Southwestern Willow Flycatcher (*Empidonax trailii extimus*), and the Jemez Mountains salamander. Site plans provide guidance to ensure that LANL operations do not adversely affect threatened or endangered species or their habitats.

3.0 DESCRIPTION OF AREAS OF ENVIRONMENTAL INTEREST

Suitable habitats for federally listed threatened and endangered species have been designated as Areas of Environmental Interest (AEIs). AEIs are geographical units at LANL that are managed for the protection of federally listed species and consist of core habitat areas and buffer areas. The purpose of the core habitat is to protect areas essential for the existence of the specific threatened or endangered species. This includes the appropriate habitat type for breeding, prey availability, and micro-climate conditions. The purpose of buffer areas is to protect core areas from undue disturbance and habitat degradation.

Site plans identify restrictions on activities within the AEIs. Allowable activities are activities that the USFWS has reviewed and provided concurrence that these activities are not likely to adversely affect federally listed species. Activities discussed in site plans include day-to-day activities causing disturbance (hereafter referred to as "disturbance activities"), such as access into an AEI, and long-term impacts, such as habitat alteration.

3.1 Definition and Role of Developed Areas in AEI Management

Summary: Habitat alteration is not restricted in developed areas unless it impacts undeveloped core areas of an AEI (e.g., noise and light impacts on a core area). Current ongoing disturbance activities are not restricted in developed areas. Disturbance activities not currently ongoing are

restricted when impacts occur to undeveloped core areas of an AEI that are occupied by a threatened or endangered species.

Developed areas include all building structures, paved roads, improved gravel roads, paved and unpaved parking lots, and firing sites. The extent of developed areas in each AEI was determined using two methods. First, LANL geographic information system (GIS) analysts placed a 15 m (49 ft) border around all buildings and parking lots. For paved and improved gravel roads, the developed area was defined as the area to a roadside fence, if one exists within 9 m (30 ft) of the road, or 5 m (15 ft) on each side of the road, if there is no fence within 9 m (30 ft). If an area of highly fragmented habitat was enclosed by roads, a security fence, or connected buildings, that area was also classified as developed. Developed areas at firing sites were defined as a circle with a 91-m (300-ft) radius from the most centrally located firing pad. Second, LANL GIS analysts overlaid scanned orthophotos onto a map of the Los Alamos area and digitized all areas that appeared developed. These two information sources were overlaid and combined, so that areas classified as developed by either method were considered developed in final maps and analyses. Some areas were confirmed by ground surveys, such as the firing sites. Developed areas are contained in the HMP GIS database.

Developed areas are located in the core and/or buffer of some AEIs. However, developed areas do not constitute suitable habitat for federally listed species. Current ongoing activities in developed areas constitute a baseline condition for the AEIs and are not restricted. New activities including further development within already existing developed areas are not restricted unless they impact undeveloped portions of an AEI core. For example, if light or noise from a new office building in a developed area were to raise levels in an undeveloped core area, those light and noise levels would be subject to the guidelines on habitat alterations. If a proposed action within a developed area does not meet site plan guidelines, it must be individually reviewed for compliance with the Endangered Species Act of 1973 (ESA).

Building a new structure or clearing land within a previously designated developed area in an AEI core does not add to the size of the developed area. New structures in core areas will not be given any developed-area border unless they are individually reviewed for ESA compliance.

Development occurring in the developed area in an AEI buffer can be given a 15 m (49 ft) developed-area border at the discretion of the project leader or facility manager. To expand the size of a developed area in a buffer based on new developments, please contact a LANL biological resources subject matter expert (SME) (<http://int.lanl.gov/environment/bio/controls/index.shtml>).

3.2 General Description of Buffer Areas and Allowable Buffer Area Development

Summary: Limited future development is allowed in the currently undeveloped DOE-controlled buffer area under the guidelines of this HMP as long as it does not alter habitat in the undeveloped AEI core (including light and noise guidelines). Development beyond the cap established for each AEI, or greater than 2 ha (5 ac) in size including the developed-area border, requires independent review for ESA compliance.

The purpose of buffer areas is to protect core areas from undue disturbance or habitat degradation. The current levels of development in buffer and core areas represent baseline conditions for this

HMP. No further development is allowed in the core area under the guidelines of this HMP. A limited amount of development is allowed in buffer areas. Under the guidelines of this HMP, individual development projects are limited to 2 ha (5 ac) in size, including a 15 m (49 ft) developed-area border around structures and a 5 m (15 ft) developed-area border around paved and improved gravel roads. Projects greater than 2 ha (5 ac) in area require individual review for ESA compliance (see exceptions for fuels management activities and utility corridor maintenance). New development projects in AEI buffer areas must be reported to LANL biological resources SMEs for tracking (<http://int.lanl.gov/environment/bio/controls/index.shtml>). Descriptions of each of the AEIs give the total area in each buffer area available for development.

3.3 Emergency Actions

Summary: Contact DOE and LANL biological resources SMEs as soon as possible.

If safety and/or property is immediately threatened by something occurring within an AEI (for example, wildfire, water line breakage, etc.) managers may activate emergency actions. Contact a LANL biological resources SME (<http://int.lanl.gov/environment/bio/controls/index.shtml>), the Environmental Stewardship Group (1-505-665-8855), or the DOE Los Alamos Field Office (Field Office; 1-505-667-6819) as soon as possible. If the emergency occurs outside of regular business hours, contact the Emergency Management Office (1-505-667-6211). This office will then communicate with the appropriate LANL and DOE Field Office personnel.

4.0 IMPLEMENTATION OF SITE PLANS

4.1 Roles and Responsibilities

Summary: LANL's facility managers and operational staff are responsible for ensuring that activities are reviewed for compliance with all applicable site plans. Figure 1 illustrates the process for utilizing site plans. If activities follow approved guidance, there is no requirement for additional ESA regulatory compliance. However, additional National Environmental Policy Act (NEPA), cultural resources, wetlands, or other regulatory compliance actions may be required.

If an activity or project occurs outside of all LANL AEIs and will not impact habitat within an AEI, it does not have to be reviewed for ESA compliance, unless it is a large project. Projects that are larger than 2 ha (5 ac) or cost more than \$5 million require an individual ESA compliance review, even if they are not located within an AEI.

LANL's facility managers are responsible for determining if operations within their geographic and/or programmatic area of responsibility comply with the guidelines in these site plans. Submission of a Permits and Requirements Identification (PR-ID) for a new or modified project is required under Program Description 400 (LANL 2013) and allows managers to identify the requirements within their project area. Deployed environmental professionals and core LANL biological resources SMEs are available to support facility managers. If activities follow site plan guidelines, they do not require any additional ESA regulatory compliance action. However, NEPA, cultural resources, wetlands, or other regulatory compliance actions are not addressed in site plans and additional compliance actions may be required. It is the responsibility of the project leader or facility management staff to ensure that all requirements are satisfied. If you have

questions, contact biological, cultural, NEPA, or other environmental SMEs. Contacts can be found at <http://int.lanl.gov/environment/compliance/ier/index.shtml>.

A single facility may have one or more AEIs within its boundary and the AEIs may be for different species. Some AEIs overlap. In areas where overlap occurs, project managers must follow the guidelines for AEIs of all involved species.

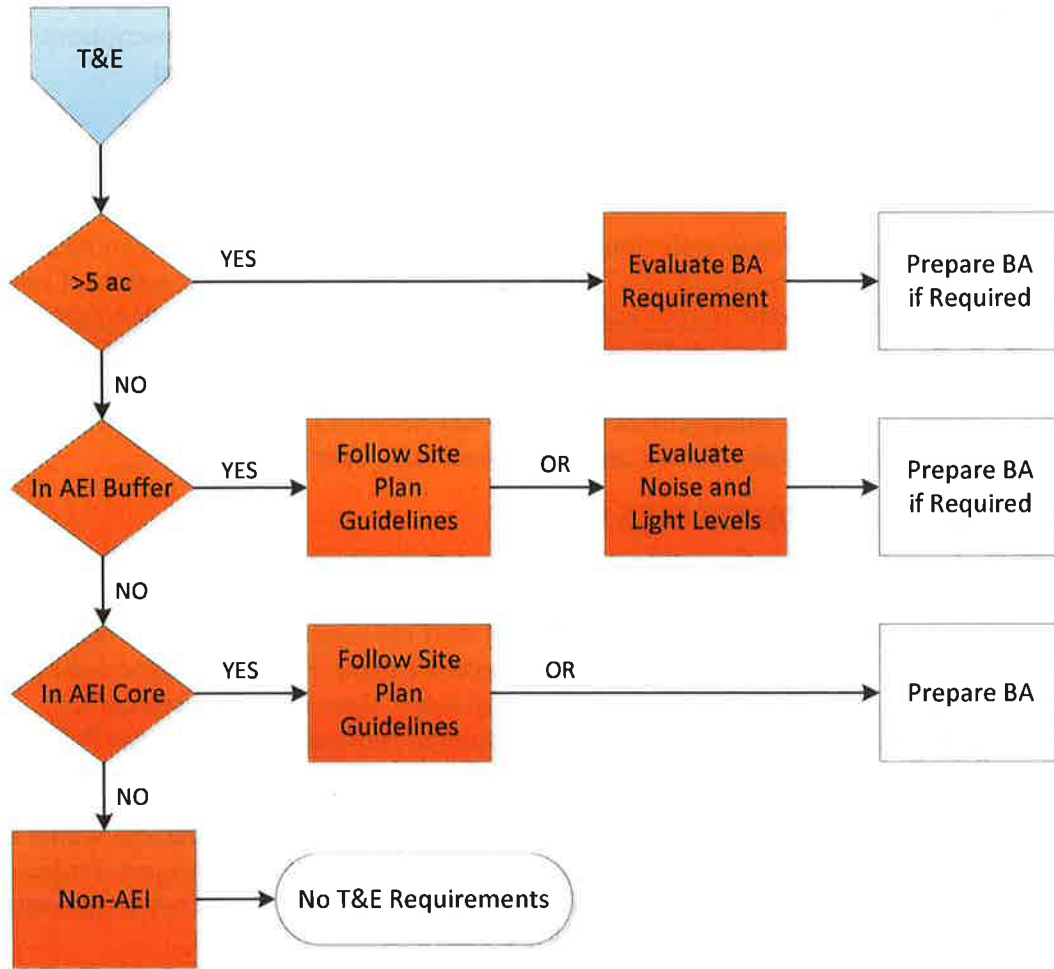

Figure 1. Process flowchart for determining site plan requirements.

4.2 If an Activity Does Not Meet Site Plan Guidelines

Summary: Activities or projects that do not meet all applicable site plan guidelines must be evaluated individually for compliance with the ESA.

If a project reviewer determines that an activity or project cannot meet the guidelines in applicable site plans, LANL biological resources SMEs evaluate that activity individually for compliance with the ESA. Results of the evaluation of potential impacts allow LANL biological resources SMEs to make recommendations to the DOE Field Office Biological Resources Program Manager

regarding the need for USFWS consultation. An evaluation may result in 1) a DOE Field Office determination that there is no possibility of adverse effects and the activity can proceed, 2) a DOE Field Office suggestion for modifications of the action to avoid adverse effects so that it can proceed, or 3) a DOE Field Office decision to prepare a biological assessment (BA) for the activity and submit it to the USFWS for concurrence. Fieldwork and preparation of a BA can take a few months with an additional 2 to 12 months for DOE Field Office review and then final USFWS concurrence.

4.3 Dissemination of Information

Although information about threatened and endangered species is not classified, it is considered sensitive information. It is in the best interest of threatened and endangered species to restrict specific knowledge about their locations. Habitat locations of threatened and endangered species are not considered sensitive.

5.0 CHANGES IN THE HMP SINCE IMPLEMENTATION

The HMP received concurrence from USFWS and was first implemented in 1999. Since that time, both the Peregrine Falcon (*Falco peregrinus*) and the Bald Eagle (*Haliaeetus leucocephalus*) have been delisted. Site plans for those species have been removed from LANL's HMP. Both species are protected at LANL under the Migratory Bird Treaty Act, and the Bald Eagle is also protected under the Bald and Golden Eagle Protection Act.

The black-footed ferret (*Mustela nigripes*) is federally listed as endangered. However, no sightings of black-footed ferrets have been reported in Los Alamos County for more than 50 years. In addition, no large prairie dog towns, which are prime habitat for black-footed ferrets, have been observed on DOE property around LANL. Therefore, there is no site plan for this species.

In 2005, the USFWS concurred with DOE's proposal for new Mexican Spotted Owl habitat boundaries based on a revised analysis of Mexican Spotted Owl habitat quality within DOE property around LANL (USFWS consultation number 22420-2006-I-0010).

In 2012, the USFWS concurred with DOE's proposal to modify the habitat boundaries for the Los Alamos Canyon Mexican Spotted Owl AEI due to changes from the fire response activities after the Las Conchas wildfire (USFWS consultation number 02ENNM00-2012-IE-0088).

In 2013, the USFWS concurred with the DOE's new site plan for the Jemez Mountains salamander and its addition to LANL's HMP (USFWS consultation number 02ENNM00-2014-I-0014).

6.0 DATA MANAGEMENT

The data used in the implementation of the HMP is stored in a GIS database at LANL.

II. AREA OF ENVIRONMENTAL INTEREST SITE PLAN FOR THE MEXICAN SPOTTED OWL

1.0 SPECIES DESCRIPTION—MEXICAN SPOTTED OWL

1.1 Status

In 1993, the USFWS determined the Mexican Spotted Owl to be a threatened species under the authority of the ESA, as amended (58 Federal Register [FR] 14248). In 1995, the USFWS released its final recovery plan for the owl (USFWS 1995), which was revised in 2012 (USFWS 2012). The USFWS most recently designated critical habitat for Mexican Spotted Owl in 2004 (69 FR 53181).

1.2 General Biology

The Mexican Spotted Owl is found in northern Arizona, southeastern Utah, and southwestern Colorado south through New Mexico, west Texas, and into Mexico. It is the only subspecies of Spotted Owl recognized in New Mexico (USFWS 1995).

The Mexican Spotted Owl generally inhabits mixed conifer and ponderosa pine (*Pinus ponderosa*; Lawson & C. Lawson) - Gambel oak (*Quercus gambelli*; Nutt.) forests in mountains and canyons. High canopy closure, high stand diversity, multilayered canopy resulting from an uneven-aged stand, large, mature trees, downed logs, snags, and stand decadence as indicated by the presence of mistletoe are characteristic of Mexican Spotted Owl habitat. Some owls have been found in second-growth forests (i.e., younger forests that have been logged); however, these areas were found to contain characteristics typical of old-growth forests. Mexican Spotted Owls in the Jemez Mountains seem to prefer cliff faces in canyons for their nest sites (Johnson and Johnson 1985). The recovery plan for the Mexican Spotted Owl recommends that mixed conifer and pine-oak woodland types on slopes greater than 40 percent be protected for the conservation of this owl.

A mated pair of adult Spotted Owls may use the same home range and general nesting areas throughout their lives. A pair of owls requires approximately 800 ha (1,976 ac) of suitable nesting and foraging habitat to ensure reproductive success. Incubation is carried out by the female. The incubation period is approximately 30 days, and most eggs hatch by the end of May. Most owlets fledge in June, 34 to 36 days after hatching (USFWS 1995). The owlets are “semi-independent” by late August or early September, although juvenile begging calls have been heard as late as September 30. Young are fully independent by early October. The non-breeding season runs from September 1 through February 28. Although seasonal movements vary among owls, most adults remain within their summer home ranges throughout the year.

The diet of Mexican Spotted Owls nesting in canyons consists primarily of woodrats (*Neotoma* spp.) and mice (*Peromyscus* spp.) with lesser amounts of rabbits, birds, reptiles, and arthropods (Willey 2013). The relative abundance of prey types in Mexican Spotted Owl pellets collected at LANL are listed in Table A-1 in the Appendix. Ganey and Balda (1994) found core areas of individuals (i.e., where owls spent 60 percent of their time) averaged 134 ha (331 ac), and core areas for pairs averaged 160 ha (395 ac).

1.3 Threats

The Mexican Spotted Owl was listed as threatened because of destruction and modification of habitat caused by timber harvest and fires, increased predation on owls associated with habitat fragmentation, and a lack of adequate protective regulations.

2.0 IMPACT OF HUMAN ACTIVITIES

2.1 Introduction

The primary threats to Mexican Spotted Owls on DOE property around LANL property are 1) impacts to habitat quality from LANL operations and 2) disturbance of nesting owls. This section provides a review and summary of scientific knowledge of the effects of various types of human activities on the Mexican Spotted Owl and provides an overview of the current levels of activities at LANL.

2.2 Impacts on Habitat Quality

2.2.1 Development

The type of habitat used by Mexican Spotted Owls, late seral stage forests with large trees, are usually not found in large quantities near developed areas or near areas that have had recent agricultural or forest product extraction land uses. Therefore, Mexican Spotted Owls are generally not found near developments. Whether it is the development itself or a lack of suitable habitat that discourages colonization of these areas by Mexican Spotted Owls is unknown.

Areas of LANL vary from remote undeveloped areas to heavily developed and/or industrialized facilities. Most LANL facilities are situated atop mesas, primarily in the northern and western portion of the DOE property. LANL is bounded by developed residential, industrial, and retail areas along its northern boundary (the town of Los Alamos) and by residential and retail development along a portion of its eastern boundary (the town of White Rock). Three major paved roads traverse LANL from northeast to southwest. Sandia, Pajarito, and Los Alamos canyons have paved roads within AEIs, and several AEIs have dirt roads along at least a portion of the canyon bottom. AEIs containing paved or dirt roads in the canyon bottoms have not been occupied at LANL (Hathcock et al. 2010).

2.2.2 Ecological Risk

There is no specific information on the impact of chemicals on the Mexican Spotted Owl, although experience with other raptor species suggests that exposure to polychlorinated biphenyls (PCBs), dichloro-diphenyl-trichloroethane (DDT) and its derivatives, and other organophosphate or organochlorine pesticides would probably be harmful. Exposure to other chemicals could also be harmful (Cain 1988).

LANL completed three ecological risk assessments that included the Mexican Spotted Owl between 1997 and 2009. The ecological risk assessment process involves using computer modeling to assess potential effects to animals from chemicals of potential concern (COPCs) that have been detected in the environment. All of the following ecological risk assessments concluded that, on average, no appreciable impact is expected to Mexican Spotted Owls from COPCs (Gallegos et al. 1997; Gonzales et al. 2004; Gonzales et al. 2009).

2.2.3 Disturbance

2.2.3.1 Pedestrians and Vehicles

Based on work with other raptors, LANL biological resources SMEs assume that Mexican Spotted Owls would likely be disturbed by the approach of either pedestrians or vehicles. At an equal distance, pedestrians are frequently more disturbing to raptors than vehicles (Grubb and King 1991). Brown and Stevens (1997) reported that during surveys in Grand Canyon National Park, 22 times more Bald Eagles were found in canyon reaches with low human recreational use compared to reaches with moderate to high human recreational use. Human activity 100 m (328 ft) from Bald Eagle nests in Alaska caused clear and consistent changes in behavior of breeding eagles (Steidl and Anthony 2000).

Swarthout and Steidl (2001) found that both juvenile and adult roosting Mexican Spotted Owls were unlikely to alter their behavior in the presence of a single hiker at distances greater than 55 m (180 ft). Swarthout and Steidl (2003) concluded that cumulative effects of high levels of short-duration recreational hiking near Mexican Spotted Owl nests may be detrimental.

Many canyon bottoms and mesa tops at LANL have dirt roads traversing them. Most of these roads are gated. However, these roads are accessible to LANL employees and some of them are accessible to the public on foot or by bike. LANL biological resources SMEs have found that AEIs are occupied less often if there is recreational access into a canyon (Hathcock et al. 2010).

2.2.3.2 Aircraft

Ground-based disturbances appear to impact raptor reproductive success more than aerial disturbances (Grubb and King 1991). Grubb and Bowerman (1997) concluded that an exclusion of aircraft within 600 m (1,968 ft) of Bald Eagle nest sites would limit Bald Eagle response frequency to 19 percent.

Delaney et al. (1999) found for Mexican Spotted Owls that chainsaws consistently elicited higher response rates than helicopters at similar distances. Owl flush rates did not differ between nesting and non-nesting seasons. No owls flushed when noise stimuli (helicopter or chainsaws) were at distances greater than 105 m (344 ft). Distance was generally a better predictor of owl response to helicopter overflights than sound level.

LANL is restricted airspace, and planes infrequently fly less than 609 m (2,000 ft) above ground level. The County of Los Alamos operates an airport along the northern edge of LANL. The airport is located on the southern rim of Pueblo Canyon. Most flights approach and depart to the east of the airport, over the Rio Grande.

2.2.3.3 Explosives

There is no specific information on the reaction of Mexican Spotted Owls to explosives detonation currently available. Explosive blasts set off 120 to 140 m (393 to 459 ft) from active Prairie Falcon (*Falco mexicanus*) nests caused perched Prairie Falcons to flush from perches 79 percent of the time, and, in 26 percent of the cases, caused incubating Prairie Falcons to flush from nests. Measured sound levels at aerie entrances during blasts ranged from 129 to 141 decibel (dB) (Holthuijzen et al. 1990). Explosives blasting for dam construction 560 to 1,000 m (1,837 to 3,280 ft) from active Prairie Falcon nests caused a change in behavior 26 percent of the time, and

birds flushed in 17 percent of all cases. No incubating birds flushed (Holthuijzen et al. 1990). Brown et al. (1999) found little activity change in roosting or nesting Bald Eagles and no population-level impacts from weapons detonations at the Aberdeen Proving Ground. Holthuijzen et al. (1990) found that a 167-g (5.89-oz) charge of Kinestik produced noise levels between 138 and 141 dB at 100 m (328 ft), and that a 500-g (17.6-oz) charge of TNT produced noise levels between 144 and 146 dB at 100 m (328 ft). A 20-kg (44-lb) charge of TNT produced noise levels that measured 163 dB at 100 m (328 ft) (Paakkonen 1991).

Measurements of noise levels during explosives testing were conducted at three locations at LANL using quantities of high explosives ranging from 4.5 to 67.5 kg (10 to 148 lb) of TNT during six shots. Noise levels increased during the test from a background level of 31 dB(A)¹ to a range between 64 and 71 dB(A) during shots at a distance of 1.8 km (1.1 mi). At a distance of 4.3 km (2.67 mi), noise levels rose from a background range of 35 to 64 dB(A) to a range of 60 to 63 dB(A) (Vigil 1995). At a distance of 6.7 km (4.16 mi), noise levels rose from a background range of 38 to 51 dB(A) to a range of 60 to 71 dB(A) (Burns 1995). LANL biological resources SMEs estimated that the noise from a shot at the Dual-Axis Radiographic Hydrodynamic Test (DARHT) Facility would be 150 dB(A) at the source and 80 dB(A) at 400 m (1,312 ft) (Keller and Risberg 1995). LANL biological resources SMEs found that Mexican Spotted Owl AEIs located within the explosives testing buffer area were occupied more frequently than AEIs in other locations (Hathcock et al. 2010). This is likely due to the strict access control in explosives areas which limit human activity and development in the canyon bottoms.

2.2.3.4 Other Sources of Noise

Major noise-producing activities at LANL include automobile and truck traffic and noise associated with office buildings, construction activities, a live-fire range, and explosives testing. Also, there is noise associated with aircraft traffic at the Los Alamos County airport. Construction and maintenance activities involved with operations at LANL are fairly common. In addition, implementation of the 2005 Compliance Order on Consent (NMED 2005) issued by the New Mexico Environmental Department (NMED) has resulted in an increased frequency of drilling groundwater monitoring wells in protected habitat at LANL. Also, forest fuels management operations use chainsaws, chippers, and other noise-generating equipment. The 2010 National Pollutant Discharge Elimination System (NPDES) Individual Permit (EPA 2010) issued by the Environmental Protection Agency (EPA) requires sediment control features such as berms and small rock check dams to be installed at various sites with stormwater runoff; these are sometimes installed in protected habitat. LANL biological resources SMEs conducted a study of noise levels in canyons and found that the primary sources of noise exceeding 55 dB(A) were cars and trucks. Readings taken near flowing water were up to 11 dB(A) higher than readings taken elsewhere. The average dB(A) in canyons near paved roads ranged from 41 to 62, with maximum values ranging from 62 to 74. Away from paved roads 1.6 km (1 mi) or more, average dB(A) in canyons ranged from 37 to 50, with all but one average below 45. Maximum dB(A) away from paved roads ranged from 38 to 76 [76 dB(A) was measured during a thunder clap] (Huchton et al. 1997).

¹ Sound can be measured as decibels (dB), C-weighted dB [dB(C)], or A-weighted dB [dB(A)]. The dB(A) measurement best resembles the response of the human ear by filtering out lower and higher frequency sound not normally heard by the human ear.

Noise measurements were conducted by LANL biological resources SMEs at the Los Alamos County airport and in Bayo and Pueblo canyons, including the Los Alamos County Sewage Treatment Facility, in December 1997. Sound levels near the airport runway during the maximum use time (6:30 to 7:30 am) had background values averaging 54 dB(A). Noise during plane arrivals ranged from 47 to 63 dB(A). No measurements were collected during plane take-off. Sound measurements conducted in the bottoms of Pueblo and Bayo canyons ranged from 37 to 40 dB(A) in most areas of the canyon. At the sewage treatment facility parking lot during a working day, the average dB(A) during a three-minute period was 46 (range 45 to 49). At the intersection of the road going into Pueblo Canyon with State Road 502, the average dB(A) during a three-minute period was 60 (range 41 to 70).

LANL biological resources SMEs conducted sound measurements at successive distances from an industrial area near a canyon rim, into the canyon, and to the opposite rim, using a C-weighted decibel scale (Keller and Foxx 1997). Measurements of noise levels using the C-weighted decibel scale are greater than if measured using A-weighted decibels. The average background noise on the mesa was 65.8 dB(C) [with a range of 43–81 dB(C)]. The average background noise in the canyon bottom was 62.3 dB(C) [with a range of 54–78 dB(C)]. The average background noise at the bottom of the north-facing slope was 53.8 dB(C) [with a range of 48–64 dB(C)]. Measurements were taken mid-day.

LANL biological resources SMEs measured sound levels from various pieces of construction equipment used at project sites at LANL over 5-minute intervals at distances of 6 to 31 m (20 to 100 ft) (Knight and Vrooman 1999). Average values ranged from 58.5 dB(A) to 80.9 dB(A). Peak values ranged from 75.7 to 155.4 dB(A). Additional data were collected by other LANL operators on specific pieces of construction equipment and on the Security Computer Complex construction site fence perimeter at Technical Area 3 before and during construction (Knight and Vrooman 1999). The average noise levels before construction began was 56.6 dB(A), and the average during construction was 82.1 dB(A).

LANL biological resources SMEs conducted a series of sound measurements at LANL to investigate background noise levels around AEIs (Vrooman et al. 2000). Background noise levels were significantly higher in daytime than in nighttime. AEIs with greater than 10 percent developed area in their buffers had significantly higher levels of background noise than undeveloped AEIs. Mean background sound levels were 51.3 dB(A) in developed AEIs and 39.6 dB(A) in undeveloped AEIs. The LANL biological resources project review process uses the individual AEI background measurements from Vrooman et al. (2000) to screen project activities for increases more than 6 dB(A) above background.

LANL biological resources SMEs took sound level measurements of heavy equipment use associated with concrete recycling on Sigma Mesa at LANL in 2004 (Hansen 2004). At this location, background noise levels at two different locations were 55.2 and 58.8 dB(A). Operation of a dump truck hauling and dumping concrete increased noise levels above background by a mean of 22.7 dB(A) at 30 m (98 ft) and 2.4 dB(A) at 80 m (262 ft). Additional sound level measurements were taken in the same general area on Sigma Mesa in 2005 as part of a BA for the operation of an asphalt batch plant (Hansen 2005). Measurements were taken on the north rim of Mortandad Canyon (south of the asphalt batch plant at distances of approximately 30 to 122 m (100 to 400 ft), at the bottom of Mortandad Canyon, approximately 183 to 244 m (600 to 800 ft) from the asphalt

batch plant, and on the south rim of Mortandad Canyon approximately 305 m (1,000 ft) from the asphalt batch plant. Background noise levels at the various locations ranged from 41.1 to 48.7 dB(A). The only locations with increases greater than 3 dB(A) during operation of the asphalt batch plant were the locations on the north rim of Mortandad Canyon, within 122 m (400 ft) of the asphalt batch plant. Noise from the operation of the asphalt batch plant was not detected in the bottom of Mortandad Canyon or on the south rim.

LANL biological resources SMEs took sound level measurements around the LANL Biosafety Level 3 (BSL-3) Laboratory with the heating, ventilation, and air conditioning (HVAC) system on and with it off (Hansen 2009). The area to the north of the BSL-3 is developed, the area to the south is not. Background noise levels north of the facility ranged from 53.6 to 57.6 dB(A). Background noise levels south of the facility ranged from 41.6 to 49.7 dB(A). Noise from the HVAC system was detected at 25 m (82 ft) from the facility on both sides, but was not detected at 81 m (266 ft) on the north side, or at 107 m (351 ft) on the south side.

Overall, these studies appear to show that areas adjacent to or within developed areas or paved roads are likely to have daytime average background noise levels between 45 and 63 dB(A). Less disturbed areas are likely to have average background noise levels between 37 and 50 dB(A).

2.2.3.5 Artificially Produced Light

There is no information available on the effects of artificially produced light on Mexican Spotted Owls. Under the Los Alamos County Code, commercial site development plans are reviewed to ensure that lighting serves the intended use of the site while minimizing adverse impacts to adjacent residential property (Section 16-276). Section 16-276 of the County Code includes light source measurement limitations by zoning district. The code allows off-site light to be 0.5 foot candles (fc) in residential areas. By comparison, full moonlight measures 0.1 fc, and a crescent moon was measured at 0.01 fc. Table A-2 in the Appendix presents preliminary light measurements in fc.

Preliminary surveys were conducted for light levels within Los Alamos Canyon at the Omega Reactor (Keller and Foxx 1997). The Omega Reactor was brightly lit for purposes of security; therefore, total light intensity was greater than the average street lighting. Measurements were conducted at a light pole with an open parking lot at the reactor as the source. Trees did not obscure the area. Using the relationship of light intensity reducing as a square of the distance, calculations using the field data indicated that at 30 m (98 ft) from the source the light levels would be equivalent or nearly equivalent to full moonlight.

3.0 AEI GENERAL DESCRIPTION FOR MEXICAN SPOTTED OWL

An AEI consists of two areas—a core and a buffer. The core of the habitat is defined as suitable canyon habitat from rim to rim and 100 m (328 ft) out from the top of the canyon rim. The buffer area is 400 m (1,312 ft) wide extending outward from the edge of the core area. Although adult Mexican Spotted Owls may be found within their home range anytime throughout the year, the primary threat from disturbance to the owls is during the breeding season when owl pairs are tied to their nest sites. Therefore, management of disturbance in Mexican Spotted Owl AEIs is concentrated on the breeding season.

3.1 Method for Identifying a Mexican Spotted Owl AEI

The original location of each Mexican Spotted Owl AEI was identified using a habitat model developed by Johnson (1998) that classified nesting and roosting habitat for Mexican Spotted Owls using topographic characteristics and vegetative diversity. LANL biological resources SMEs compared the results from the Johnson (1998) model to a different model identifying slopes >40 percent in mixed conifer and ponderosa pine cover types at LANL. Areas identified from the Johnson (1998) model application to LANL that were over five contiguous 30 × 30 m (97 × 98 ft) pixels in size, were above 1,980 m (6,496 ft) in elevation, and that had mixed conifer or ponderosa pine forest cover, were considered suitable Mexican Spotted Owl habitat. Where suitable habitat was identified, AEI core area boundaries were established to include the canyons and 100 m (328 ft) outward from the canyon rims.

A new Mexican Spotted Owl habitat model was developed and refined for application on LANL following the Cerro Grande wildfire (Hathcock and Haarmann 2008). This model incorporated finer-scale vegetation characteristics into the Mexican Spotted Owl habitat quality assessment. This model was used to redelineate the boundaries of the Mexican Spotted Owl AEIs at LANL in 2005 following wildfire, drought, and a regional bark beetle outbreak (USFWS consultation number 22420-2006-I-0010).

The new core boundaries were delineated with an area approximately 0.4 km (0.25 mi) from the edge of the nearest suitable habitat, up and down canyon. Core boundaries were established along readily recognizable geologic features or anthropogenic features in the terrain wherever possible to facilitate the ease of identification of core boundaries when in the field.

3.2 Location and Number of Mexican Spotted Owl AEIs

There are currently five Mexican Spotted Owl AEIs on LANL, each encompassing one or more canyons. In general, the AEI cores are centered in canyons on the western side of LANL. The canyons with AEIs are Cañon de Valle, Water, Pajarito, Los Alamos, Sandia, Mortandad, and Three-Mile. AEI boundaries are maintained in the LANL biological resources program GIS database.

4.0 AEI MANAGEMENT

4.1 Overview

This AEI management section provides guidelines for LANL operations to reduce or eliminate the threats to Mexican Spotted Owls from 1) habitat alterations that reduce habitat quality and 2) disturbance of breeding or potentially breeding owls. Habitat alterations are considered for all AEIs and for both core and buffer areas. Disturbance activities to owls are considered only for occupied AEIs and only for impacts on core areas. Developed areas (see Part I, Section 3.1) that have ongoing baseline levels of activities and are not suitable habitat for Mexican Spotted Owls have different restrictions than undeveloped core or buffer areas. Therefore, the location of the disturbance activity within the AEI, the occupancy status of the AEI, and the type of activity all affect whether or not the activity is allowable. AEIs for different species may overlap, and an activity must meet the guidelines of all applicable site plans to be allowable.

4.2 Definition and Role of Occupancy in AEI Management

Summary: The occupancy status of an AEI affects what disturbance activities are allowable in different areas (core, buffer, developed) of the AEI. All Mexican Spotted Owl AEIs are considered occupied during March 1 through August 31 or until surveys show the AEI to be unoccupied. See the Activity Table (Table 1, Section 4.5.2) for restrictions on occupied undeveloped core and buffer areas, and Part I, Section 3.1 for restrictions on developed areas.

Occupancy simply refers to whether or not an AEI is occupied during a species' period of sensitivity. For Mexican Spotted Owls, LANL is primarily concerned with protecting the owls from disturbance during the breeding season. Because individuals may colonize suitable habitat, all Mexican Spotted Owl AEIs are treated as though they are occupied from March 1 through August 31 or until surveys show an AEI to be unoccupied. Mexican Spotted Owl surveys are conducted from late March through June. In general, surveys in areas with ongoing or proposed projects are completed by May 15. If a nest is located during surveys, then the AEI can be treated as unoccupied except for the area within a 400 m (1,312 ft) radius of the nest site. Because owls are not as sensitive to disturbance during the non-breeding season, Mexican Spotted Owl AEIs are treated as unoccupied from September 1 to February 28.

The occupancy status of an AEI affects what activities are allowable in the AEI. Although activities causing habitat alterations are restricted in all AEIs, disturbance activities are restricted only in occupied AEIs. The Activity Table (Table 1, Section 4.5.2) provides dates and levels of allowable disturbance activities within occupied Mexican Spotted Owl AEIs under the guidelines of this site plan. Contact a LANL biological resources SME to find out the current occupancy status of an AEI (<http://int.lanl.gov/environment/bio/controls/index.shtml>).

4.3 Introduction to AEI Management Guidelines

Summary: The habitat alterations section and the activities section give the guidelines for habitat alteration and disturbance activities, respectively, for Mexican Spotted Owl AEIs. The flow chart (see Figure 1) provides a quick reference to determine what, if any, guidelines need to be consulted for a specific activity. Protective measures give management practices that should be applied when working or considering work in AEIs. LANL biological resources SMEs are available to answer questions and provide advice (<http://int.lanl.gov/environment/bio/controls/index.shtml>).

Sections 4.4 and 4.5 provide the guidelines for habitat alterations and allowable activities in AEI core and buffer areas. Section 4.4 describes what and where habitat alterations are allowed under the guidelines of this site plan. Section 4.5 describes what, when, and where disturbance activities are allowed in occupied AEIs under the guidelines of this site plan. If an activity does not meet the restrictions given in the guidelines, the activity must be individually reviewed for ESA compliance. This site plan only provides guidelines for Mexican Spotted Owl AEIs. If an activity is desired in an area with overlapping AEIs, all applicable site plans must be consulted. AEI maps show the location of all AEIs in an area. Section 4.6 describes management practices that should be applied when working or considering work in an AEI. LANL biological resources SMEs are available to answer questions and provide advice (<http://int.lanl.gov/environment/bio/controls/index.shtml>).

4.4 Definition of and Restrictions on Habitat Alterations

4.4.1 Definition of Habitat Alterations

Habitat alteration includes any action that alters the soil structure, vegetative components necessary to the species, prey quality and quantity, water quality, hydrology, or noise or light levels in undeveloped areas of an AEI. Long-term means the alteration lasts for more than one year. For physical disturbances, in general, any activity that can be accomplished by one person with a hand tool is generally not considered habitat alteration; any activity that requires mechanized equipment on a landscape is habitat alteration. An actual activity may take place outside of the AEI and will be considered habitat alteration if consequences of the activity have effects inside the AEI core.

The habitat components most important to Mexican Spotted Owls include vegetative structure, food quality and quantity, and disturbance levels, including noise and light. The forest structure within a canyon designated as a Mexican Spotted Owl AEI is important because it provides roost sites and a suitable habitat for nesting and foraging. Trees along the canyon rim are used for foraging and territorial calling, and they shelter the canyon interior from light and noise disturbances.

A long-term change in light or noise levels within the undeveloped core of an AEI is considered to be a habitat alteration if it increases average noise levels by ≥ 6 dB(A) during any portion of the 24-hour day, or it increases average light levels by ≥ 0.05 fc at night. Changes in noise and light levels are measured at the core area boundary if the source is outside the core area, or at 10 m (33 ft) from the source if the source is inside the undeveloped core area. Impacts of changes in developed areas on undeveloped cores are measured at the developed area boundary if it is within the core, or at the core area boundary if the developed area is outside of the core.

4.4.2 Fuels Management Practices to Reduce Wildfire Risk

The recovery plan for the Mexican Spotted Owl lists stand-replacing wildfires as a primary threat to their habitat and encourages land managers to reduce fuel levels and abate fire risks in ways compatible with owl presence on the landscape (USFWS 1995). Within undeveloped core areas, on slopes >40 percent, in the bottoms of steep canyons, and within 30 m (100 ft) of a canyon rim, thinning of trees <22 cm (9 in) diameter at breast height, treatment of fuels, and prescribed and natural prescribed fires are allowed. Exceptions allowing trees >22 cm (9 in) to be thinned within 30 m (100 ft) of buildings are granted to protect facilities. Large logs (>30 cm [11.8 in] midpoint diameter) and snags should be retained. Thinning within core areas not meeting the characteristics listed above, and in buffer areas, may include trees of any size to achieve 8 m (25 ft) spacing between tree crowns. However, clear cutting is not allowed in undeveloped core areas.

For health and safety reasons, any trees within 30 m (100 ft) of buildings, but outside a developed area, may be thinned to achieve 8 m (25 ft) spacing between crowns. Habitat alterations including thinning are not restricted in developed areas. However, LANL biological resources SMEs encourage the retention of trees and snags along canyon rims if the rim is in a developed area. Because of the extreme fire danger associated with firing sites and the potential impact of a fire on Mexican Spotted Owl habitat, firing sites and burn areas are treated separately for the purposes of fuels management. Trees within 380 m (1,246 ft) of firing sites and burn areas in both core and

buffer areas may be thinned to a 15 m (49 ft) spacing between trees everywhere except on slopes >40 percent or in the bottoms of steep canyons. Any tree over 22 cm (9 in) diameter at breast height within 380 m (1,246 ft) of a firing site may be delimited to a height of 2 m (6 ft) to help prevent crown fires.

In historically occupied core areas, fuels treatment may not exceed 10 percent of the undeveloped core area and is not allowed within 400 m (1,312 ft) of nesting areas. In occupied core areas, forest management activities must take place during the nonbreeding season (September 1 to February 28) (USFWS 1995). Fuels management activities that are allowable in core areas have to be reported to LANL biological resources SMEs for tracking.

4.4.3 Utility Corridors

Habitat alterations such as cutting down trees that threaten power lines are allowed within 8 m (26 ft) of either side of an existing utility line in all areas of an AEI (Trujillo and Racinez 1995). New utility lines and utility lines requiring clearance of a right-of-way greater than 16 m (52 ft) total must be individually reviewed for ESA compliance. Disturbance activities must follow the guidelines given in the Activities Table (Table 1, Section 4.5.2) for occupied AEIs.

4.4.4 Restrictions on Habitat Alterations

Summary: Habitat alterations other than fuels management practices and utility corridor maintenance are not allowed in undeveloped core areas. Habitat alterations in buffer areas are restricted to 2 ha (5 ac) per project, with a maximum cap on development in the buffer for each AEI. Habitat alterations other than fuels management and utility corridor maintenance must be reported to LANL biological resources SMEs for tracking (<http://int.lanl.gov/environment/bio/controls/index.shtml>).

Habitat alterations other than the fuels management practices and utility corridor maintenance described above are not allowed in undeveloped core areas under the guidelines of this site plan. If a project or activity is planned that would alter habitat in an undeveloped core area, it must be individually evaluated for ESA compliance. Habitat alterations in undeveloped buffer areas other than the fuels management activities and utility corridor maintenance described above are restricted to 2 ha (5 ac) in area per project and are subject to other restrictions including light and noise effects in the core (see Section 2.2.3). Projects in the buffer over 2 ha (5 ac) in size will require individual ESA compliance review.

Habitat alterations in a buffer area other than the fuels management and utility corridor maintenance described above must be reported to LANL's biological resources SMEs for tracking (<http://int.lanl.gov/environment/bio/controls/index.shtml>). There is a cumulative maximum area that can be developed in each AEI's buffer. Once that cumulative area is reached, all habitat alterations in a buffer will require individual ESA reviews for compliance.

4.5 Definition of and Restrictions on Disturbance Activities

4.5.1 Definitions of Disturbance Activities

LANL biological resources SMEs considered six categories of activities that might cause disturbance in an AEI. Most of the categories were first identified in the document "Peregrine

Falcon Habitat Management in the National Forests of New Mexico,” prepared for the United States Forest Service (Johnson 1994). LANL biological resources SMEs added explosives detonation, other light production, and other noise production to provide the most comprehensive list of activities possible, thereby reducing the need for individual review of activities for ESA compliance. The categories of activities are people, vehicles, aircraft, other light production, other noise production, and explosives detonation. LANL biological resources SMEs have defined low, medium, and high levels of impact for these activities except for explosives detonation. Activity levels for explosives detonation have been designed to follow the guidelines agreed upon by LANL, DOE, and USFWS in the DARHT BA (Keller and Risberg 1995). Restrictions on explosives detonation are described in the definition of the activity, but are not included in the Activity Table (Table 1, Section 4.5.2). These six categories of activities are restricted only in AEIs that are classified as occupied.

People—includes any entry of people into an AEI on foot.

- Low impact is the presence of three or fewer people per project and duration of one day or less during a breeding season.
- Medium impact is the exceedance of either the number of people or the duration criteria.
- High impact is the exceedance of both the number of people and the duration criteria.

Vehicles—includes the entry of any two-axle highway vehicle, all-terrain vehicle, or motorized machinery into an AEI by any route other than a paved road or an improved gravel road.

- Low impact is the presence of two or fewer vehicles per project and duration of one day or less during a breeding season.
- Medium impact is the exceedance of either the number of vehicles or the duration criteria.
- High impact is the exceedance of both the number of vehicles and the duration criteria.

Aircraft—includes the operation of any aircraft below an elevation of 600 m (2,000 ft) above the highest ground level in the local vicinity.

- Low impact is the presence of one single-engine airplane and the duration of one day or less during a breeding season.
- Medium impact is the exceedance of either the number of aircraft or the duration criteria.
- High impact is the exceedance of both the number of aircraft and the duration criteria.

Any use of helicopters, jet airplanes, and propeller airplanes with two or more engines is classified as medium impact or above, depending on duration.

Other Light Production—includes any activity not previously listed that causes additional light to occur in an AEI core area. For example, plans for construction of a new building at the edge of a developed area may call for lighting at night to facilitate nighttime work that impacts an undeveloped core area.

- Low impact is the increase of light intensity by ≤ 0.05 fc and a duration of one night or less per project per breeding season.
- Medium impact is the exceedance of either the intensity or duration criteria.
- High impact is the exceedance of both the intensity and duration criteria.

Measurements for increases in light are taken at the AEI core area boundary closest to the light source if the source is outside the core and at 10 m (33 ft) from the source if the source is inside the core. Light measurements for developed areas are taken at the edge of the developed area if the developed area is within an AEI core or at the closest core boundary if the developed area is outside of an AEI core.

Other Noise Production—includes any activity not previously listed except for explosives detonation that causes additional noise to occur in an AEI. For example, operation of machinery creates noise.

- Low impact is increasing noise levels in an AEI core by 6 dB(A) or less for one day or less per project per breeding season.
- Medium impact is the exceedance of either the level or the duration criteria.
- High impact is the exceedance of both the level and the duration criteria.

Measurements for increases in noise are taken at the AEI core boundary closest to the noise source if the source is outside the core and at 10 m (33 ft) from the source if the source is inside the core. Noise measurements for developed areas are taken at the edge of the developed area if the developed area is within an AEI core or at the closest core boundary if the developed area is outside of an AEI core.

Explosives Detonation—includes the use of high explosives for any purpose. LANL biological resources SMEs did not define low, medium, and high levels of this activity because of the difficulty of determining levels for a shot before actually doing the shot. For the purpose of explosives detonation near Mexican Spotted Owl AEIs, occupied habitat is defined as the area within 400 m (1,312 ft) of the current year's nest/roost sites or the previous year's nest site if a current site has not been identified. No explosives detonation will take place within 400 m (1,312 ft) of nest/roost sites in occupied habitat between March 1 and August 31. Explosives detonation at night at sites within 400 to 800 m (1,312 to 2,624 ft) of a nest site in occupied habitat is restricted to once a month from March 1 and August 31. There are no restrictions on daytime explosives testing between 400 and 800 m (1,312 to 2,624 ft). There are no restrictions between September 1 and February 28 or in unoccupied habitat. Explosives detonation adjacent to AEIs that have not previously been recorded by LANL as occupied will have no restrictions unless surveys detect Mexican Spotted Owls. Explosives tests not allowed under the guidelines of this site plan must be individually reviewed for ESA compliance.

4.5.2 Activity Table

The dates shown in the Activity Table (Table 1) are the dates between which the activity in the row is restricted under the guidelines of this site plan. All AEIs are considered occupied from March 1 to August 31 or until surveys show an AEI to be unoccupied. If owls are detected, AEIs

are considered occupied until August 31 within 400 m (1,312 ft) of the nest site. Consult with LANL biological resources SMEs to find out occupancy status of AEIs and what locations are within 400 m (1,312 ft) of nest sites (<http://int.lanl.gov/environment/bio/controls/index.shtml>).

Table 1. Restrictions on Activities in Undeveloped Occupied Mexican Spotted Owl AEIs

	Core	Buffer
<i>People</i>		
Low	No Restrictions*	No Restrictions
Medium	March 1 to August 31	No Restrictions
High	March 1 to August 31	No Restrictions
<i>Vehicles</i>		
Low	No Restrictions	No Restrictions
Medium	March 1 to August 31	No Restrictions
High	March 1 to August 31	No Restrictions
<i>Aircraft</i>		
Low	March 1 to August 31	No Restrictions
Medium	March 1 to August 31	March 1 to May 15
High	March 1 to August 31	March 1 to August 31
<i>Other Light Production</i>		
Low	March 1 to August 31	No Restrictions**
Medium	March 1 to August 31	No Restrictions**
High	March 1 to August 31	No Restrictions**
<i>Other Noise Production</i>		
Low	March 1 to August 31	No Restrictions**
Medium	March 1 to August 31	No Restrictions**
High	March 1 to August 31	No Restrictions**
<i>Explosives Detonation (see text in Section 4.5.1)</i>		

*Entry is restricted in core areas that are occupied within 400 m (1,312 ft) of the nest site from March 1 to August 31. If the current nest has not been located, entry is restricted within 400 m (1,312 ft) of the previous year's nest site.

**Noise or light production in the buffer is restricted if the activity would violate core area restrictions on noise or light.

4.6 Protective Measures

Summary: This section provides a list of management practices to apply in Mexican Spotted Owl AEIs.

- Timing of projects must take into account that projects in core areas or projects that violate restrictions for occupied buffer areas must stop on February 28 each year until occupancy status of the AEI is determined.
- Every reasonable effort should be made to reduce the noise from explosives testing within 800 m (2,624 ft) of occupied habitat. Methods to reduce noise could include contained shots, noise shields in the direction of AEI cores, etc. For night shots, every reasonable effort should be made to limit the amount of light directed into AEI core areas.

- Put signs on dirt roads and trails leading into AEIs labeling them as restricted access areas and providing a number to contact for access restrictions.
- Keep disturbance and noise to a minimum.
- Avoid unnecessary disturbance to vegetation (e.g., excessive parking areas or equipment storage areas, off-road travel, materials storage areas, crossing of streams or washes).
- Avoid removal of vegetation along drainage systems and stream channels.
- Avoid all vegetation removals not absolutely necessary.
- Appropriate erosion and runoff controls should be employed to reduce soil loss. The controls must be put in place and periodically checked throughout the life of projects.
- All exposed soils must be revegetated as soon as feasible after construction to minimize erosion.
- In the Los Alamos Canyon AEI, development should be focused away from undeveloped areas on the western end of the AEI.

5.0 LEVELS OF DEVELOPMENT IN AEI CORE AND BUFFERS

5.1 Allowable Habitat Alteration in the Buffer Areas

The following quantifications of development and guidance for allowable habitat alteration in buffer areas were published and consulted on in the 1999 version of the HMP. Most AEIs changed in dimensions during the 2005 redelination of the habitats, and many have experienced additional development. Development in buffer habitat was not addressed during the 2005 consultation. Many projects were reviewed and received USFWS concurrence between 1999 and 2014.

LANL biological resources SMEs have provided the current development status for each of the AEIs at the end of each paragraph. The percent developed numbers were derived with the original size of the AEIs.

Cañon de Valle—In 1999, 16.3 ha (40.3 ac, 2.9 percent) of the core was developed and 52.2 ha (129 ac, 6.8 percent) of the DOE-controlled buffer was developed. For this AEI, it was recommended that only an additional 25.30 ha (62.5 ac) of the AEI buffer be developed. The 1999 HMP stated that once this cap is reached or a large-scale project is proposed, additional consultation with USFWS would be required. By 2011, 28 ha (69.2 ac) of the core and 84 ha (207.5 ac) of the buffer had been developed.

Pajarito—In 1999, there were 6.7 ha (16.5 ac, 5.5 percent) of the core developed and 75.1 ha (186.5 ac, 16.7percent) developed in the buffer. LANL biological resources SMEs recommended only an additional 35 ha (86.4 ac) of the buffer be developed before additional USFWS consultations take place. The 1999 HMP stated that once the cap is reached or a single large-scale project is proposed, additional consultation would be required. By 2011, 27 ha (66.7 ac) of the core and 89 ha (220 ac) of the buffer had been developed.

Los Alamos—In 1999, there were 77.16 ha (190 ac) of the core developed and 167.2 ha (413.1 ac) developed in the buffer. For this AEI, LANL biological resources SMEs recommended only an

additional 28.6 ha (70.6 ac, 5.9 percent) of the DOE-owned buffer be developed before additional USFWS consultations take place.

Because this AEI is so heavily developed, additional development was restricted to a few selected areas within the buffer. Development outside of these areas requires individual review for ESA compliance. A large percentage of this AEI was removed in the 2005 and 2013 BAs. By 2011, 94 ha (232.2 ac) of the core and 181 ha (447.3 ac) of the buffer had been developed.

Sandia-Mortandad—In 1999, 98.4 ha (243.2 ac) of this AEI on DOE lands were developed, including 29 ha (71.7 ac, 10.7 percent) of the core and 75.1 ha (185.6 ac, 16.7 percent) of the buffer. For this AEI, LANL biological resources SMEs recommended only an additional 38.1 ha (94.1 ac) of the buffer be developed before additional USFWS consultations take place. Once this cap is reached or a single large-scale project is proposed, additional consultation will be required. By 2011, 45 ha (111.2 ac) of the core and 83 ha (205.1 ac) of the buffer had been developed.

Three Mile—In 1999, 25.3 ha (62.5 ac) of this AEI on DOE lands were developed, including 3.8 ha (9.4 ac, 2.8 percent) of the core and 21.5 ha (51.1 ac, 7.3 percent) of the buffer. For this AEI, LANL biological resources SMEs recommended only 64.3 ha (158.8 ac) additional area of buffer be developed before additional USFWS consultations take place. Once this cap is reached or a single large-scale project is proposed, additional consultation will be required. By 2011, 12 ha (29.6 ac) of the core and 37 ha (91.4 ac) of the buffer had been developed.

III. AREA OF ENVIRONMENTAL INTEREST SITE PLAN FOR THE SOUTHWESTERN WILLOW FLYCATCHER

1.0 SPECIES DESCRIPTION—SOUTHWESTERN WILLOW FLYCATCHER

1.1 Status

In 1995, the USFWS designated the Southwestern Willow Flycatcher as a federally endangered species (60 FR 10693). The USFWS most recently designated critical habitat for the Southwestern Willow Flycatcher in 2005 (70 FR 60885). The most recent recovery plan was published for Southwestern Willow Flycatcher in 2002 (USFWS 2002).

1.2 General Biology

The Southwestern Willow Flycatcher is one of four subspecies of the Willow Flycatcher. The historic range of the Southwestern Willow Flycatcher included Arizona, California, Colorado, New Mexico, Texas, Utah, and Mexico. Currently, this flycatcher breeds in riparian habitats from southern California to Arizona and New Mexico, plus southern Colorado, Utah, Nevada, and far western Texas. In winter it is found in southern Mexico, Central America, and northern South America (USFWS 2002).

Southwestern Willow Flycatchers are present in New Mexico from early May through mid-September and breed from late May through late July (Finch and Kelly 1999; USFWS 2002; Yong and Finch 1997). The flycatcher's nesting cycle is approximately 28 days. Three or four eggs are laid at one-day intervals, and incubation begins when the clutch is complete. The female incubates eggs for approximately 12 days, and the young fledge about 13 days after hatching.

Southwestern Willow Flycatchers typically raise one brood per year (USFWS 2002). Because arrival dates vary, northbound migrant Willow Flycatchers (of all subspecies) pass through areas where Southwestern Willow Flycatchers have already begun nesting. Similarly, southbound migrants (of all subspecies) in late July and August may occur where Southwestern Willow Flycatchers are still breeding. Therefore, it is only during a short period of the breeding season (approximately June 15 through July 20) that one can assume that a Willow Flycatcher seen within Southwestern Willow Flycatcher range is probably of that subspecies (USFWS 2002).

The Southwestern Willow Flycatcher only nests along rivers, streams, and other wetlands. It is found in close association with dense stands of willows (*Salix* spp.), arrowweed (*Pluchea* spp.), buttonbush (*Cephalanthus* spp.), tamarisk (*Tamarix* spp.), Russian olive (*Eleagnus angustifolia* L.), and other riparian vegetation, often with a scattered overstory of cottonwood (*Populus* spp.) (USFWS 2002). The size of vegetation patches or habitat mosaics used by Southwestern Willow Flycatchers varies considerably and ranges from as small as 0.8 ha (1.9 ac) to several hundred hectares (Hatten and Paradzick 2003). The Southwestern Willow Flycatcher nests in thickets of trees and shrubs approximately 2 to 15 m (6 to 49 ft) tall, with a high percentage of canopy cover and dense foliage from 0 to 4 m (0 to 13 ft) above ground. Regardless of the plant species composition or height, occupied sites always have dense vegetation in the patch interior (Allison et al. 2003; USFWS 2002).

The Southwestern Willow Flycatcher is an insectivore. It forages within and occasionally above dense riparian vegetation, taking insects on the wing and gleaning them from foliage. The flycatcher's prey includes flies, bees, wasps, ants, beetles, moths, butterflies, grasshoppers, crickets, dragonflies, damselflies, and spiders (Durst et al. 2008; Wiesenborn and Heydon 2007).

1.3 Threats

The current population of Southwestern Willow Flycatchers in the United States is estimated at 1,214 territories (Durst et al. 2006). The distribution of breeding groups is highly fragmented, with groups often separated by considerable distances. This subspecies has suffered declines attributed to extensive loss of its cottonwood-willow habitat and to poor productivity resulting from brood parasitism by Brown-headed Cowbirds (*Molothrus ater*) (USFWS 2002).

2.0 IMPACT OF HUMAN ACTIVITIES

2.1 Introduction

The primary threats to the Southwestern Willow Flycatcher on LANL property are 1) impacts on habitat quality from LANL operations and 2) disturbance of nesting flycatchers. This section includes a review and summary of the known effects of various types of human activities to the Southwestern Willow Flycatcher and an overview of the current levels of activities at LANL within species habitat.

2.2 Impacts on Habitat Quality

2.2.1 Development

Throughout the Southwest, riparian habitats are rare and tend to be small and separated by vast expanses of arid lands. The Southwestern Willow Flycatcher has experienced extensive loss and

modification of its habitat resulting from urban and agricultural development, water diversion and impoundment, channelization of waterways, livestock grazing, off-road vehicle and other recreational uses, and hydrological changes resulting from these and other land uses (USFWS 2002). River and stream impoundments, groundwater pumping, and overuse of riparian areas have altered as much as 90 percent of the Southwestern Willow Flycatcher's habitat (USFWS 2002). Loss of cottonwood-willow riparian forests has had widespread impact on the distribution and abundance of bird species associated with that forest. Development itself may be tolerated if the habitat is left intact.

Because watercourses at LANL tend to be intermittent to ephemeral, riparian habitat is uncommon. There has been extensive degradation of the riparian zone along the Rio Grande caused by feral cattle grazing and flood control operations of Cochiti Lake. There are other riparian/wetland areas on LANL associated with canyon bottoms, the most significant one being Pajarito wetlands in the lower end of Pajarito Canyon. A major paved road traverses the wetlands area in Pajarito Canyon.

2.2.2 Ecological Risk

There is no specific information on the impact of chemicals on Southwestern Willow Flycatcher.

2.2.2.1 Ecorisk Assessment

LANL completed two ecological risk assessments that included the Southwestern Willow Flycatcher between 1997 and 2009. The ecological risk assessment process involves using computer modeling to assess potential effects to animals from COPCs that have been detected in the environment. The ecological risk assessments concluded that, in general, there is a small potential for effects to Southwestern Willow Flycatcher from COPCs (Gonzales et al. 1998; Gonzales et al. 2009).

An ecotoxicological risk assessment for the Southwestern Willow Flycatcher, centered on the Pajarito wetlands, found that between 7 and 16 percent of 100 hypothetical nest sites examined had hazard indices >1.0 and <10.0 , depending on the foraging scenario (Gonzales et al. 1998). This indicates a small potential for impacts from chemicals. The primary chemicals driving the risk scenario were pentachlorophenol, aluminum, radium-226, calcium, and thorium-228. Aluminum, radium, and thorium are naturally occurring substances in northern New Mexico.

2.2.3 Disturbance

2.2.3.1 Pedestrians and Vehicles

There is no specific information on the reactions of Southwestern Willow Flycatchers to pedestrians and vehicles available. The recovery plan for the Southwestern Willow Flycatcher recommends providing protected areas, reducing unpredictable activities providing visual barriers, and reducing noise disturbance (USFWS 2002).

2.2.3.2 Aircraft

There is no specific information on the reaction of Southwestern Willow Flycatchers to aircraft available.

LANL lies within restricted airspace and planes infrequently fly less than 609 m (2,000 ft) above ground level. The County of Los Alamos operates an airport along the northern edge of LANL. The airport is located on the southern rim of Pueblo Canyon. Most flights approach and depart to the east of the airport, over the Rio Grande.

2.2.3.3 Explosives

There is no specific information on the reaction of Southwestern Willow Flycatchers to explosives detonation available. The Southwestern Willow Flycatcher AEI is not located close to any explosives testing sites at LANL.

2.2.3.4 Other Sources of Noise

LANL biological resources SMEs do not have good information on the effects of noise, including machinery operation, on Southwestern Willow Flycatchers. However, Southwestern Willow Flycatchers are probably not as sensitive to disturbance as some other threatened or endangered species (USFWS 2002). For a description of noise levels at LANL, see Part I, Section 2.2.3.

2.2.3.5 Artificially Produced Light

There is no information on the effects of artificially produced light on Southwestern Willow Flycatchers available. Under the Los Alamos County Code, commercial site development plans are reviewed to ensure that lighting serves the intended use of the site while minimizing adverse impacts to adjacent residential property (Section 16-276). Section 16-276 of the County Code includes light source measurement limitations by zoning district. The code allows off-site light to be 0.5 fc in residential areas. By comparison, full moonlight measures 0.1 fc, and a crescent moon was measured at 0.01 fc.

3.0 AEI GENERAL DESCRIPTION FOR SOUTHWESTERN WILLOW FLYCATCHER

The AEI consists of two types of areas—core and buffer. Core areas represent wetland areas with suitable vegetation for nesting, primarily dense willows. The buffer area is the area within 100 m (328 ft) of core areas. The Southwestern Willow Flycatcher AEI on LANL consists of two separate core areas. For purposes of this site plan, both core areas and associated buffers are considered one AEI unit.

3.1 Method for Identifying the Southwestern Willow Flycatcher AEI

The core areas were defined by the presence of riparian habitat and suitable wetland vegetation. These areas were identified in 1994 during a survey of wetlands at LANL and mapped using a global positioning system receiver. Wetlands without stands of dense willows at least 2 m (7 ft) tall and 30 m (98 ft) wide were not included in the AEI. The buffer area is the area within 100 m (328 ft) of the core areas.

3.2 Location of the Southwestern Willow Flycatcher AEI

LANL has one AEI for Southwestern Willow Flycatcher. It is composed of two core areas with associated buffers. The AEI core areas are located in the bottom of Pajarito Canyon, on the eastern side of LANL adjacent to Pajarito Road and State Road 4. The boundaries of the Southwestern

Willow Flycatcher AEI are maintained in the biological resources program GIS database at LANL.

4.0 AEI MANAGEMENT

4.1 Overview

This AEI management section provides guidelines for LANL operations to reduce or eliminate the threats to the Southwestern Willow Flycatcher from 1) habitat alterations that reduce habitat quality and 2) disturbance of breeding or potentially breeding flycatchers. Habitat alterations are considered for all AEIs and for both core and buffer areas. Disturbance activities to flycatchers are considered only for occupied AEIs and only for impacts on core areas. Developed areas (see Part I, Section 2.3) with ongoing baseline levels of activities and are not suitable habitat for Southwestern Willow Flycatchers have different restrictions than undeveloped core or buffer areas. Therefore, the location of the disturbance activity within the AEI, the occupancy status of the AEI, and the type of activity all affect whether or not the activity is allowable. AEIs for different species may overlap, and an activity must meet the guidelines of all applicable site plans to be allowable. Protective measures are described as management practices that should be followed when working in AEIs.

4.2 Definition and Role of Occupancy in AEI Management

Summary: The occupancy status of an AEI affects what disturbance activities are allowable in different areas (core, buffer, developed) of the AEI. The Southwestern Willow Flycatcher AEI is considered occupied during May 15 through September 15 or until the surveys show the AEI to be unoccupied. See the Activity Table (Table 2, Section 4.5.2) for restrictions on occupied undeveloped core and buffer areas, and Part I, Section 2.3 for restrictions on developed areas.

Occupancy simply refers to whether or not an AEI is occupied during a species' period of sensitivity. For Southwestern Willow Flycatchers, LANL biological resources SMEs are primarily concerned with protecting the birds from disturbance during the breeding season. Because individuals may colonize suitable habitat, the Southwestern Willow Flycatcher AEI is treated as though it is occupied from May 15 through September 15 or until surveys show an AEI to be unoccupied. Southwestern Willow Flycatcher surveys are conducted during May, June, and July. Because Southwestern Willow Flycatchers migrate south for the winter, the AEI is treated as unoccupied from September 16 to May 14.

The occupancy status of an AEI affects what activities are allowable in the AEI. Although activities causing habitat alterations are always restricted, disturbance activities are restricted only in occupied AEIs. Table 2 provides dates and levels of disturbance activities allowable in the occupied Southwestern Willow Flycatcher AEI under the guidelines of this site plan. The dates in Table 2 indicate the time period during which the activity is restricted. Contact a LANL biological resources SME to find out the current occupancy status of an AEI (<http://int.lanl.gov/environment/bio/controls/index.shtml>).

4.3 Introduction to AEI Management Guidelines

Summary: The habitat alterations section (Section 4.4) and the activities section (Section 4.5) gives the guidelines for habitat alteration and disturbance activities, respectively, for the

Southwestern Willow Flycatcher AEI. The flow chart (see Figure 1) provides a quick reference to determine what, if any, guidelines need to be consulted for a specific activity. Protective measures give management practices that should be applied when working or considering work in AEIs. LANL biological resources SMEs are available to answer questions and provide advice (<http://int.lanl.gov/environment/bio/controls/index.shtml>).

Sections 4.4 and 4.5 provide the guidelines for habitat alterations and allowable activities in AEI core and buffer areas. The flow chart (see Figure 1) provides a quick reference that should be used to determine whether a project or activity will affect an AEI and what sections of the site plan need to be consulted. The section on habitat alterations (Section 4.4) describes what and where habitat alterations are allowed under the guidelines of this site plan. The section and table on allowable activities (Section 4.5 and Table 2) describe what, when, and where disturbance activities are allowed in occupied AEIs under the guidelines of this site plan. If an activity does not meet the restrictions given in the guidelines, the activity must be individually reviewed for ESA compliance. This site plan only provides guidelines for the Southwestern Willow Flycatcher AEI. If an activity is desired in an area with overlapping AEIs, all applicable site plans must be consulted. Section 4.6 describes management practices that should be applied when working or considering work in an AEI. LANL biological resources SMEs are available to help interpret site plans and answer questions (<http://int.lanl.gov/environment/bio/controls/index.shtml>).

4.4 Definition of and Restrictions on Habitat Alterations

4.4.1 Definition of Habitat Alterations

Habitat alteration includes any action that alters over the long-term the soil structure, vegetative components necessary to the species, prey quality and quantity, water quality, hydrology, or noise or light levels in undeveloped areas of an AEI. Long-term means the alteration lasts for more than one year. Habitat alteration includes any activity that removes vegetative components important to the Southwestern Willow Flycatcher (primarily trees and shrubs). An actual activity may take place outside of the AEI and will be considered habitat alteration if consequences of the activity have effects inside the AEI core.

The habitat components most important to flycatchers include vegetative structure, food quality and quantity, and disturbance levels, including noise and light. The thickets of certain trees and shrubs along wetlands are important because they provide roost sites and a suitable habitat for nesting and foraging.

4.4.2 Fuels Management Practices to Reduce Wildfire Risk

Thinning within undeveloped buffer areas may include trees of any size to achieve 7.6 m (25 ft) spacing between tree crowns. However, clear cutting is not allowed in undeveloped buffer areas. No fuels management practices are allowed in core areas. Habitat alterations including thinning are not restricted in developed areas. All fuels management activities in developed and buffer areas must follow the guidelines in the Activity Table (Table 2, Section 4.5.2) if the AEI is occupied.

4.4.3 Utility Corridors

Habitat alterations such as cutting down trees that threaten power lines are allowed within 8 m (26 ft) of either side of an existing utility line in all areas of an AEI (Trujillo and Racinez 1995).

New utility lines and utility lines requiring clearance of a right-of-way greater than 16 m (52 ft) total must be individually reviewed for ESA compliance. Disturbance activities must follow the guidelines given in the Activities Table for occupied AEIs.

4.4.4 Restrictions on Habitat Alterations

Summary: Habitat alterations other than the utility corridor maintenance described above are not allowed in undeveloped core areas under the guidelines of this site plan. Habitat alteration in buffers is limited. If a project or activity is planned that would alter habitat in an undeveloped core area, it must be individually evaluated for ESA compliance. Habitat alterations in a buffer area other than fuels management activities or utility corridor maintenance must be reported to a LANL biological resources SME for tracking (<http://int.lanl.gov/environment/bio/controls/index.shtml>).

4.5 Definition of and Restrictions on Disturbance Activities

4.5.1 Definition of Disturbance Activities

LANL biological resources SMEs considered five categories of activities that might cause disturbance in an AEI. Most of the categories were first identified in the document “Peregrine Falcon Habitat Management in the National Forests of New Mexico” prepared for the U.S. Forest Service (Johnson 1994). Other light production and other noise production were included to provide the most comprehensive list of activities possible, reducing the need for individual review of activities for ESA compliance. The categories of activities are people, vehicles, aircraft, other light production, and other noise production. The impact of explosives detonation on this species is not considered here because there are no explosives testing sites within 2 km (1.25 mi) of potential nesting habitat. Low, medium, and high levels of impact for these activities are considered here. The following categories of activities are restricted only in AEIs that are classified as occupied.

People—includes any entry of people into an AEI on foot.

- Low impact is the presence of three or fewer people per project and duration of one day or less during a breeding season.
- Medium impact is the exceedance of either the number of people or the duration criteria.
- High impact is the exceedance of both the number of people and the duration criteria.

Vehicles—includes the entry of any two-axle highway vehicle, all-terrain vehicle, or motorized machinery into an AEI by any route other than a paved road or an improved gravel road.

- Low impact is the presence of two or fewer vehicles per project and duration of one day or less during a breeding season.
- Medium impact is the exceedance of either the number of vehicles or the duration criteria.
- High impact is the exceedance of both the number of vehicles and the duration criteria.

Aircraft—includes the operation of any aircraft below an elevation of 600 m (2,000 ft) above the highest ground level in the local vicinity.

- Low impact is the presence of one single-engine airplane and duration of one day or less during a breeding season.
- Medium impact is the exceedance of either the number of aircraft or the duration criteria.
- High impact is the exceedance of both the number of aircraft and the duration criteria.

Any use of helicopters, jet airplanes, and propeller airplanes with two or more engines is classified as medium impact or above, depending on duration.

Other Light Production—includes any activity not previously listed that causes additional light to occur in an AEI core area (e.g., plans for construction of a new building at the edge of a developed area may call for lighting at night to facilitate nighttime work that impacts an undeveloped core area).

- Low impact is the increase of light intensity by up to 0.05 fc and a duration of one night or less per project per breeding season.
- Medium impact is the exceedance of either the intensity or duration criteria.
- High impact is the exceedance of both the intensity and duration criteria.

Measurements for increases in light are taken at the AEI core area boundary closest to the light source, if the source is outside the core, and at 10 m (33 ft) from the source if the source is inside the core. Light measurements for developed areas are taken at the edge of the developed area if the developed area is within an AEI core, or at the closest core boundary, if the developed area is outside of an AEI core.

Other Noise Production—includes any activity not previously listed except for explosives detonation that causes additional noise to occur in an AEI. For example, operation of machinery causes noise.

- Low impact is increasing noise levels in an AEI core by 6 dB(A) or less for one day or less per project per breeding season.
- Medium impact is the exceedance of either the level or the duration criteria.
- High impact is the exceedance of both the level and the duration criteria.

Measurements for increases in noise are taken at the AEI core boundary closest to the noise source if the source is outside the core, and at 10 m (33 ft) from the source if the source is inside the core. Noise measurements for developed areas are taken at the edge of the developed area if the developed area is within an AEI core, or at the closest core boundary if the developed area is outside of an AEI core.

4.5.2 Activity Table

Disturbance activities are of concern only when Southwestern Willow Flycatchers occupy an AEI. The AEI is always considered occupied between May 15 and September 15, or until surveys show the AEI to be unoccupied. The Southwestern Willow Flycatcher AEI is always considered unoccupied between September 16 and May 14, when flycatchers have migrated for the winter.

For occupancy status of an AEI after completion of surveys, contact a LANL biological resources SME (<http://int.lanl.gov/environment/bio/controls/index.shtml>).

Table 2. Restrictions on Activities in Undeveloped Occupied Southwestern Willow Flycatcher AEI

<i>Restrictions on Occupied Habitat</i>	Core	Buffer
<i>People</i>		
Low	No Restrictions	No Restrictions
Medium	May 15 to August 15	No Restrictions
High	May 15 to September 15	No Restrictions
<i>Vehicles</i>		
Low	May 15 to September 15	No Restrictions
Medium	May 15 to September 15	No Restrictions
High	May 15 to September 15	No Restrictions
<i>Aircraft</i>		
Low	No Restrictions	No Restrictions
Medium	May 15 to August 15	May 15 to August 15
High	May 15 to September 15	May 15 to August 15
<i>Other Light/Noise Production</i>		
Low	May 15 to September 15	No Restrictions*
Medium	May 15 to September 15	No Restrictions*
High	May 15 to September 15	No Restrictions*

*Noise or light production in the buffer is restricted if the activity would violate core area restriction on noise or light.

4.6 Protective Measures

Summary: This section provides a list of management practices to apply in the AEI.

- No wetland vegetation will be removed outside of developed areas.
- Appropriate erosion and runoff controls should be employed to reduce soil loss.
- Avoid unnecessary disturbance to vegetation (e.g., excessive parking areas or equipment storage areas, off-road travel, materials storage areas, crossing of streams or washes).
- Avoid removal of vegetation along drainage systems and stream channels.
- Avoid all vegetation removals not absolutely necessary.
- Appropriate erosion controls must be put in place and periodically checked throughout the life of any projects.
- All exposed soils must be revegetated as soon as feasible after disturbance to minimize erosion.

5.0 SOUTHWESTERN WILLOW FLYCATCHER AEI DESCRIPTION

5.1 Pajarito Canyon Southwestern Willow Flycatcher AEI

5.1.1 Allowable Habitat Alteration in the Buffer Area

Since the purpose of the buffer area is to help maintain the core area as suitable Southwestern Willow Flycatcher habitat, habitat alteration in the buffer area will be extremely limited. There are two areas in which restrictions on habitat alteration are relaxed.

1. The mesa top of Mesita del Buey. This mesa top can be developed as long as restrictions on impacts to the core area are met.
2. Pajarito Road within the AEI. Mowing of upland vegetation is allowed up to 5 m (15 ft) from Pajarito Road, or to the fence, if the fence is within 9 m (30 ft). Vegetation must cover the roadsides to prevent sediment runoff, so mowed plants should be at least 5 cm (2 in) high. LANL biological resources SMEs encourage the growth of willow throughout the AEI—even the area along Pajarito Road—to enhance habitat. If, within this area, it is absolutely necessary to remove new willow growth (i.e., to improve visibility for human safety), LANL biological resources SMEs recommend that only willows at or above the level of the roadway surface be mowed.

IV. AREA OF ENVIRONMENTAL INTEREST SITE PLAN FOR THE JEMEZ MOUNTAINS SALAMANDER

1.0 SPECIES DESCRIPTION—JEMEZ MOUNTAINS SALAMANDER

1.1 Status

The Jemez Mountains Salamander (*Plethodon neomexicanus*) was listed in New Mexico as endangered under the Wildlife Conservation Act of New Mexico in 2006 (NMDGF 2006). In September 2012 the USFWS proposed the Jemez Mountains Salamander as endangered under the ESA (FR 2012) and the final listing as endangered was on 10 September 2013 (FR 2013a)

1.2 General Biology

The Jemez Mountains Salamander is endemic to the Jemez Mountains of north-central New Mexico and is found in Los Alamos, Rio Arriba, and Sandoval counties (Stebbins and Riemer 1950). It is one of two endemic plethodontid salamanders that occur in New Mexico. It occurs predominantly at elevations between 2,130 to 3,430 m (6,988 to 11,254 ft) in mixed-conifer forest with greater than 50 percent canopy cover consisting mainly of Douglas fir (*Pseudotsuga menziesii* [Mirb.] Franco), blue spruce (*Picea pungens* Engelm.), Engelmann spruce (*Picea engelmannii* Parry ex Engelm.), white fir (*Abies concolor* [Gord. & Glend.] Lindl. ex Hildebr.), limber pine (*Pinus flexilis* James), ponderosa pine, and quaking aspen (*Populus tremuloides* Michx.). The ground surface in forest areas has (a) moderate to high volumes of large fallen trees and other woody debris, especially coniferous logs at least 25 cm (10 in) in diameter, particularly Douglas fir, which are in contact with the soil in varying stages of decay from freshly fallen to nearly fully decomposed; or (b) structural features, such as rocks, bark, and moss mats that provide

the species with food and cover. Underground habitat in forest or meadow areas contains interstitial spaces provided by (a) igneous rock with fractures or loose rocky soils, (b) rotted tree root channels, or (c) burrows of rodents or large invertebrates (Degenhardt et al. 1996; FR 2013b).

Plethodontid salamanders, which lack both lungs and gills, breathe through the mucous membranes in their mouth and throat and through their moist skin. The Jemez Mountains Salamander is completely terrestrial and does not use standing surface water for any life stage (FR 2012). Present in its habitat year-round, the Jemez Mountains Salamander spends most of its life underground, but can be found on the surface when conditions are warm and wet, approximately July through October. During this time, the Jemez Mountains Salamander can be found under rocks, bark, and moss mats and inside and under logs (Ramotnik 1986, Everett 2003). The Jemez Mountains Salamander eats invertebrates, including ants, mites, and beetles, and is thought to lay its eggs underground (FR 2013b).

1.3 Threats

Principal threats to habitat include historical fire exclusion and suppression and severe wildland fires; forest composition and structure conversions; post-fire rehabilitation; forest and fire management; roads, trails, and habitat fragmentation; recreation; and disease (FR 2012).

2.0 IMPACT OF HUMAN ACTIVITIES

2.1 Introduction

Primary threats to the Jemez Mountains Salamander on LANL property are impacts to habitat quality or destruction of individual salamanders caused by LANL or Los Alamos County operations. Forested LANL property is also subject to impacts from severe wildland fire and wildfire suppression.

2.2 Impacts on Habitat Quality

2.2.1 Development

Property at LANL varies from remote isolated land to heavily developed and/or industrialized. Most of the large developed areas at LANL are found on mesa tops, generally in the northern and western portion of LANL. The areas of Jemez Mountains Salamander habitat currently most impacted by development occur in Los Alamos Canyon. There is a secondary paved road (West Road) in the bottom of the canyon that exits the canyon on the north-facing slope through Jemez Mountains Salamander habitat. The canyon bottom also contains a recreational ice rink operated by Los Alamos County on an inholding owned by Los Alamos County. Development that reduces the occurrence of primary constituent elements of Jemez Mountains Salamander in core habitat would likely have a negative impact on the species.

2.2.2 Pedestrians and Vehicles

Many canyon bottoms and mesa tops at LANL have dirt roads traversing them. Most of these roads are gated; however, many of these roads are accessible to LANL employees and the public on foot or by bike. Some areas, such as Los Alamos Canyon, are frequently used by hikers and dog owners on active and historic trails which traverse the canyon, through Jemez Mountains

Salamander habitat in places. Maintenance of roads and trails in the habitat may have a negative impact on the species.

2.2.3 Severe Wildland Fire and Wildfire Suppression

Stand-replacing wildfires significantly change forest composition and structure, and reduce canopy cover. Even ground wildfires may reduce the volume of fallen logs and large woody debris. Large areas of historic Jemez Mountains Salamander habitat have been impacted by stand-replacing wildfires associated with current forest stocking conditions, drought, and high temperatures (FR 2012). Forested habitats on LANL are also subject to severe wildland fires. To mitigate wildfire risks, some areas of LANL have been treated for fuels reduction and creation of fuel breaks both pre-emptively and during active wildfire suppression. Both wildfires and wildfire suppression activities can negatively impact the primary constituent elements of Jemez Mountains Salamander core habitat.

2.3 Impacts on Individual Salamanders

2.3.1 Disease

The amphibian pathogenic fungus *Batrachochytrium dendrobatidis* (Bd) was found in a wild-caught Jemez Mountains Salamander in 2003 (Cummer et al. 2005) on the east side of the species' range and again in another Jemez Mountains Salamander in 2010 on the west side of the species' range (FR 2012). Bd causes the disease chytridiomycosis, whereby the Bd fungus attacks keratin in amphibians. In adult amphibians, keratin primarily occurs in the skin. The symptoms of chytridiomycosis can include sloughing of skin, lethargy, morbidity, and death. Chytridiomycosis has been linked with worldwide amphibian declines, die-offs, and extinctions, possibly in association with climate change (Pounds et al. 2006). Chytridiomycosis may be a threat to the Jemez Mountains Salamander because this disease is a threat to many other species of amphibians and the pathogen has been detected in the Jemez Mountains Salamander (FR 2012).

As part of a cooperative study with the New Mexico Department of Game and Fish between 2007 and 2013, various amphibian species including the canyon tree frog (*Hyla arenicolor*), western chorus frog (*Pseudacris triseriata*), Woodhouse's toad (*Anaxyrus woodhousii*), tiger salamander (*Ambystoma tigrinum*), and Jemez Mountains Salamander were tested for Bd infection at LANL. To date, all sampling has been negative for Bd infection (Fresquez et al. 2013).

2.3.2 Destruction of Individual Salamanders

During periods of the year when Jemez Mountains Salamander are on the soil surface, when conditions are warm and wet (generally July to October), they are vulnerable to injury and mortality from soil-disturbing activities, including operation of heavy equipment in core habitat. They also are at risk to be found and collected by people.

3.0 AEI GENERAL DESCRIPTION FOR JEMEZ MOUNTAINS SALAMANDER

The AEI consists of two areas, a core area and a buffer area. The core habitat is defined as suitable habitat where the Jemez Mountains Salamander occurs or may occur at LANL. The core habitat consists of sections of north-facing slope that contain the required micro-habitat to support Jemez

Mountains Salamander. The buffer area is 100 m (328 ft) wide extending outward from the edge of the core area.

3.1 Method for Identifying a Jemez Mountains Salamander AEI

The first step in identifying potential Jemez Mountains Salamander at LANL was to use a GIS to model habitat. Early modeling efforts by Hathcock (2008) identified areas of potential habitat and that model was further refined. The following parameters were modeled in the GIS:

- Elevation: 7,000 ft (2,150 m) and above
- Slope: Greater than 20 degrees
- Aspect: north-facing +/- 20 degrees
- Land cover: Mixed conifer
- Land use: Undeveloped
- Modeled habitat is only selected if it is greater than five contiguous 30 × 30 m (98 × 98 ft) pixels in size

Once this habitat layer was developed, a second layer was modeled that examined the level of shade in the habitat, also known as an illumination index. Since the Jemez Mountains Salamander needs cool moist conditions, an illumination index model would further highlight areas where this habitat type may occur or further reinforce the areas selected by the GIS modeling. The illumination index describes the amount and extent of solar radiation reaching the Earth's surface at a given point. This takes into account the topography that may cast shadows. The illumination model was developed using the 5 m (16 ft) resolution digital elevation model hillshade and using the Surface toolbox in ArcToolbox (Environmental Science Research Institute, Redlands, California) using the highest height of the sun on June 21 at 1:00 pm, altitude of 74.4 and Azimuth of 178.4, when the sun would be at its maximum height. These procedures were based on work done by Reilly et al. (2009).

Once this modeling was complete, LANL biological resources SMEs performed field validation to verify the suitability of the modeled habitat. The goal was to verify that mixed conifer was still the dominant cover class in the selected area. The GIS analysis used data from a landcover map created by McKown et al. (2003). There have been changes in habitat since this landcover map was published from fire and extreme drought effects. Since LANL is on the extreme edge of Jemez Mountains Salamander lower elevational range, a key component in this part of its range is soil moisture content. During field validation, evidence of a moist mixed conifer habitat versus a dry mixed conifer habitat was noted. One of the key indicators used to delimit areas of moist versus dry mixed conifer during the field validation was the presence of white fir (Evans et al. 2011) combined with a high canopy cover.

Field validation of the model occurred in May 2013, or decisions were based on earlier field visits to the sites from other projects. Each field validation consisted of LANL biological resources SMEs walking down all of the modeled habitat polygons to look for the presence of indicator features. If a polygon of modeled habitat contained white fir, indicating a moist wet conifer type habitat, a high canopy closure, and other signs of high habitat quality such as dead logs, moss or

other areas that could be used as cover by the Jemez Mountains Salamander, then the polygon was marked for retention in the final core habitat. Polygons that did not contain the necessary habitat requirements were omitted.

After the field validation was complete, the final core habitat boundaries that LANL would recognize were hand digitized using ArcGIS (Environmental Science Research Institute, Redlands, California) by LANL biological resources SMEs in and around the validated modeled polygon and areas between polygons if appropriate. The final identified core habitat at LANL occurs on the north-facing slopes of canyons. Toward the rim of the canyon the core boundaries end where the mixed conifer ends. In the canyon bottoms the core boundary extends to the edge of the stream channel. The upstream and downstream core boundaries end where the mixed conifer ends. A buffer habitat was extended around the core to a distance of 100 m (328 ft) outward. The LANL Fenton Hill satellite facility in the Jemez Mountains off of New Mexico Highway 126 is on land leased to DOE by the Santa Fe National Forest. The entire footprint is considered to be developed core habitat for the Jemez Mountains Salamander, since proposed critical habitat is adjacent to the facility.

3.2 Location and Number of Jemez Mountains Salamander AEIs

The identified Jemez Mountains Salamander core habitats were grouped by canyon system into AEIs, which contain contiguous and noncontiguous habitat areas. The largest contiguous section of habitat at LANL is in Los Alamos Canyon. There are two noncontiguous areas of habitat in Two-mile Canyon, four in Pajarito Canyon, one contiguous area in Cañon de Valle, and the entire Fenton Hill facility.

4.0 AEI MANAGEMENT

4.1 Overview

This AEI management section provides guidelines for LANL operations to reduce or eliminate the threats to the Jemez Mountains Salamander from habitat alterations that reduce habitat quality. Habitat alterations are considered for all AEIs and for both core and buffer areas. Developed areas that have ongoing baseline levels of activities and are not suitable habitat for Jemez Mountains Salamander have different restrictions than undeveloped core or buffer areas. AEIs for different species may overlap, and an activity must meet the guidelines of all applicable site plans to be allowable. Protective measures are described as management practices that should be followed when working in AEIs.

4.2 Definition and Role of Occupancy in AEI Management

Occupancy simply refers to whether or not an AEI is occupied by the Jemez Mountains Salamander. The Los Alamos Canyon AEI is known to be occupied based on past surveys. Surveys for the Jemez Mountains Salamander are known to have a very low detection rate for occupied areas, so at LANL all AEIs are assumed to be occupied at all times. If needed, site-specific surveys will be conducted by federally permitted LANL biological resources SMEs.

4.3 Definition and Role of Developed Areas in AEI Management

Developed areas include all building structures, paved roads, improved gravel roads, and paved and unpaved parking lots. The majority of Jemez Mountains Salamander core habitat is in undeveloped areas, except for the satellite facility at Fenton Hill and a small amount of habitat in Los Alamos Canyon where West Road crosses the habitat. Generally, developed areas will not have restrictions; however, some of the undeveloped sections within the footprint of Fenton Hill may have restrictions because they may contain Jemez Mountains Salamanders when they move to the surface between July and October. Any project that occurs within developed core habitat will be evaluated by LANL biological resources SMEs for ESA compliance.

4.4 General Description of Core and Buffer Areas and Allowable Area Development

The purpose of buffer areas is to protect core areas from habitat degradation. The current levels of development in buffer and core areas represent baseline conditions for this site plan. No further development is allowed in the core area under the guidelines of this site plan. Any development in a buffer area will be reviewed by LANL biological resources SMEs to ensure that there are no impacts to the core habitat.

4.5 Emergency Actions

If safety and/or property are immediately threatened by something occurring within an AEI (for example, wildfire, water line breakage, etc.) please contact a LANL biological resources SME (1-505-665-3366) as soon as possible. If the emergency occurs outside of regular business hours, contact the Emergency Management Office (1-505-667-6211). This office will then communicate with the appropriate LANL personnel.

4.6 Introduction to AEI Management Guidelines

Section 4.7 provides the guidelines for habitat alterations and allowable activities in AEI core and buffer areas. It describes what and where habitat alterations are allowed under the guidelines of this site plan. If an activity does not meet the restrictions given in the guidelines, the activity must be individually reviewed for ESA compliance. This site plan only provides guidelines for the Jemez Mountains Salamander AEIs. If an activity is desired in an area with overlapping AEIs, all applicable site plans must be consulted. AEI maps show the location of all AEIs in an area. LANL biological resources SMEs are always available to help interpret site plans and answer questions (<http://int.lanl.gov/environment/bio/controls/index.shtml>).

4.7 Definition of and Restrictions on Habitat Alterations

4.7.1 Definition of Habitat Alterations

Habitat alteration includes any action that alters the soil structure, vegetative components necessary to the species, water quality, or hydrology in undeveloped areas of an AEI. An actual activity may take place outside of the AEI and will be considered habitat alteration if consequences of the activity have effects inside the AEI core. Habitat alterations would also include soil pits for soil samples deeper than 15 cm (6 in) using either hand or mechanized augers. Any activity that might disturb the soil will need to be reviewed by LANL biological resources SMEs.

The habitat components most important to the Jemez Mountains Salamander include soil structure and vegetative structure. The forest structure within an area designated as a Jemez Mountains Salamander AEI is important because it provides the necessary moist, cool microclimate.

4.7.2 Fuels Management Practices to Reduce Wildfire Risk

One of the primary threats to the Jemez Mountains Salamander is wildfire (FR 2012), but they also require habitat with a high canopy cover which makes fuels reduction challenging. Within undeveloped core areas, thinning trees to a level of 80 percent canopy cover or higher is approved. Trees may not be thinned below 80 percent canopy cover without further ESA review by LANL biological resources SMEs. Large logs on the ground should be left in place and not chipped. Understory thinning that does not reduce total canopy cover below 80 percent is permitted. Large trees that are felled should be left as large logs on the ground. Smaller trees and understory shrubs that may be thinned should be dispersed and left on-site to aid in soil moisture retention. Thinning activities should not occur during the rainy season between July to October (or when freezing temperatures begin, whichever comes first) when the Jemez Mountains Salamander is found on the surface.

In buffer areas, thinning of trees can occur to the current LANL-approved prescription level (LAAO 2000). LANL biological resources SMEs are available to provide guidance and mark trees for thinning (<http://int.lanl.gov/environment/bio/controls/index.shtml>).

4.7.3 Utility Corridors

Habitat alterations such as cutting down trees that threaten power lines are allowed within 8 m (26 ft) of either side of an existing electrical utility line at LANL under existing guidelines and engineering controls (Hathcock 2013). This level is approved in all areas of an AEI. New utility lines and utility lines requiring clearance of a right-of-way greater than 16 m (52 ft) total in core habitat must be individually reviewed for ESA compliance.

4.7.4 Restrictions on Habitat Alterations

Habitat alterations other than the fuels management practices and utility corridor maintenance described above are not allowed in undeveloped core areas under the guidelines of this site plan. If a project or activity is planned that would alter habitat in an undeveloped core area, it must be individually evaluated for ESA compliance. Habitat alterations in buffer areas must be reviewed by LANL biological resources SMEs to ensure that there are no impacts to core habitat.

REFERENCES CITED

- Allison, L.J., C.E. Paradzick, J.W. Rourke, and T.D. McCarthey. 2003. A characterization of vegetation in nesting and non-nesting plots for southwestern willow flycatchers in central Arizona. In *Ecology and Conservation of the Willow Flycatcher* (eds) M.K. Sogge, B.E. Kus, S.J. Sferra & M.J. Whitfield. Studies In Avian Biology: Cooper Ornithological Society.
- Brown, B.T., G.S. Mills, C. Powels, W.A. Russell, G.D. Therres, and J.J. Pottie. 1999. The influence of weapons-testing noise on bald eagle behavior. *Journal of Raptor Research* 33:227–32.
- Brown, B.T. and L.E. Stevens. 1997. Winter bald eagle distribution is inversely correlated with human activity along the Colorado River, Arizona. *Journal of Raptor Research* 31:7–10.
- Burns, M.J. 1995. White Rock noise measurements during PHERMEX tests, 11 March 1995. Los Alamos National Laboratory Memorandum DX-DO:DARHT-95-31 and 35.
- Cain, B.W. 1988. The impact of environmental contaminants on Southwestern USA raptors. *Proceedings of the Southwest Raptor Management Symposium and Workshop* (ed) by R.L. Glinski, B.G. Pendleton, M.B. Moss, M.N. LeFranc Jr., B.A. Millsap & S.W. Hoffman, 348–54. Tucson, AZ, USA, May 21–24, 1986: National Wildlife Federation, Washington, D.C., USA.
- Cummer, M. R., D. E. Green, and E. M. O'Neill. 2005. Aquatic chytrid pathogen detected in terrestrial plethodontid salamander. *Herpetological Review* 36(3):248–249.
- Degenhardt, W.G., C.W. Painter, and A.H. Price. 1996. *Amphibians and Reptiles of New Mexico*. University of New Mexico Press, Albuquerque, New Mexico.
- Delaney, D.K., T.G. Grubb, P. Beier, L.L. Pater, and M.H. Reiser. 1999. Effects of helicopter noise on Mexican spotted owls. *Journal of Wildlife Management* 63:60–76.
- Department of Energy (DOE). 1996. Dual-Axis Radiographic Hydrodynamic Test Facility final environmental impact statement mitigation action plan. DOE/EIS-0228.
- Durst, S.L., M.K. Sogge, H.C. English, S.O. Williams, B.E. Kus, and S.J. Sferra. 2006. Southwestern Willow Flycatcher breeding site and territory summary – 2005. USGS Southwest Biological Science Center report to the U.S. Bureau of Reclamation.
- Durst, S.L., T.C. Theimer, E.H. Paxton, and M.K. Sogge. 2008. Age, habitat, and yearly variation in the diet of a generalist insectivore, the southwestern willow flycatcher. *Condor* 110:514–25.
- Environmental Protection Agency (EPA). 2010. National Pollutant Discharge Elimination System Storm Water Individual Permit number NM0030759.

Threatened and Endangered Species Habitat Management Plan

- Evans, A.M., R.G. Everett, S.L. Stephens, and J.A. Youtz. 2011. Comprehensive Fuels Treatment Practices Guide for Mixed Conifer Forests: California, Central and Southern Rockies, and the Southwest. Forest Guild 106pp.
- Everett, E. 2003. Habitat Characterization and Environmental Influences of the Jemez Mountains Salamander (*Plethodon neomexicanus*). M.S. Thesis, New Mexico State University, Las Cruces, New Mexico, 55pp.
- Federal Register. 2012. September 12, 2012. Endangered and Threatened Wildlife and Plants; Proposed Endangered Status for the Jemez Mountains Salamander and Proposed Designation of Critical Habitat. Proposed Rule 77(177):56482-56513.
- Federal Register. 2013a. September 10, 2013. Endangered and Threatened Wildlife and Plants; Determination of Endangered Species Status for Jemez Mountains Salamander (*Plethodon neomexicanus*) Throughout Its Range. 78(175):55600-55627.
- Federal Register. 2013b. February 12, 2013. Endangered and Threatened Wildlife and Plants; Endangered Status and Designation of Critical Habitat for the Jemez Mountains Salamander. Proposed rule; reopening of comment period 78(29):9876-9882.
- Finch, D.M. and J.F. Kelly. 1999. Status and migration of the southwestern willow flycatcher in New Mexico. In *Rio Grande Ecosystems: Linking Land, Water, and People: Toward a Sustainable Future for the Middle Rio Grande Basin* (ed) D.M. Finch, J.C. Whitney, J.F. Kelly & S.R. Loftin, 197–203, Albuquerque, New Mexico.
- Fresquez, P.R., C. Hathcock, D. Keller, and J. Fair. 2013. “Foodstuffs and Biota Monitoring”, in Environmental Report 2012. Los Alamos National Laboratory report LA-UR-13-27065.
- Gallegos, A., G. Gonzales, K. Bennett, and L. Pratt. 1997. Preliminary Risk Assessment of the Mexican Spotted Owl under a Spatially-weighted Foraging Regime at the Los Alamos National Laboratory. LANL report LA-13259-MS.
- Gonzales, G., R. Rytty, P. Newell, A. Gallegos, and S. Sherwood. 2004. Modeled Ecological Risk to the Deer Mouse, Mexican Spotted Owl, and Western Bluebird at the Los Alamos National Laboratory using ECORSK.7. LANL report LA-14118.
- Gonzales, G., P. Gallegos, A. Gallegos, and K. Bennett. 2009. Site-wide Application of ECORSK.9 at the Los Alamos National Laboratory. LANL report LA-UR-09-02833.
- Ganey, J.L. and R.P. Balda. 1994. Habitat selection by Mexican spotted owls in northern Arizona. *Auk* 111:162–69.
- Gonzales, G.J., A.F. Gallegos, K.D. Bennett, M.A. Mullen, and T.S. Foxx. 1998. Preliminary Risk Assessment of the Southwestern Willow Flycatcher (*Empidonax traillii extimus*) at the Los Alamos National Laboratory. Los Alamos National Laboratory report LA-13508MS.

- Grubb, T.G. and W.W. Bowerman. 1997. Variations in breeding bald eagle responses to jets, light planes, and helicopters. *Journal of Raptor Research* 31:213–22.
- Grubb, T.G. and R.M. King. 1991. Assessing human disturbance of breeding bald eagles with classification tree models. *Journal of Wildlife Management* 55:500–11.
- Hansen, L.A. 2004. Sigma Mesa Construction Debris Recycling Project. Los Alamos National Laboratory Memorandum RRES/Ecol-04-0049.
- Hansen, L.A. 2005. A Biological Assessment of the Potential Effects of the Operation of an Asphalt Batch Plant and a Rock Crusher at Sigma Mesa on Federally Listed Threatened and Endangered Species. Los Alamos National Laboratory report LA-CP-05-0293.
- Hansen, L.A. 2009. Sound studies of the Biosafety Level 3 (BSL-3) Laboratory at TA-3, Building 1076. Los Alamos National Laboratory report LA-UR-09-05482.
- Hathcock, C.D. and T.K. Haarmann. 2008. Development of a predictive model for habitat of the Mexican spotted owl in Northern New Mexico. *Southwestern Naturalist* 53:34–38.
- Hathcock, C. D. 2008. The Status of the Jemez Mountains Salamander (*Plethodon neomexicanus*) at Los Alamos National Laboratory, 2008. Los Alamos National Laboratory Report LA-UR-08-0826.
- Hathcock, C.D., L.A. Hansen, and D.C. Keller. 2010. Occupancy of habitats by Mexican spotted owl in relation to explosives noise and recreational access at Los Alamos National Laboratory. *Western Birds* 41:102–06.
- Hathcock, C. D. 2013. Email from C. D. Hathcock to S. Martinez on June 20, 2013, Los Alamos National Laboratory communication.
- Hatten, J.R. and C.E. Paradzick. 2003. A multiscaled model of southwestern willow flycatcher breeding habitat. *Journal of Wildlife Management* 67:774–88.
- Holthuijzen, A.M.A., W.G. Eastland, A.R. Ansell, M.N. Kochert, R.D. Williams, and L.S. Young. 1990. Effects of blasting on behavior and productivity of nesting prairie falcons. *Wildlife Society Bulletin* 18:270–81.
- Huchton, K., S.W. Koch, and R.J. Robinson. 1997. An analysis of background noise in selected canyons of Los Alamos County. Los Alamos National Laboratory report LA-13372-MS.
- Johnson, J.A. and T.H. Johnson. 1985. Timber type model of spotted owl habitat in northern New Mexico. New Mexico Department of Game and Fish report, Santa Fe, New Mexico.
- Johnson, T.H. 1994. Peregrine falcon habitat management in national forests of New Mexico. USDA Forest Service unpublished report.

- Johnson, T.H. 1998. Topographic-Landsat model of suitable spotted owl habitat around Los Alamos National Laboratory. Los Alamos National Laboratory unpublished report.
- Keller, D.C. and T.S. Foxx. 1997. Biological assessment for threatened and endangered species at the DP Road Tract land transfer. Los Alamos National Laboratory unpublished report.
- Keller, D.C. and D. Risberg. 1995. Biological and floodplain/wetland assessment for the Dual-Axis Radiographic Hydrodynamics Test Facility (DARHT). Los Alamos National Laboratory report LA-UR-95-647.
- Knight, J.L. and S.S. Vrooman. 1999. A study of construction machinery noise levels at Los Alamos National Laboratory. Los Alamos National Laboratory report LA-UR-99-5740.
- Department of Energy, Los Alamos Area Office (LAAO). 2000. Environmental Assessment for the Wildfire Hazard Reduction and Forest Health Improvement Program at Los Alamos National Laboratory, Los Alamos, New Mexico. DOE-EA-1329.
- Los Alamos National Laboratory (LANL). 2013. Environmental Protection. Los Alamos National Laboratory Program Description 400, Revision 2.
- McKown, B., S.W. Koch, R.G. Balice, and P. Neville. 2003. Land Cover Classification Map for the Eastern Jemez Region. Los Alamos National Laboratory report LA-14029.
- New Mexico Department of Game and Fish (NMDGF), April 2006. Threatened and Endangered Species of New Mexico—2006 Draft Biennial Review and Recommendations. Authority: Wildlife Conservation Act (NMSA 17-2-37+B1 through 17-2-46, 1978).
- New Mexico Environment Department (NMED). 2005. Compliance Order on Consent New Mexico Environment Department.
- Paakkonen, R. 1991. Low-frequency noise impulses from explosions. *Journal of Low Frequency Noise & Vibration* 10:78–82.
- Pounds, J.A., M.R. Bustamante, L.A. Coloma, J.A. Consuegra, M.P.L. Fogden, P.N. Foter, E. La Marca, K.L. Masters, A. Merino-Viteri, R. Puschendorf, S.R. Ron, G.A. Sanchez-Azofeifa, C.J. Still, and B.E. Yound. 2006. Widespread amphibian extinctions from epidemic disease driven by global warming. *Nature* 439(7073):161-167.
- Ramotnik, C.A. 1986. Status Report: *Plethodon neomexicanus* Jemez Mountains Salamander. U.S. Fish and Wildlife Service Report.
- Reilly, E.C., D. Clayton, R.S. Nauman, D.H. Olson, H.H. Welsh Jr, B. Devlin. 2009. Spatial Model of Optimal Habitat for the Siskiyou Mountains Salamander (*Plethodon stormi*) North of the Siskyou Crest. Chapter 2. In: Olson, D.H., D. Clayton, R.S. Nauman, and H.H. Welsh Jr (Editors). 2009. Conservation of the Siskiyou Mountains Salamander (*Plethodon stormi*). *Northwest Fauna* 6:1-73.

- Stebbins, R.C., and W.J. Riemer. 1950. A New Species of Plethodontid Salamander from the Jemez Mountains of New Mexico. *Copeia* 1950(2):73–80.
- Steidl, R.J. and R.G. Anthony. 2000. Experimental effects of human activity on breeding bald eagles. *Ecological Applications* 10:258–68.
- Swarthout, E.C.H. and R.J. Steidl. 2001. Flush responses of Mexican spotted owls to recreationists. *Journal of Wildlife Management* 65:312–17.
- Swarthout, E.C.H. and R.J. Steidl. 2003. Experimental effects of hiking on breeding Mexican spotted owls. *Conservation Biology* 17:307–15.
- Trujillo, C.T. and E. Racinez. 1995. Meeting notes on the 13.8-kV transmission line tree trimming. Los Alamos National Laboratory Memorandum FSS-8-95-114.
- U.S. Fish and Wildlife Service (USFWS). 1995. Recovery plan for the Mexican spotted owl. Albuquerque, New Mexico.
- U.S. Fish and Wildlife Service (USFWS). 2012. Recovery plan for the Mexican Spotted Owl, First Revision. Albuquerque, New Mexico.
- U.S. Fish and Wildlife Service (USFWS). 2002. Southwestern willow flycatcher recovery plan. Albuquerque, New Mexico.
- Vigil, E.A. 1995. Noise measurements at State Road 4 and Bandelier turn-off at State Road 4 during PHERMEX test on March 11, 1995. Los Alamos National Laboratory Memorandum ESH-5:95-11825.
- Vrooman, S.S., S.W. Koch, and J.L. Knight. 2000. Temporal and spatial variation in background noise levels at Los Alamos National Laboratory. Los Alamos National Laboratory report LA-13684-MS.
- Wiesenborn, W.D. and S.L. Heydon. 2007. Diets of breeding southwestern willow flycatchers in different habitats. *Wilson Journal of Ornithology* 119:547–57.
- Willey, D.W. 2013. Diet of Mexican Spotted Owls in Utah and Arizona. *The Wilson Journal of Ornithology* 125(4):775-781.
- Yong, W. and D.M. Finch. 1997. Migration of the willow flycatcher along the middle Rio Grande. *Wilson Bulletin* 109:253–68.

APPENDIX

Table A-1. The percentage of each food type found in Mexican Spotted Owl food remains at LANL

Species	Relative Abundance
<i>Neotoma</i> spp.	26.22
<i>Peromyscus</i> spp.	10.22
<i>Microtus</i> spp.	4.44
Gophers	4.89
Bats	5.78
Chipmunks	0.89
Rabbits	12.89
Shrews	1.33
Small Mammal	1.33
Medium Mammal	1.78
Medium Bird	8.00
Small Bird	4.89
Nocturnal Birds	0.89
Reptiles	4.89
Arthropods	11.56

Table A-2. Preliminary light measurements in ftc for Mexican Spotted Owl site plan

		Distance from Source			
Source (street light)		5 m	10 m	15 m	20 m
ftc	3.70	2.28	1.20	0.62	0.32

**K-2, U.S. Fish & Wildlife Concurrence
(Biological Assessment of Jemez Mtn Salamander Site Plan)**



United States Department of the Interior

FISH AND WILDLIFE SERVICE
New Mexico Ecological Services Field Office
2105 Osuna NE
Albuquerque, New Mexico 87113
Phone: (505) 346-2525 Fax: (505) 346-2542

December 9, 2013

Cons. #02ENNM00-2014-I-0014

Geoffrey L. Beausoleil, Acting Manager
National Nuclear Security Administration, Los Alamos Field Office
Department of Energy
Los Alamos, New Mexico 87544

Dear Mr. Beausoleil:

Thank you for your biological assessment entitled, "Biological Assessment of the Effects of Implementing the Jemez Mountains Salamander Site Plan on Federally Listed Threatened and Endangered Species at Los Alamos National Laboratory" (BA); the request for informal consultation and conferencing received on July 25, 2013 and supplemental information supplied in the "Jemez Mountains Salamander (*Plethodon neomexicanus*) Los Alamos National Laboratory (LANL) Site Plan" (Site Plan); and emails dated November 19 and December 3, 2013. The Department of Energy (DOE) requested concurrence with the determination of effects for the endangered Jemez Mountains salamander (*Plethodon neomexicanus*) (salamander) pursuant to Section 7(a)(2) of the Endangered Species Act of 1973 (ESA), as amended (16 U.S.C. § 1531 *et seq.*). Your proposed action consists of implementing the Site Plan, and includes of the incorporation of this Site Plan into LANL's Habitat Management Plan (HMP). The HMP was consulted upon in 1999 (Consultation #2-22-981-336) as the primary mechanism to ensure compliance with the ESA at LANL. The actions described in the Site Plan and analyzed in the BA, and supplemental emails are hereby incorporated by reference. You determined that implementing the Site Plan "may affect, is not likely to adversely affect" the salamander, and includes placing restrictions on certain types of work in areas identified as core habitat for the salamander on LANL property with the purpose of ensuring that effects to the salamander from those actions identified in the Site Plan are insignificant and discountable.

The Site Plan does not include any areas within designated salamander critical habitat, indicating that no critical habitat will be affected. The Site Plan has modeled and field validated the model to identify the areas on LANL property with the highest potential to be occupied by salamanders based on habitat features for the salamander. Each area identified by the modeling is termed "Area of Environmental Interest" (AEI) and consists of a "core area" and a "buffer area". The core area habitat is defined as suitable habitat where the salamander occurs or may occur at LANL. The core area habitat consists of sections of north-facing slope that contain the required

micro-habitat to support salamanders. The buffer area is 328 feet (100 meters) wide extending outward from the edge of the core area. Only the Los Alamos Canyon AEI is known to be occupied based on surveys. Surveys for the salamander are known to have a very low detection rate for occupied areas and DOE has assumed that all AEIs at LANL are occupied at all times by the salamander.

Within the Site Plan, DOE has assessed activities that could cause habitat alteration and includes any action that alters the soil structure, vegetative components necessary to the species, water quality, or hydrology in undeveloped areas of an AEI. If an activity were to take place outside of the AEI the activity will be assessed if it will have effects inside the AEI core. Within the core areas, only activities specified within the Site Plan and those that have no effect in the core areas (e.g. no habitat alterations or effects within the core areas) will be conducted without further consultation with the Service. Habitat alterations also include soil pits for soil samples deeper than 6 inches (15.2 centimeters) using either hand or mechanized augers. Within the Site Plan, DOE is proposing fuels management practices to reduce wildfire risk and maintenance of utility corridors within the AEIs. The likelihood that salamanders may be affected by the actions in the Site Plan is very low. To ensure that effects to the salamander are insignificant and discountable, the Site Plan incorporates the following conservation measures as restrictions to the identified work:

Fuels Management Practices to Reduce Wildfire Risk

- a. Within undeveloped core areas, thinning trees to a level of 80% canopy cover or higher may occur; tree thinning below 80% canopy cover is not part of the action under this consultation.
- b. Large logs on the ground will be left in place and not chipped.
- c. Large trees that are felled will be left as large logs on the ground
- d. When appropriate, smaller trees and understory shrubs that may be thinned will be dispersed and left on-site to aid in soil moisture retention.
- e. In buffer areas, thinning of trees may occur to the current LANL-approved prescription level; clear-cutting will not occur.
- f. Thinning activities will not occur during the rainy season when salamanders are surface active, between July 1 – October 31. Thinning activities may occur earlier in October if freezing temperatures are present.
- g. In the unlikely event that a salamander is observed surface active during thinning activities, all activities shall cease, and the Service will be notified.

Utility Corridors

- a. Cutting trees that threaten power lines may occur within 26 feet (8 meters) of either side of an existing utility line at LANL
- b. New utility lines and utility lines requiring clearance of a right-of-way greater than 52 feet (16 meters) total in core habitat is not part of the action under this consultation.

Habitat alterations other than the fuels management practices and utility corridor maintenance described above will not occur in undeveloped core areas under the guidelines of the Site Plan or this consultation. The Service concurs with DOE's determination regarding the salamander for the following reasons:

Within the Site Plan, DOE has placed the above detailed restrictions to ensure that any effects to the salamander and its habitat remain insignificant and discountable. Canopy cover will remain at 80% or greater in undeveloped core areas and fire management actions will occur outside of the salamander surface activity period. Maintaining utility line corridors in areas with existing infrastructure (the utility lines) by removing individual hazard trees is not expected to have any measurable effect on salamanders or their potential habitat. Consequently, we concur that potential effects to the salamander from the proposed action will be insignificant and discountable.

This concludes section 7 consultation regarding the proposed action. If monitoring or other information results in modification or the inability to complete all aspects of the proposed action, consultation should be reinitiated. Please contact the Service if: 1) future surveys detect listed, proposed or candidate species in habitats where they have not been previously observed; 2) the proposed action changes or new information reveals effects of the proposal to listed species that have not been considered in this analysis; or 3) a new species is listed or critical habitat designated that may be affected by the action.

Thank you for your concern for endangered and threatened species and New Mexico's wildlife habitats. In future correspondence regarding this project, please refer to consultation #02ENNM00-2014-I-0014. If you have any questions, please contact Michelle Christman of my staff at (505) 761-4715.

Sincerely,

Wally Murphy
Field Supervisor

cc:

Wildlife Biologist, Cuba Ranger District, Cuba, NM (Attn: Ramon Borrego)
Director, New Mexico Department of Game and Fish, Santa Fe, New Mexico

K-3, TA-3 and TA-60 IPac Trust Resource Report

MSGP

IPaC Trust Resource Report

Generated July 27, 2015 07:29 PM MDT



US Fish & Wildlife Service

IPaC Trust Resource Report



Project Description

NAME

MSGP

PROJECT CODE

LXATM-TI5EJ-BAJEQ-3NC5E-SOGYTE

LOCATION

Los Alamos County, New Mexico

DESCRIPTION

Facilities that discharge to Sandia Canyon within TA-3 and TA-60. Industrial facilities subject to the MSGP. July, 2015.

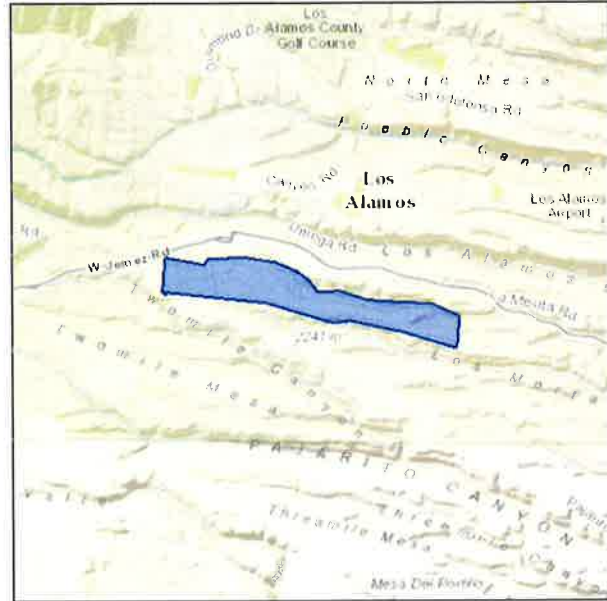

U.S. Fish & Wildlife Contact Information

Species in this report are managed by:

New Mexico Ecological Services Field Office

2105 Osuna Road Ne

Albuquerque, NM 87113-1001

(505) 346-2525

Endangered Species

Proposed, candidate, threatened, and endangered species that are managed by the [Endangered Species Program](#) and should be considered as part of an effect analysis for this project.

This unofficial species list is for informational purposes only and does not fulfill the requirements under [Section 7](#) of the Endangered Species Act, which states that Federal agencies are required to "request of the Secretary of Interior information whether any species which is listed or proposed to be listed may be present in the area of a proposed action." This requirement applies to projects which are conducted, permitted or licensed by any Federal agency.

A letter from the local office and a species list which fulfills this requirement can be obtained by returning to this project on the IPaC website and requesting an Official Species List from the regulatory documents section.

Amphibians

Jemez Mountains Salamander *Plethodon neomexicanus* **Endangered**

CRITICAL HABITAT

There is **final** critical habitat designated for this species.

<https://ecos.fws.gov/speciesProfile/profile/speciesProfile.action?scode=D019>

Birds

Mexican Spotted Owl *Strix occidentalis lucida* **Threatened**

CRITICAL HABITAT

There is **final** critical habitat designated for this species.

<https://ecos.fws.gov/speciesProfile/profile/speciesProfile.action?scode=B074>

Southwestern Willow Flycatcher *Empidonax traillii extimus* **Endangered**

CRITICAL HABITAT

There is **final** critical habitat designated for this species.

<https://ecos.fws.gov/speciesProfile/profile/speciesProfile.action?scode=B094>

Yellow-billed Cuckoo *Coccyzus americanus* **Threatened**

CRITICAL HABITAT

There is **proposed** critical habitat designated for this species.

<https://ecos.fws.gov/speciesProfile/profile/speciesProfile.action?scode=B06R>

Mammals

New Mexico Meadow Jumping Mouse *Zapus hudsonius luteus* **Endangered**

CRITICAL HABITAT

There is **proposed** critical habitat designated for this species.

<https://ecos.fws.gov/speciesProfile/profile/speciesProfile.action?scode=A0BX>

Critical Habitats

Potential effects to critical habitat(s) within the project area must be analyzed along with the endangered species themselves.

There is no critical habitat within this project area

Migratory Birds

Birds are protected by the [Migratory Bird Treaty Act](#) and the Bald and Golden Eagle Protection Act.

Any activity which results in the take of migratory birds or eagles is prohibited unless authorized by the U.S. Fish and Wildlife Service (1). There are no provisions for allowing the take of migratory birds that are unintentionally killed or injured.

You are responsible for complying with the appropriate regulations for the protection of birds as part of this project. This involves analyzing potential impacts and implementing appropriate conservation measures for all project activities.

Bald Eagle <i>Haliaeetus leucocephalus</i> Season: Wintering https://ecos.fws.gov/speciesProfile/profile/speciesProfile.action?spcode=B008	Bird of conservation concern
Bendire's Thrasher <i>Toxostoma bendirei</i> Season: Breeding	Bird of conservation concern
Brewer's Sparrow <i>Spizella breweri</i> Season: Migrating https://ecos.fws.gov/speciesProfile/profile/speciesProfile.action?spcode=B0HA	Bird of conservation concern
Brown-capped Rosy-finch <i>Leucosticte australis</i> Season: Wintering	Bird of conservation concern
Burrowing Owl <i>Athene cucularia</i> Season: Breeding	Bird of conservation concern
Cassin's Finch <i>Carpodacus cassinii</i> Year-round	Bird of conservation concern
Flammulated Owl <i>Otus flammeolus</i> Season: Breeding https://ecos.fws.gov/speciesProfile/profile/speciesProfile.action?spcode=B0DK	Bird of conservation concern
Fox Sparrow <i>Passerella iliaca</i> Season: Wintering	Bird of conservation concern
Golden Eagle <i>Aquila chrysaetos</i> Year-round https://ecos.fws.gov/speciesProfile/profile/speciesProfile.action?spcode=B0DV	Bird of conservation concern
Grace's Warbler <i>Dendroica graciae</i> Season: Breeding	Bird of conservation concern
Juniper Titmouse <i>Baeolophus ridgwayi</i> Year-round	Bird of conservation concern
Lewis's Woodpecker <i>Melanerpes lewis</i> Year-round	Bird of conservation concern
Loggerhead Shrike <i>Lanius ludovicianus</i> Year-round https://ecos.fws.gov/speciesProfile/profile/speciesProfile.action?spcode=B0FY	Bird of conservation concern

- Mountain Plover** *Charadrius montanus* **Bird of conservation concern**
Season: Breeding
<https://ecos.fws.gov/speciesProfile/profile/speciesProfile.action?spcode=B078>
- Olive-sided Flycatcher** *Contopus cooperi* **Bird of conservation concern**
Season: Breeding
<https://ecos.fws.gov/speciesProfile/profile/speciesProfile.action?spcode=B0AN>
- Peregrine Falcon** *Falco peregrinus* **Bird of conservation concern**
Season: Breeding
<https://ecos.fws.gov/speciesProfile/profile/speciesProfile.action?spcode=B0FU>
- Pinyon Jay** *Gymnorhinus cyanocephalus* **Bird of conservation concern**
Year-round
- Prairie Falcon** *Falco mexicanus* **Bird of conservation concern**
Year-round
<https://ecos.fws.gov/speciesProfile/profile/speciesProfile.action?spcode=B0ER>
- Swainson's Hawk** *Buteo swainsoni* **Bird of conservation concern**
Season: Breeding
<https://ecos.fws.gov/speciesProfile/profile/speciesProfile.action?spcode=B070>
- Williamson's Sapsucker** *Sphyrapicus thyroideus* **Bird of conservation concern**
Season: Breeding
<https://ecos.fws.gov/speciesProfile/profile/speciesProfile.action?spcode=B0FX>
- Willow Flycatcher** *Empidonax traillii* **Bird of conservation concern**
Season: Breeding
<https://ecos.fws.gov/speciesProfile/profile/speciesProfile.action?spcode=B0F6>

Refuges

Any activity proposed on National Wildlife Refuge lands must undergo a 'Compatibility Determination' conducted by the Refuge. If your project overlaps or otherwise impacts a Refuge, please contact that Refuge to discuss the authorization process.

There are no refuges within this project area

Wetlands

Impacts to NWI wetlands and other aquatic habitats from your project may be subject to regulation under Section 404 of the Clean Water Act, or other State/Federal Statutes.

Project proponents should discuss the relationship of these requirements to their project with the Regulatory Program of the appropriate U.S. Army Corps of Engineers District.

DATA LIMITATIONS

The Service's objective of mapping wetlands and deepwater habitats is to produce reconnaissance level information on the location, type and size of these resources. The maps are prepared from the analysis of high altitude imagery. Wetlands are identified based on vegetation, visible hydrology and geography. A margin of error is inherent in the use of imagery; thus, detailed on-the-ground inspection of any particular site may result in revision of the wetland boundaries or classification established through image analysis.

The accuracy of image interpretation depends on the quality of the imagery, the experience of the image analysts, the amount and quality of the collateral data and the amount of ground truth verification work conducted. Metadata should be consulted to determine the date of the source imagery used and any mapping problems.

Wetlands or other mapped features may have changed since the date of the imagery or field work. There may be occasional differences in polygon boundaries or classifications between the information depicted on the map and the actual conditions on site.

DATA EXCLUSIONS

Certain wetland habitats are excluded from the National mapping program because of the limitations of aerial imagery as the primary data source used to detect wetlands. These habitats include seagrasses or submerged aquatic vegetation that are found in the intertidal and subtidal zones of estuaries and nearshore coastal waters. Some deepwater reef communities (coral or tubercid worm reefs) have also been excluded from the inventory. These habitats, because of their depth, go undetected by aerial imagery.

DATA PRECAUTIONS

Federal, state, and local regulatory agencies with jurisdiction over wetlands may define and describe wetlands in a different manner than that used in this inventory. There is no attempt, in either the design or products of this inventory, to define the limits of proprietary jurisdiction of any Federal, state, or local government or to establish the geographical scope of the regulatory programs of government agencies. Persons intending to engage in activities involving modifications within or adjacent to wetland areas should seek the advice of appropriate federal, state, or local agencies concerning specified agency regulatory programs and proprietary jurisdictions that may affect such activities.

There are no wetlands identified in this project area

APPENDIX L

Procedures Referenced in the SWPPP

ENV-CP-QP-007

Revision: 10



Effective Date: 09/30/15

Next Review Date: 09/30/18

Environment, Safety, Health Directorate

Environmental Protection – Compliance Programs

Quality Procedure

Spill Investigations

Reviewers:

Name: Brian M. Iacona	Organization: ENV-CP	Signature: Signature on File	Date: 08/13/15
Name: Jacob W. Meadows	Organization: ENV-CP	Signature: Signature on File	Date: 08/28/15

Derivative Classifier: Unclassified DUSA ENVPRO

Name: Gian A. Bacigalupa	Organization: ENV-CP	Signature: Signature on File	Date: 08/31/15
-----------------------------	-------------------------	---------------------------------	-------------------

Approval Signatures:

Subject Matter Expert: Jacob W. Meadows	Organization: ENV-CP, Program Lead	Signature: Signature on File	Date: 08/31/15
Responsible Line Manager: Michael T. Saladen	Organization: ENV-CP, Team Leader	Signature: Signature on File	Date: 08/31/15
Responsible Line Manager: Anthony R. Grieggs	Organization: ENV-CP, Group Leader	Signature: Signature on File	Date: 09/30/15

This copy is uncontrolled.

*Users are responsible for ensuring they work to the latest approved version.
To document a required read, Login to [UTrain](#), and go to the Advanced Search.*

Spill Investigations	ENV-CP-QP-007	Page 2 of 12
	Revision: 10	Effective Date: 09/30/15

History of Revisions

Document Number <i>[Include revision number, beginning with Revision 0]</i>	Effective Date <i>[Document Control Coordinator inserts effective date]</i>	Description of Changes <i>[List specific changes made since the previous revision]</i>
0	12/98	New Document.
1	06/00	Annual review, added Cerro Grande fire hazards
2	07/01	Annual review
3	06/03	Annual review
4	04/04	Annual review, changes to HCPs
5	02/07	Annual review, changes to reflect organizational restructure
6	07/08	Annual review
7	09/10	Biennial Review and revision
8	04/11	Removed prerequisites, added note re: on-call spill reporting.
9	07/13	Biennial review and revision, implemented new procedure format.
10	09/30/15	Biennial review and revision, implemented new procedure format. Controlled the updated LANL ENV-CP Unplanned Release Report.

Spill Investigations	ENV-CP-QP-007	Page 3 of 12
	Revision: 10	Effective Date: 09/30/15

Table of Contents

1.0 PURPOSE 4

2.0 SCOPE..... 4

 2.1 Hazard review 4

3.0 RESPONSIBILITIES..... 4

 3.1 Prerequisites 4

4.0 WORK PROCESSES..... 4

 4.1 Field Activity 5

 4.2 Communication 6

 4.3 Facility Management Work Control Requirements for Field Activities 6

 4.4 Facility Management-Specific Access Requirements..... 6

 4.5 Regulatory Spill Reporting..... 8

5.0 DOCUMENT CONTROL/RECORDS MANAGEMENT 8

6.0 DEFINITIONS 9

7.0 REFERENCES..... 9

8.0 ATTACHMENTS 9

 Attachment 1- ENV-CP Release Notification Phone List 10

 Attachment 2- LANL ENV-CP Unplanned Release Report..... 12

Spill Investigations	ENV-CP-QP-007	Page 4 of 12
	Revision: 10	Effective Date: 09/30/15

1.0 PURPOSE

This Environmental Protection Division – Compliance Programs Group (ENV-CP) procedure describes processes and implements requirements for spill investigations.

2.0 SCOPE

This procedure applies to all ENV-CP staff and personnel conducting spill investigations.

2.1 HAZARD REVIEW

The work described in this procedure is field work and has a **LOW hazard** rating as documented by submittal of a completed [ENV Low Hazard Verification form](#).

3.0 RESPONSIBILITIES

The following personnel require training before implementing this procedure:

- ENV-CP staff and contract personnel who perform spill response and investigation.

Annual re-training to this procedure is required. Specific training requirements will be updated as needed.

The training method for this procedure is required reading and on-the-job training (OJT). The OJT is to be conducted by a Team Leader or person designated as Subject Matter Expert (SME) by the ENV-CP Group Leader. This training will be documented in accordance with [ENV-DO-QP-115, Personnel Training](#).

Actions specified within this procedure, unless proceeded with “should” or “may,” are to be considered mandatory (i.e., “shall”, “will”, “must”).

3.1 PREREQUISITES

None

4.0 WORK PROCESSES

Responsibility is to assure the immediate mitigation and timely notification of appropriate regulatory organizations in the event of a spill or unplanned discharge that has or may affect the environment. Work requires frequent and unscheduled site visits to any area of the Laboratory during a spill or unplanned release as support staff for the on-scene Security and Emergency Operations (SEO) Incident Commander.

Specific activities associated with Spill Response and Investigation:

- Respond to the spill or unplanned release site;
- Report to the On-Scene SEO Incident Commander and Site Safety Officer;
- Receive site safety requirements;
- Provide decision support;
- Investigate the nature and extent of the spill or unplanned release;

Spill Investigations	ENV-CP-QP-007	Page 5 of 12
	Revision: 10	Effective Date: 09/30/15

- Evaluate the potential environmental impact to water quality;
- Report the occurrence to the regulatory agencies, if necessary; and
- Provide support to mitigation plan and implementation.

4.1 FIELD ACTIVITY

If the spill or unplanned discharge is determined to be a non-emergency event by SEO response, such as a release of potable water, perform the following steps:

Step	Action
1	Perform a site visit in coordination with the Facility Operations Director designee.
2	Assess potential environmental damage.
3	Provide mitigation measures and requirements.
4	Document the event.
5	Notify regulatory agencies and DOE, if necessary.
6	Facilitate collection of samples, if necessary.

For emergency response, perform the following steps:

Step	Action
1	Report to on-scene commander and await instructions.
2	Perform a site visit in coordination with SEO.
3	Adhere to access requirements as developed by the SEO Site Safety Officer and Incident Commander.
4	Identify and document the source and cause of the release.
5	Provide notification and written report if necessary.
6	Facilitate collection of samples if necessary and safe to do so.

If sample collection is required, contact the following sampling personnel:

- ENV-CP
 - NPDES outfall
 - Sanitary treatment solids
- WM-SVS
 - Wastes and chemical spills (liquid, solid, hazardous)
- ADEP Environmental Remediation Division
 - Surface water
 - Storm water runoff
 - Groundwater
 - Sediments

Spill Investigations	ENV-CP-QP-007	Page 6 of 12
	Revision: 10	Effective Date: 09/30/15

If WM-SVS will collect the required sample, complete a Request For Analysis (RFA), <http://int.lanl.gov/environment/waste/sampling.shtml>, to schedule sampling. Specify the analytical suite and turn-around time needed for the sample in the RFA.

4.2 COMMUNICATION

Take a cellular phone that will transmit from the location to be visited. Also take a contact pager to receive messages.

If cellular service is unavailable, use a portable radio set to the appropriate radio frequency.

If in a secure area where cell phone use is prohibited, use the radio. Be sure to have radio checked and authorized for use within secure areas or within the boundaries of the WFO FOD or WX Division. Government-owned cellular phones, with batteries removed, may be brought into the secure area but used only if approval is given by the SEO Incident Commander or FOD or designee. Rules of use for Smartphones and other mobile devices (BlackBerry, iPhones, iPads) can be found on the Computing Communications webpage for mobile devices, <http://int.lanl.gov/computing/communications/mobile/index.shtml>.

Radio or cellular contact must be established with a designated contact prior to leaving ENV-CP and upon arrival/departure at the site in accordance with [ENV-DO-QP-100, General Field Safety](#).

The Incident Commander can make special communication exceptions.

All photography at LANL must adhere to [P217, Controlled Articles](#).

Wastes generated from activities described in the procedure will be properly characterized, managed, and disposed in accordance with [P409, LANL Waste Management](#), [P930-1, LANL Waste Acceptance Criteria](#), and [P403, Environmental Risk Identification and Management](#).

4.3 FACILITY MANAGEMENT WORK CONTROL REQUIREMENTS FOR FIELD ACTIVITIES

Most field activities performed by the ENV-CP spill response personnel are impacted by facility management work control requirements. Requirements vary between the respective Facility Operations Divisions (FODs) and therefore necessitate ENV-CP response personnel to acquire FOD approval for site access in advance of starting work activities. The exception to this is in response to emergency situations as support to SEO staff.

Should work be required to stop/pause, reference [P101-18, Procedure for Pause/Stop Work](#), for guidance.

4.4 FACILITY MANAGEMENT-SPECIFIC ACCESS REQUIREMENTS

4.4.1 HIGH EXPLOSIVES AREAS

TA-16 and TA-11 high explosives areas have specific access requirements. Access inside the security gate requires annual site-specific training. Curricula #5243 must be assigned and all the training courses completed before arriving at TA-16. For access, (normal or after hours) contact the WFO FOD to ensure entry requirements are met and the activity is authorized for the Plan of the Day.

Spill Investigations	ENV-CP-QP-007	Page 7 of 12
	Revision: 10	Effective Date: 09/30/15

For access to WFO perimeter gates during normal working hours or after hours, contact TA-15 Access Control at 667-6742 and request permission to enter. A perimeter gate key must be picked up at the TA-15 Access Control office. Note that all outdoor firing will be suspended during entry.

For perimeter gates, prior notification for after-hours entry is also required by SOC. Perform the following steps:

Step	Action
1	Call SOC Los Alamos at 667-4437.
2	Identify yourself to the on duty officer or attendant.
3	Provide the following information: Group, color and make of vehicle (s), which perimeter gate you are entering, and approximate time of arrival and finally, length of stay.

Failure to notify security personnel in advance could result in a security violation against the visiting Team Member.

Provide notification to SOC Los Alamos at 667-4437 when leaving area.

For access to WX areas required during normal or after working hours, perform the following steps:

- Ensure the required security clearance (Q clearance) is held, and
- Contact the FOD or designee for entry requirements.

4.4.2 CHEMISTRY METALLURGY RESEARCH FACILITY ACCESS

For access to the Chemistry Metallurgy Research Facility, perform the following:

- Must have the required L or Q clearance to pass the security gate.
- If access into any of the buildings is necessary, contact CMR Operations Management or the FOD for an escort.
- If responding to an emergency with SEO, ENV-CP staff will be considered part of the SEO response team, met at the access gate, and escorted to the spill site.

4.4.3 TA-3-66 SIGMA FACILITY ACCESS

For access to the Sigma facility (TA-3-66), perform the following:

- For non-emergency responses, obtain prior site-specific training and authorization or contact the FOD for personnel escort and contact the FOD Deployed Environmental Professional.
- For emergency response with SEO, ENV-CP staff will be considered part of the SEO response team, met at the access gate, and escorted to the spill site. Contact the FOD to ensure they are aware of the incident.

4.5 REGULATORY SPILL REPORTING

If a spill is determined to be a threat to the environment or human health, regulatory and DOE notification may be necessary. Contacts and telephone numbers can be found on Attachment 1, ENV-CP Release Notification Phone List.

If a spill impacts a Solid Waste Management Unit (SWMU) or Area of Concern (AOC), contact ENV-CP and Environmental Remediation (ER) for possible additional notification requirements.

If ENV Division or designated SME personnel determine after a site inspection or verbal notification that a spill is non-reportable to DOE or applicable regulatory agencies, a LANL ENV-CP Unplanned Release Report must be completed (Attachment 2) and submitted to the ENV-CP SME for required documentation.

For ENV Division designated on-call personnel, follow guidance for spill reporting as described in [ENV-DO-QP-101, *Environmental Reporting Requirements for Releases or Events*](#).

NOTE: On-call representatives are required to follow up in writing (email is sufficient) with the spills program lead regarding all releases during their on-call schedule. If no spills are reported in off-work hours, please confirm in writing with the spills program lead at the end of your on-call schedule.

For additional information concerning spill and unplanned discharge determination and notification requirements, contact the ENV-CP Water Quality Permitting and Compliance Team Leader.

5.0 DOCUMENT CONTROL/RECORDS MANAGEMENT

The following records generated as a result of this procedure are to be submitted in accordance with [ADESH-AP-006 Records Management Plan](#).

- Field notebook documentation of the release including:
 - Time and date of the release
 - Time and date of ENV-CP notification
 - Location of the release
 - Source of the release(equipment, etc,)
 - Type of material released
 - Quantity of material released
 - If an impact to a watercourse or Potential Release Site occurred
 - Time release was stopped
 - Any immediate mitigating actions implemented to contain or control the release
- Any written report and verbal notification list generated should the release be deemed reportable.
- LANL ENV-CP Unplanned Release Report (Attachment 2) for non-reportable releases.

Spill Investigations	ENV-CP-QP-007	Page 9 of 12
	Revision: 10	Effective Date: 09/30/15

6.0 DEFINITIONS

AOC: Area of Concern

ER: Environmental Remediation

Field Work: Performance of Laboratory related activities in areas that are removed or isolated from an established populated base of operation (that is, where emergency support and medical assistance is not readily available.)

FOD: Facility Operations Division

NPDES: National Pollutant Discharge Elimination System

OJT: On the job training

PRS: Potential Release Site

SEO: Security and Emergency Operations

SOC Los Alamos: Security contractor for Los Alamos National Laboratory

SWMU: Solid Waste Management Unit

7.0 REFERENCES

None

8.0 ATTACHMENTS

Attachment 1- ENV-CP Release Notification Phone List

Attachment 2- LANL ENV-CP Unplanned Release Report

ATTACHMENT 1- ENV-CP RELEASE NOTIFICATION PHONE LIST

Los Alamos National Laboratory

ENV-CP

Release notification phone list

August 2015

Los Alamos National Laboratory

- | | |
|------------------------------------------------------------------------|----------------------|
| (1) Security and Emergency Operations
Emergency Management (SEO-EM) | 667-6211 |
| (2) ENV-ES Group Office | 665-8855 |
| (3) ENV-CP Group Office | 667-0666 |
| (4) ENV-DO | 667-2211 |
| (5) LANL Central Alarm Station (SOC-LA)
L.A. Fire Department | 667-7080
667-4055 |

New Mexico Environment Department

See Web address below

- | | |
|------------------------------------------------------------------------------------------------------------------|----------------------------------------------|
| (1) NMED Emergency Hotline (24 hours a day) | 827-9329 |
| (2) NMED Non-Emergency Hotline (During business hours)
NMED Non-Emergency Hotline (Voicemail; 24 hours a day) | 476-6000
1(866) 428-6535 |
| (3) NMED Surface Water Quality Bureau
Erin Trujillo | 827-0187
827-0418 |
| (4) NMED Ground Water Quality Bureau
Greg Huey
Steven Huddleson
Gerald Knutson | 827-2900
827-6891
827-2936
827-2996 |
| (5) NMED Hazardous Waste Bureau
Ruth Horowitz | 476-6000
476-6025 |

U.S Environmental Protection Agency

- | | |
|---------------------------------------------------------------------------------------------|------------------------------------|
| (1) US EPA Region 6 Spill Reporting (During business hours)
Emergencies- Contact the NRC | 1(800) 887-6063
1(800) 424-8802 |
| (2) Gladys Gooden-Jackson | 1(214) 655-7494 |

U.S. Department of Energy

- | | |
|-----------------|----------|
| (1) Gene Turner | 667-5794 |
|-----------------|----------|

State Emergency Response Commission (SERC) Notification

- | | |
|-------------------------------------------------------------------------------------------------|---------------------------------------------------------------------------|
| New Mexico State Police
(Immediate Notification) | (505) 827-9300 (During business hours)
(505) 827-3476 (24 hours a day) |
| New Mexico Department of Homeland Security and Emergency
Management (Follow-up Notification) | (505) 476-9600 |

National Response Center

- | | |
|----------------------------------------------------------------------------------------|----------------|
| U.S. Coast Guard National Response Center
See NRC web address below for report form | 1-800-424-8802 |
|----------------------------------------------------------------------------------------|----------------|

Spill Investigations	ENV-CP-QP-007	Page 11 of 12
	Revision: 10	Effective Date: 09/30/15

New Mexico State Police

New Mexico State Police

(505)827-9300 (During business hours)

(505) 827-3476 (24 hours a day)

Local Emergency Planning Committee (LEPC) LAPD

Philmont Taylor

(505) 663-3511

On Call Environmental Contact for Releases
Group Representatives for Notifications to External Agencies

Name	Group	Work Phone	Pager	Cellular Phone	Email address
Jake Meadows	ENV-CP	606-0185	664-1333	231-0460	jmeadows@lanl.gov
Mike Saladen	ENV-CP	665-6085		699-1284	saladen@lanl.gov
Mark Haagenstad	ENV-CP	665-2014		699-1733	mph@lanl.gov
Tim Zimmerly	ENV-CP	664-0105	664-1237	699-7621	tzimmer@lanl.gov
Terrill Lemke	ENV-CP	665-2397		699-0725	tlemke@lanl.gov

Web addresses:

NMED home page <http://www.nmenv.state.nm.us>

National Response Center home page <http://www.nrc.uscg.mil/Default.aspx>

Reportable Quantities web page <http://homer.ornl.gov/rg/>

ATTACHMENT 2- LANL ENV-CP UNPLANNED RELEASE REPORT

**Los Alamos National Laboratory
Environmental Compliance Programs (ENV-CP)
Unplanned Release Report**

Form Completed By:		Telephone:	Group:
Spill Details		Spill Owner (Specify): <input type="checkbox"/> LANL, LLC <input type="checkbox"/> Subcontractor:	
Date of Spill/Date Spill Discovered:			
Location:			
Material Spilled:		<input type="checkbox"/> Anti-freeze/coolant	<input type="checkbox"/> Gasoline
<input type="checkbox"/> Hydraulic Fluid		<input type="checkbox"/> Steam Condensate	<input type="checkbox"/> Other: _____
<input type="checkbox"/> Potable Water		<input type="checkbox"/> Lubricants/oils	
<input type="checkbox"/> Diesel		<input type="checkbox"/> Refrigerant Oil	
Volume Spilled:		Waste Volume Generated:	
Source of Spill:		<input type="checkbox"/> Hydraulic Line	<input type="checkbox"/> Radiator
Vehicle ID: _____		<input type="checkbox"/> Potable Water Line	<input type="checkbox"/> Condensate Line
Equipment ID: _____		<input type="checkbox"/> Fire Suppression System	<input type="checkbox"/> Other: _____
		<input type="checkbox"/> Fuel Tank	
Describe the spill response in chronological order. Include response personnel, steps taken to contain the spill, and steps/spill control equipment used to clean it up. Please indicate if corrective actions have been completed and describe actions taken to prevent spill recurrence:			
Date Corrective Actions Completed: _____			
Did the spill enter or impact any of the following? (Check as many as apply)		<input type="checkbox"/> Floor Drain, if so please indicate affected facility	
<input type="checkbox"/> RCRA Treatment Storage Disposal Facility		<input type="checkbox"/> Watercourse/drainage area, if so please indicate	
<input type="checkbox"/> RCRA Satellite Accumulation Area		<input type="checkbox"/> Solid Waste Management Unit/Area of Concern, if so please indicate	
<input type="checkbox"/> RCRA <90 Day Storage Area		<input type="checkbox"/> None	
Did the spill occur inside or outside a building?		<input type="checkbox"/> Inside	<input type="checkbox"/> Outside
Did the spill occur on:		<input type="checkbox"/> Concrete	<input type="checkbox"/> Asphalt
(Check as many as apply)		<input type="checkbox"/> Carpeted Floor	<input type="checkbox"/> Graveled/Rocky Area
		<input type="checkbox"/> Tile	<input type="checkbox"/> Soil/Vegetated Area
		<input type="checkbox"/> Wooden floor/deck	<input type="checkbox"/> Other: _____
Samples Collected:		If samples were collected, indicate analytical suite:	
<input type="checkbox"/> None	<input type="checkbox"/> Soil		
<input type="checkbox"/> Water	<input type="checkbox"/> Air		
	<input type="checkbox"/> Other: _____		
Certification			
I certify that I am knowledgeable about the information on this form. The information, to my knowledge, is true, accurate, and complete.			
Name of Certifying Official:		Organization:	Date:
Certification:			
Completed by ENV-CP Personnel		<input type="checkbox"/> Non-Reportable	
Date Received:	Severity Index:	Causal Analysis:	<input type="checkbox"/> Reportable

ENV-DO-QP-101.2



Effective Date: June 12, 2012

Next Review Date: May 12, 2014

Environment, Safety, Health Directorate

Environmental Protection – Division Office

Quality Procedure

Title: Environmental Reporting Requirements for Releases or Events

Reviewers:

Name: Melanie Lamb	Organization: ENV- QPMO, QA Specialist	Signature: Signature on file	Date: 6/1/12
-----------------------	-------------------------------------------	---------------------------------	-----------------

Derivative Classifier: **Unclassified**

Name: Anthony Grieggs	Organization: ENV-RCRA	Signature: Signature on file	Date: 6/7/12
--------------------------	---------------------------	---------------------------------	-----------------

Approval Signatures:

Responsible Line Manager: Anthony Grieggs	Organization: ENV-RCRA, Group Leader	Signature: Signature on file	Date: 6/7/12
Responsible Line Manager: Tina Marie Sandoval	Organization: ENV-QPMO, Office Leader	Signature: Signature on file	Date: 6/4/12
Responsible Line Manager: Alison M. Dorries	Organization: ENV-DO, Division Leader	Signature: Signature on file	Date: 6/12/12

CONTROLLED DOCUMENT

This copy is uncontrolled. The controlled copy can be found on the ENV Division Webpage. Users are responsible for ensuring they work to the latest approved version.

Title: Environmental Reporting Requirements for Releases or Events	ENV-DO-QP-101.2	Page 2 of 24
	Effective Date: June 12, 2012	

History of Revisions

Document Number <i>[Include revision number, beginning with Revision 0]</i>	Effective Date <i>[Document Control Coordinator inserts effective date]</i>	Description of Changes <i>[List specific changes made since the previous revision]</i>
0	02/09	New document
1	4/10	Revision and update
2	6/12	Biennial Review/Revision, new template implemented.

Table of Contents

1.0	PURPOSE	4
2.0	SCOPE	4
2.1	Work hazard analysis	4
3.0	RESPONSIBILITIES/PREREQUISTIES	4
3.1	Prerequisites	4
4.0	DOCUMENT CONTROL/RECORDS MANAGEMENT	5
5.0	WORK PROCESSES	5
5.1	Responsibility of on-call representative.....	5
5.2	Follow-up reporting	6
5.3	Summary of Policy on reporting	6
5.4	Using this procedure	7
5.5	Determining if a release is reportable under RCRA	7
5.6	Determining if a release is reportable under TSCA.....	8
5.7	Determining if a release is reportable under CWA or NM Water Quality Act.....	9
5.8	Determining if a release is reportable under CERCLA or EPCRA	11
5.9	Determining if a release is reportable under Biological or Cultural Requirements.....	13
5.10	Reporting a Release or Event.....	14
6.0	REFERENCES	18
7.0	DEFINITIONS	19
8.0	ATTACHMENTS	20
	ATTACHMENT 1: Emergency Notification Requirements for RCRA.....	21
	ATTACHMENT 2: Summary of Emergency Release or Event Reporting Requirements.....	23

Title: Environmental Reporting Requirements for Releases or Events	ENV-DO-QP-101.2	Page 4 of 24
	Effective Date: June 12, 2012	

1.0 PURPOSE

This Environmental Protection Division (ENV-DO) procedure describes how to determine whether an unplanned release, spill, fire, or other event needs to be reported under environmental regulations and how to fulfill all immediate reporting requirements (within the first 24 hours). Emergency and abnormal event notification requirements for reporting to Laboratory and DOE management are specified in [PD1200, *Emergency Management*](#), and [P322-3, *Performance Improvement from Abnormal Events*](#). Environmental reporting requirements regarding releases or other events are included in this procedure.

2.0 SCOPE

This procedure applies to ENV-DO on-call representatives and subject matter experts (SMEs) who must respond to any release, spill, or event at the Laboratory that may require immediate notification to local, state or federal regulatory agencies or Pueblo Environmental Departments (refer to [ENV-DO-QP-111, *Reporting Environmental Releases To Pueblo Governments*](#)) and describes the actions that must be performed within the first 24 hours. This procedure does **not** cover the response procedures for “continuous releases” under CERCLA and EPCRA (see definitions) nor the follow-up notifications and reports.

2.1 WORK HAZARD ANALYSIS

The work described in this procedure consists of field work that does not require an Integrated Work Document (IWD) and is rated as having a **LOW hazard** level as documented by submittal of an [ENV Low Hazard Verification form](#) to the Quality Assurance Specialist.

3.0 RESPONSIBILITIES/PREREQUISITES

The following personnel require training before implementing this procedure:

- ENV-DO managers and designated on-call representatives and SMEs who may be asked to fulfill reporting requirements during release-related exercises or during actual releases, or within 24 hours.

Annual retraining to this procedure is required. This procedure will be reviewed biennially by all affected personnel and updated as necessary.

Training to this procedure will be by “self-study” (reading) and is documented in accordance with the trainee’s organization’s procedure for training.

3.1 PREREQUISITES

- None

Note: Actions specified within this procedure, unless preceded with “should,” or “may,” are to be considered mandatory (i.e., “shall,” “must,” “will”).

Title: Environmental Reporting Requirements for Releases or Events	ENV-DO-QP-101.2	Page 5 of 24
Effective Date: June 12, 2012		

4.0 DOCUMENT CONTROL/RECORDS MANAGEMENT

The following records generated as a result of this procedure are to be submitted as records according to the responder's group's internal records management process:

- Field documentation of the release, including:
 - Time and date of the release
 - Time, date, and description of notifications
 - Location and source of the release
 - Type of material released
 - Quantity of material released
 - Impacted media
 - Time release was stopped
 - Any immediate mitigation actions taken to contain or control the release
 - Documentation of any verbal notifications
 - Samples taken
- Copies of any written notifications generated
- Documentation of any analytical results, and quality assurance of results
- Any other contingency plan or emergency plan documentation
- Documentation of any PCB notification
- Documentation of any RCRA permit non-compliance that threatens human health and environment
- Documentation of treatment of any RCRA unstable chemicals, leaking or compromised gas cylinders

5.0 WORK PROCESSES

Events covered by this procedure include detonation or burns of unstable material, leaking or compromised gas cylinders, puncturing of bulging containers, fires, explosions, chemical or radiological spills inside or outside of buildings, wastewater spills, potable water or fire fighting water as well as impacts to cultural and biological resources not adequately documented, and other releases to the environment.

On a semi-annual basis ENV-DO will prepare a list of individuals designated as on-call representatives and will designate the week each will be on-call. This list will be distributed to on-call representatives and Laboratory managers including PADOPS, ADES&H, ADEP, Emergency Operations (ADSS-EO), ENV-DO, ENV-RCRA, and ENV-ES. The on-call representative can be reached by pager at 664-7722.

5.1 RESPONSIBILITY OF ON-CALL REPRESENTATIVE

The ENV on-call representative is the party primarily responsible for:

- determining if the incident will require immediate notification to external agencies in accordance with LANL, State, and Federal regulatory reporting requirements
- notifying ENV Division management of immediate reporting requirements; and

Title: Environmental Reporting Requirements for Releases or Events	ENV-DO-QP-101.2	Page 6 of 24
	Effective Date: June 12, 2012	

- if needed, coordinating with other on-call SMEs and the Emergency Operations Center (EOC) to ensure the required notifications for environmental reporting and abnormal events are being addressed for the Laboratory.

The ENV-DO on-call representative is not responsible for the following, EOC will make these determinations:

- determining if the RCRA Contingency Plan must be implemented, or
- if a shock-sensitive material or leaking or compromised gas cylinder constitutes an emergency.

However, in order to ensure that the appropriate expertise is available for the affected media, the ENV on-call representative may immediately confer with an SME of the ENV group that has programmatic responsibility. If an SME from the responsible group is able to respond to the event, the remaining steps in this procedure may be passed to that person.

A list of contact numbers for on-call representatives and SMEs for ENV groups (ES & RCRA) is available in the ENV-RCRA group office. The ENV-DO and ADSS-EO may also be contacted to determine the on-call representative for each group.

5.2 FOLLOW-UP REPORTING

This procedure describes the initial external notifications (within the first 24 hours) to regulatory agencies and Pueblo Environmental Departments. After completion of the steps in this procedure, the ENV group specifically responsible for compliance with the relevant regulations (responsible group) will complete the required notifications and reports, as applicable under the appropriate regulations, according to established procedures.

5.3 SUMMARY OF POLICY ON REPORTING

The ENV on-call representative and SMEs have the authority and responsibility for deciding when to report and for making the report to regulatory agencies within regulatory deadlines and to Pueblo Environmental Departments when potentially impacted.

LANL management and DOE LASO must be informed as soon as possible that a report was or will be made, but their approval is not required prior to the report being made to the regulatory agency or Pueblo. LANL management, with input from ENV SMEs, will determine if an ORPS (Occurrence Reporting Processing System) report or other type of Lessons Learned will be necessary.

NOTE: ADSS-EO maintains a current list of on-call LANL managers.

5.4 USING THIS PROCEDURE

This procedure has four separate paths (and corresponding sections) to follow for determining if a release or event is reportable. Follow each of these paths to determine if one or more are applicable:

- RCRA
- TSCA
- CWA, NM WQA, and NM WQCC Regulations
- CERCLA and EPCRA.
- CAA
- Endangered Species Act (ESA), New Mexico Endangered Plant Species Act
- Bald Eagle Protection Act, Migratory Bird Treaty Act
- New Mexico Wildlife Conservation Act
- National Environmental Policy Act (NEPA)
- National Historic Preservation Act (NHPA)
- Native American Graves Protection and Repatriation Act (NAGPRA)
- Archaeological Resources Protection Act (ARPA)

Under CERCLA or EPCRA, a Reportable Quantity (RQ) is the action level that may trigger an appropriate response to a release under the provisions of these regulations. A release may not meet RQ reporting limits **but still may be reportable** under RCRA and CWA requirements.

NOTE: The 24-hour deadline (15 minutes in some cases) applies regardless of whether it occurs during business hours, non-business days or after business hours.

Additional information and guidance on how and when to report a release is available at this link: <http://homer.ornl.gov/nuclearsafety/env/guidance/cercla/rqs-gen.pdf>.

All potential ENV-DO on-call representatives or SMEs should follow the various links at this site and be familiar with the guidance before any release or event occurs.

5.5 DETERMINING IF A RELEASE IS REPORTABLE UNDER RCRA

Follow the flow charts in Attachment 1 to determine if an event is reportable under RCRA. The three groups of circumstances described below (also delineated in the flow charts in Attachment 1) are evaluated to determine if an event is reportable.

Under the RCRA permit requirements, the ADSS-EO manager determines if the “RCRA Contingency Plan” provisions should be implemented. The flow chart in Attachment 1 starts with this determination. The ENV on-call representative or an ENV-RCRA SME performs notifications that are necessary.

The ADSS-EO Manager will normally attempt to contact the ENV-RCRA SME for guidance in making this decision. If the ENV-RCRA SME is successfully contacted, the completion of the remainder of this procedure may be passed on to this individual.

The ENV on-call representative makes the determination that one or more of these conditions occurred through consultation with ENV-RCRA and appropriate SMEs. 24-hour notification can be made by the on-call representative or by an SME of ENV-DO.

The EOC manager makes the determination that unstable chemicals, leaking or compromised gas cylinders represent an emergency situation and, typically with ENV-RCRA, how best to respond. 24-hour notification can be made by the on-call representative or ENV-RCRA SME.

If a release/event is reportable under RCRA rules, determine if the release/event is reportable under other rules and proceed to the section *Reporting a Release or Event*.

5.6 DETERMINING IF A RELEASE IS REPORTABLE UNDER TSCA

In practice, only spills of Polychlorinated Biphenyls (PCBs) or PCB-suspect untested mineral oil to the environment (generally outdoors or with the potential to reach the outdoors) are reportable. Spills that are contained indoors are generally not reported.

A release of PCB's is reportable to the EPA under TSCA if it is over 10 pounds PCB's by weight or at concentrations of 50 ppm or greater.

Follow the steps in *Determining if a Release is Reportable under CERCLA, EPCRA, or Other Regulations* to determine if the RQ (of 1 pound) for PCBs has been triggered. Additionally, reporting requirements are triggered if over 270 gallons of untested mineral oil suspected of containing PCBs has been spilled.

There are nine items containing PCBs that are in use at the CMR Building. In addition, there is one PCB contaminated transformer in use at TA-48. All other known PCB equipment at the Laboratory has been taken out of service and disposed of in accordance with TSCA regulations.

If a release (see definitions) is reportable under TSCA, continue through the next sections to determine if the release/event is reportable under other rules and proceed to *Reporting a Release or Event* and determine if additional reporting is necessary (below).

If the spill is ...	Then...
over 10 pounds by weight of PCBs (TSCA)	Report to EPA Region 6 (Office of Prevention, Pesticides and Toxic Substances Branch) through EPA's 24-hour spill response number 866-372-7745 as soon as possible after discovery but no later than 24 hours after discovery.
OR if PCBs are at concentrations ~50 ppm that directly contaminate surface water sewers, drinking water supplies, grazing lands, or vegetable gardens	

5.7 DETERMINING IF A RELEASE IS REPORTABLE UNDER CWA OR NM WATER QUALITY ACT

The CWA and NM Water Quality Act (NMWQA) (equivalent to the national Clean Water Act) does not use RQs (as described in the next section). Instead the NM Water Quality Control Commission (NMWQCC) regulations state: *“Any amount of any material in such quantity as may with reasonable probability injure or be detrimental to human health, animal or plant life, or property, or may unreasonably interfere with the public welfare or the use of property. This includes chemical, biohazardous, petroleum-product, and sewage spills and incidents. In addition to recent spills, the discovery of evidence of previous unauthorized discharges, such as contaminated soil or ground water, also must be reported.”*

The above rule requires the use of professional judgment to determine if reporting is required. No quantifiable metric is available to assist in making this determination, however. The ENV on-call representative or SME has the authority and responsibility to make this determination.

Spills of potable water or fire fighting water (e.g., water line breaks) require reporting if there is a release of over 5000 gallons or if the release impacts a Solid Waste Management Unit (SWMU). Contact the ADEP for the location of SWMUs and coordinate any necessary water quality notifications with ENV-RCRA.

For oil discharges (film/sheen/dicoloration) to water in stream channels, additionally notify the National Response Center (24-hour verbal notification) and EPA Region 6.

5.7.1 ADDITIONAL REPORTING REQUIREMENT FOR PETROLEUM STORAGE TANKS

New Mexico Environment Department (NMED) regulations from June 2009 require verbal reporting within 24 hours of release of petroleum products from regulated tanks to the Petroleum Storage Tank (PST) Bureau when there is:

- evidence of release of regulated substances;
- unusual operational conditions (that would cause concern about a release); or
- monitoring results that show loss from the system.

Regulated tanks include those of 1320 gallons to 55,000 gallons and exclude all sizes of tanks used to fuel emergency generators.

This reporting requirement is in addition to the reporting under NMWQCC Regulations and CWA requirements for such releases. Call the PST Bureau at 476-4397 during business hours and 827-9329 after closing.

If there is more than one activity team member, the PIC conducts a readiness check during the tailgate briefing to note any local work conditions that could affect the work and reminds the team of the documented hazards and controls. At this time workers also verify that each other's PPE is adequate.

Title: Environmental Reporting Requirements for Releases or Events	ENV-DO-QP-101.2	Page 10 of 24
	Effective Date: June 12, 2012	

If a release (see Definitions) is reportable under NMWQCC Regulations, continue through the next sections to determine if the release/event is reportable under other rules and proceed to the Section, *Reporting a Release or Event*.

5.7.2 ADDITIONAL REPORTING REQUIREMENTS UNDER NPDES PESTICIDE GENERAL PERMIT

Adverse incidents, an unusual or unexpected incident that an Operator has observed upon inspection or of which the Operator otherwise becomes aware, requires reporting under the NPDES Pesticide General Permit (PGP).

The Operator should report any adverse incidents in which:

- (1) There is evidence that a person or non-target organism has likely been exposed to a pesticide residue, and
- (2) The person or non-target organism suffered a toxic or adverse effect. The phrase toxic or adverse effect includes effects that occur within Waters of the United States on non-target plants, fish, or wildlife that are unusual or unexpected (e.g. effects are to organisms not otherwise described on the pesticide product label or otherwise not expected to be present) as a result of exposure to a pesticide residue, and may include:
 - Distressed or dead juvenile and small fishes;
 - Washed up or floating fish;
 - Fish swimming abnormally or erratically;
 - Fish lying lethargically at water surface or in shallow water;
 - Fish that are listless or nonresponsive to disturbance;
 - Stunting, wilting, or desiccation of non-target submerged or emergent aquatic plants; and/or
 - Other dead or visibly distressed non-target aquatic organisms (amphibians, turtles, invertebrates, etc.)

The phrase toxic or adverse effects also includes any adverse effects to humans (e.g. skin rashes) or domesticated animals that occur either from direct contact with or as a secondary effect from a discharge (e.g. sickness from consumption of plants or animals containing pesticides) to Waters of the United States that are temporally and spatially related to exposure to a pesticide residue.

If an Operator observes or otherwise becomes aware of an adverse incident due to pesticide application, the Operator must immediately notify the appropriate EPA Incident Reporting contact within 24 hours of the incident of the Operator becoming aware of the adverse incident. EPA Incident Reporting Contacts are listed at www.epa.gov/npdes/pesticides. These reporting requirements are in addition to any required under Federal Insecticide, Fungicide, and Rodenticide Act (FIFRA).

5.8 DETERMINING IF A RELEASE IS REPORTABLE UNDER CERCLA OR EPCRA

Under CERCLA or EPCRA, a Reportable Quantity is the action level that may trigger an appropriate response to a release under the provisions of these regulations. RQs are summarized in 40 CFR Part 302. An RQ is based on the quantity of chemical released within any 24-hour period. The RQs for extremely hazardous substances can be found in 40 CFR Part 355, Appendices A and B, in the column labeled "RQ". This table has two columns of RQs: the Statutory RQ and the Final RQ. Use the weight in the Final RQ column for determining if the release must be reported. The chemicals that have not been assigned RQs by EPA have been given statutory RQs of one pound by Congress.

Releases (see definitions) that occur within a closed space with no emissions to the ambient environment (see definitions) are exempt from this requirement.

The exceedance of an RQ requires immediate notification.

NOTE: Response procedures for "Continuous Releases" are not covered in this procedure.

5.8.1 REGULATORY CLASSIFICATION OF THE RELEASED MATERIAL

Determine the regulatory classification of the substance released with respect to the hazard classifications: Extremely Hazardous Substance (EHS) and/or Hazardous Substance (HS) (see definitions).

Often during the course of an emergency, complete information will not be available regarding type and amount of material released. In this case, best professional judgment must be used to establish the level of confidence associated with the estimates. If the uncertainty is high enough that future estimates may require reporting, it is best to err on the side of caution and follow the reporting requirements in the section *Reporting a Release or Event*.

- Identify the constituents in the material released using the Material Safety Data Sheet (MSDS), laboratory analysis, data sheet, manifest, or manufacturer information.
- A summary of the RQs can be found in 40 CFR Part 302 and 40 CFR Part 355, Appendices A and B. The RQ may also be determined using the on-line RQ Calculator (<http://homer.ornl.gov/rq/>)
- Calculate the amount of the listed chemical involved in the release (the weight of the material released multiplied by the percentage of the concentration of the listed chemical present in the material).

After determining the RQ of a released material, the ENV-DO on-call representative or SME will perform the following steps to determine if an RQ has been released.

Step	Action						
1	Obtain an estimate of the quantity and type of material released (e.g. 4 pounds of chlorine gas or 150 curies of tritium).						
2	Compare this quantity against the RQs provided in Appendix B to 40 CFR 302 and 40 CFR 355, Appendices A and B.						
3	<p>If this is an airborne release of radioactive materials, it is reportable if the RQ is exceeded AND if the release could cause an annual exposure to the nearest downwind residence or business of 10 mrem (40 CFR 61, Subpart H).¹ The exposure estimate should be made by an environmental health physicist.</p> <table border="0"> <tr> <td>If the release...</td> <td>Then...</td> </tr> <tr> <td>Is over the RQ AND could cause the Laboratory to exceed the 10 mrem/yr standard to downwind businesses or residences</td> <td>Proceed to section <i>Reporting a Release or Event</i>.</td> </tr> <tr> <td>Is less than the RQ AND could NOT cause the Laboratory to exceed the 10 mrem/yr standard.</td> <td>No reporting is required under CERCLA or EPCRA. Proceed to Step 4.</td> </tr> </table>	If the release...	Then...	Is over the RQ AND could cause the Laboratory to exceed the 10 mrem/yr standard to downwind businesses or residences	Proceed to section <i>Reporting a Release or Event</i> .	Is less than the RQ AND could NOT cause the Laboratory to exceed the 10 mrem/yr standard.	No reporting is required under CERCLA or EPCRA. Proceed to Step 4.
If the release...	Then...						
Is over the RQ AND could cause the Laboratory to exceed the 10 mrem/yr standard to downwind businesses or residences	Proceed to section <i>Reporting a Release or Event</i> .						
Is less than the RQ AND could NOT cause the Laboratory to exceed the 10 mrem/yr standard.	No reporting is required under CERCLA or EPCRA. Proceed to Step 4.						
4	<p>If this is a release of non-rad material, it is reportable if the RQ is exceeded.</p> <table border="0"> <tr> <td>If the amount released is..,</td> <td>Then...</td> </tr> <tr> <td>Equal to or greater than the RQ</td> <td>Proceed to Section <i>Reporting a Release or Event</i>.</td> </tr> <tr> <td>Less than the RQ</td> <td>Proceed to Step 3</td> </tr> </table>	If the amount released is..,	Then...	Equal to or greater than the RQ	Proceed to Section <i>Reporting a Release or Event</i> .	Less than the RQ	Proceed to Step 3
If the amount released is..,	Then...						
Equal to or greater than the RQ	Proceed to Section <i>Reporting a Release or Event</i> .						
Less than the RQ	Proceed to Step 3						
5	Continue to re-evaluate the release as new data becomes available. Perform Steps 1 through 3 as necessary.						

¹ It should be noted that "Area sources and other sources that are subject to regulations that limits their total annual emissions should generally report their releases at or above the RQ of hazardous substances (HSs) and extremely hazardous substances (EHSs) that are caused by accidents, malfunctions, unanticipated releases and other releases that are not part of the facility's normal operations." Federal Register, Volume 67, No. 47, Notices FRL-7172-4, Guidance on the CERCLA Section 101(10)H, "Federally Permitted Release Definition for Certain Air Emissions".

5.9 DETERMINING IF A RELEASE IS REPORTABLE UNDER BIOLOGICAL OR CULTURAL REQUIREMENTS

There are a number of laws and regulations related to protection of biological and cultural resources which are applicable to the Laboratory. These laws and regulations include:

- National Environmental Policy Act
- Endangered Species Act
- Bald Eagle Protection Act
- Migratory Bird Treaty Act
- New Mexico Wildlife Conservation Act
- New Mexico Endangered Species Act
- National Historic Preservation Act
- Native American Graves Protection and Repatriation Act
- Archaeological Resources Protection Act

Reporting of impacts to biological resources under the preceding laws and associated regulations is not specifically defined. This is also the case for reporting of most cultural resources impacts under the National Historic Preservation Act. The use of professional judgment by the ENV-DO on-call representative and SME is required.

Reporting of impacts under the Native American Graves Protection and Repatriation Act is specifically governed by the following document "A Standard Operating Procedure for the Inadvertent Discovery of Native American Human Remains and Associated Funerary Objects, Sacred Objects, or Objects of Cultural Patrimony at Los Alamos National Laboratory" (LA-UR-06-6712) prepared for the Department of Energy Los Alamos Site Office (DOE LASO) by the LANL Cultural Resources Team and implemented on January 30, 2008.

Reporting of impacts under the Archaeological Resources Protection Act (ARPA) is governed in part by the Act and also by LANL Cultural Resources Team Procedure ES-415, *Archaeological Resources Protection Act*.

5.9.1 REPORTS TO DOE LASO

In general, any release or event that poses a significant impact to biological or cultural resources requires reporting to DOE LASO as soon as possible and may require reporting to LANL management and DOE HQ through the ORPS. Examples of significant impacts to biological resources include:

- Release of toxic substances into listed species habitat
- Damage to a wetland or listed species habitat by a landscape-altering event such as wildfire
- Other events that would likely result in death or injury of a threatened or endangered species

- Examples of significant impacts to cultural resources include:
- Unauthorized excavation of an archaeological site
- Damage to an archaeological or historic site
- Removal of archaeological or historic artifacts

The ENV on-call representative or SME for biological or cultural resources should notify DOE LASO as soon as possible so that DOE LASO can complete the required notifications to the appropriate agencies (e.g., U.S. Fish and Wildlife Service, State Historic Preservation Office) within 24 hours.

5.10 REPORTING A RELEASE OR EVENT

If a release or event is reportable (as determined by one or more of the previous sections), the Laboratory is required to meet certain reporting requirements. The emergency notification requirements in this section must be followed upon determination that a release or event is reportable.

For informational purposes, a summary of emergency release/event reporting requirements is provided in Attachment 2. This document summarizes the primary statutes and the associated reporting requirements.

Maintain a notebook to record pertinent information about the release and to document the actions taken (see section *Records Resulting from This Procedure*).

If RCRA reporting requirements are triggered, see the flow chart in Attachment 1, Emergency Notification Requirements for RCRA.

Perform the following steps immediately after establishing that reporting will be performed:

Step	Action
1	<ul style="list-style-type: none"> • Number of persons injured and the nature of injuries (e.g., life-threatening or minor injury) • Extent of any protective actions taken (e.g., evacuations) • Name, address, and telephone number of the person to contact for further information • Whether the substance is an HS or EHS (see definitions) • Associated health risks and medical attention necessary for exposed individuals • If available, information concerning the release of any hazardous and/or mixed waste which may endanger public or private drinking water supplies • Assessment of actual or potential hazards to human health or the environment outside the facility • If available, estimated quantity and disposition of recovered material that resulted from the incident • Precautions to take due to the release/event, including, in the case of fire, those associated with special hazards due to hazardous and/or mixed waste • Any other information which may help emergency personnel responding to the incident.
2	<p><i>[For RCRA: skip this step; see flow chart (Attachment 1).]</i></p> <p>For releases of substances that are classified as CERCLA hazardous substances, contact the National Response Center at 800-424-8802.</p> <p>Note: If it is an EHS but not a CERCLA hazardous substance, reporting is only necessary to state and local authorities.</p> <p>Exception: For reportable water releases, the NRC needs to be notified ONLY if the release includes oil (such as a sheen on the water surface).</p>

Step	Action
3	<p><i>[For RCRA: skip this step; see flow chart (Attachment 1).]</i></p> <p>If the release is outside the LANL boundaries, or has the potential to go outside, additionally contact the New Mexico State Police at 505-827-9126 (State Emergency Response Commission—SERC).</p> <p>Contact the Los Alamos County Police at (505) 662-8222 (Local Emergency Planning Committee—LEPC).</p> <p>Contact the New Mexico Environment Department:</p> <ul style="list-style-type: none"> • During work hours: 505-476-6000 • 24-hr Emergency Hotline: 505-827-9329 <p>DOE O 231.1A Requires notification and reporting through the Facility Operations Director to DOE LASO and DOE HQ given a set of reporting criteria where the timelines from time of event and categorization given the circumstances of the event to verbal and/or written notification is 2-hours. For certain types of environmental events, the reporting criteria are more stringent than what is required in Federal and State laws and requirements (e.g. 50 percent of an RQ is ORPS reportable within the ORPS system). For all environmental events, the ENV On Call individual and/or ENV SME must ensure that the appropriate FOD or designee has been engaged as per P322-3, Performance Improvement from Abnormal Events, and this will ensure that ORPS notification and reporting criteria are being met.</p>
4	If requested by any of the above organizations, provide updates as new information becomes available.

Any release to the environment that has been determined to be reportable by the ENV on-call representative or SME shall be reported through the LANL management chain in accordance with [PD1200, Emergency Management](#) and [P322-3, Performance Improvement from Abnormal Events](#). LANL management shall be notified immediately that a release notification to state or federal regulatory agencies is required so that DOE notification and reporting requirements are met. LANL management approval is not required prior to environmental reports and notifications made to the regulatory agencies in order to assure that the deadline for reporting is not exceeded.

5.10.1 STEPS TO NOTIFY LANL MANAGEMENT

To notify LANL management and to complete the environmental reporting process to DOE, state and federal agencies, and Pueblo Environmental Departments, perform the following steps:

Who	Step	Action
ENV-DO on-call representative or SME	1	<p>Determine that a release to the environment is reportable to state, federal, or Pueblo entities and required under regulations.</p> <p>NOTE: ORPS reporting is a FOD and RAD responsibility and will seek advisement from ENV SMEs.</p>
	2	<p>Contact the following individuals by phone.</p> <ul style="list-style-type: none"> • Team Leader/Direct Supervisor • Group Leader/Deputy Group Leader • ENV-DO Division Leader or Designee for Reporting <p>If no direct contact can be made, leave messages by pages or phone.</p>
ENV-DO Division Leader or Designee for Reporting	3	<p>Notify the ADES&H Directorate Office and assure that the notification process continues through the LANL management chain to the PADOPs Office as specified in PD 1200-1 Emergency Management, and <u>P322-3, Performance Improvement from Abnormal Events</u>.</p>
	4	<p>Notify the ADEP Directorate Office if the release originated or impacted a Solid Waste Management Unit (SWMU) or Potential Release Site (PRS).</p>
		<p>As per <u>PD1200</u>, verbal and written notifications must be made up the management chain by use of the PADOPS report. Generally, this is the responsibility of the FOD or the FOD designee. However, ENV on-call personnel may be required to perform this function from time to time. Therefore, on-call personnel must understand who will perform this reporting function.</p>
ENV-DO on-call representative or SME	5	<p>Notify the DOE LASO program contact for the release.</p>
	6	<p>Complete the environmental reporting to state and federal agencies prior to the regulatory deadline for reporting.</p>
	7	<p>Notify Pueblo Environmental Departments of the release when potentially impacted.</p>
SME	8	<p>Complete 14-day and other follow-up reports to the state and federal agencies.</p>

Title: Environmental Reporting Requirements for Releases or Events	ENV-DO-QP-101.2	Page 18 of 24
Effective Date: June 12, 2012		

If the release involved radioactive materials, the ENV on-call representative or SME will notify ENV-ES. ENV-ES will additionally notify:

EPA Region 6

(214) 665-8541

If there is a release of contaminants to a wetland or destruction of a wetland, OR if the event could result in the "take" of a threatened or endangered species (i.e., a wildfire), the ENV on-call representative or SME will notify DOE LASO Environmental Office as soon as possible. DOE LASO is required to notify U.S. Fish and Wildlife Service within 24 hours.

After all the above notifications have been made, or when requested, the ENV on-call representative or SME will hand off responsibility for additional actions and follow-up to the affected environmental group. (Which group is responsible will depend on the type and location of the release and the governing regulations or statutes.) Provide all relevant records. See Section: Records Resulting from this Procedure.

In order to communicate events at LANL which may impact the public and or the environment, ENV staff will notify the New Mexico Environment Department of events that may not require formal regulatory notification. Examples of such events in the past have been small wild land fires.

6.0 REFERENCES

The following documents are referenced in this procedure: 40 CFR 302, *Designation, Reportable Quantities, and Notification*

- 40 CFR 261, 264 Subpart D 270.30
- DOE guidance document *PCB Spill Response and Notification Requirements* (EH-231-059/1294), available on the ENV-RCRA web page
- DOE – Office of Environmental Guidance, *CERCLA Information Brief*, EH-231-001-0490 (April 1990)
- EPA Web Site: <http://www.epa.gov/>
- EPCRA Information Web Site: <http://www.chemicalspill.org/EPCRA-facilities/spill.html>
- Federal Register, Volume 67, No. 47, Notices FRL-7172-4, Guidance on the CERCLA Section 101(10)H, *Federally Permitted Release Definition for Certain Air Emissions*
- [PD1200, Emergency Management](#)
- [P322-3, Performance Improvement from Abnormal Events](#)
- LANL RCRA Permit No. NM0890010515-1
- LANL NPDES Permit No. NM00283 National Response Center (NRC) Web Site: <http://www.nrc.uscg.mil/>
- NMWQCC Regulations, 20.6.2 NMAC, dated December 1, 2001
- [P407, Water Quality](#)

Title: Environmental Reporting Requirements for Releases or Events	ENV-DO-QP-101.2	Page 19 of 24
Effective Date: June 12, 2012		

- [QP-5.8, Identification, Documentation, and Reporting of Newly Discovered Potential Release Sites, ADEP Procedure.](#)
- RQ Calculator Web Site: <http://homer.ornl.gov/rq/>

7.0 DEFINITIONS

ADES&H: Associate Directorate for Environment, Safety, and Health

ADEP: Associate Directorate for Environmental Programs

CAA: Clean Air Act

CERCLA: Comprehensive Environmental Response, Compensation, and Liability Act

Continuous Release: A release is continuous if it “occurs without interruption or abatement or if it is routine, anticipated, intermittent, and incidental to normal operations or treatment processes.” The release must also be “stable in quantity and rate,” which means that it must be predictable and regular in the amount and rate of emission. The response procedures for continuous releases are not covered by this document. See guidance in Reporting Continuous Releases of Hazardous and Extremely Hazardous Substances under CERCLA and EPCRA. [DOE/EH-0441, guidance document, 372,099 bytes, 51 pp.], available at: <http://homer.ornl.gov/sesa/environment/guidance/cercla/CONTIN.PDF>.

CWA: Clean Water Act

ENV-DO: Environmental Protection Division

Environment: includes "water, air, land, and the interrelationship which exists among and between water, air, land, and all living things." (40 CFR 355.20)

EPCRA: Emergency Planning and Community Right-to-Know Act

ER-DO: Emergency Response Division

Extremely Hazardous Substance (EHS): EPCRA establishes emergency reporting requirements for extremely hazardous substances in 40 CFR 355, Appendix A. All of these substances are also CWA and CERCLA “hazardous” substances

FOD: Facility Operations Director

Hazardous Substance (HS): These substances are summarized in 40 CFR Part 302. As used in this context, refers to: (1) any elements, compounds, mixtures, solutions, or substances specially designated by EPA under Section 311 of the Clean Water Act (CWA) (40 CFR 116.4); (2) any toxic pollutants listed under Section 307(a) of the CWA; (3) any hazardous substances regulated under Section 311 (b)(2)(A) of the CWA; (4) any listed or characteristic RCRA hazardous waste (40 CFR 261), (5) any hazardous air pollutants listed under Section 112 of the Clean Air Act (CAA); or (6) any imminently hazardous chemical substances or mixtures regulated under Section 7 of the Toxic Substances Control Act (TSCA)

LEPC: Local Emergency Planning Committee. Locally, the contact is through Los Alamos County Police and Fire Departments

NMWQA: New Mexico Water Quality Act

Title: Environmental Reporting Requirements for Releases or Events	ENV-DO-QP-101.2	Page 20 of 24
	Effective Date: June 12, 2012	

NMWQCC: New Mexico Water Quality Control Commission

NPDES: National Pollutant Discharge Elimination System

NRC: National Response Center

OSC: On-Scene Commander

PADOPS: Principal Associate Director for Operations

PCBs: Polychlorinated Biphenyls

PST: Petroleum Storage Tank

RCRA: Resource Conservation and Recovery Act

Release: Any unpermitted spilling, leaking, pumping, pouring, emitting, emptying, discharging, injecting, escaping, leaching, dumping, or disposing of contaminants into the environment, excluding: (1) emissions from the engine exhaust of any vehicle, (2) certain releases of source, byproduct, or special nuclear material from a nuclear incident, or (3) normal application of fertilizer

RQ: Reportable quantity

SARA: Superfund Amendments and Reauthorization Act

SERC: State Emergency Response Commission. In NM, the contact is through the NM Department of Public Safety.

SME: Subject Matter Expert.

TSCA: Toxic Substances Control Act

8.0 ATTACHMENTS

Attachment 1: Emergency Notification Requirements for RCRA

Attachment 2: Summary of Emergency Release or Event Reporting Requirements

By requesting credit for this required reading I acknowledge that I have read and understand the contents of this document and I will follow and meet the requirements in this document unless it is unsafe to do so.

Click to
Acknowledge

ATTACHMENT 1: EMERGENCY NOTIFICATION REQUIREMENTS FOR RCRA

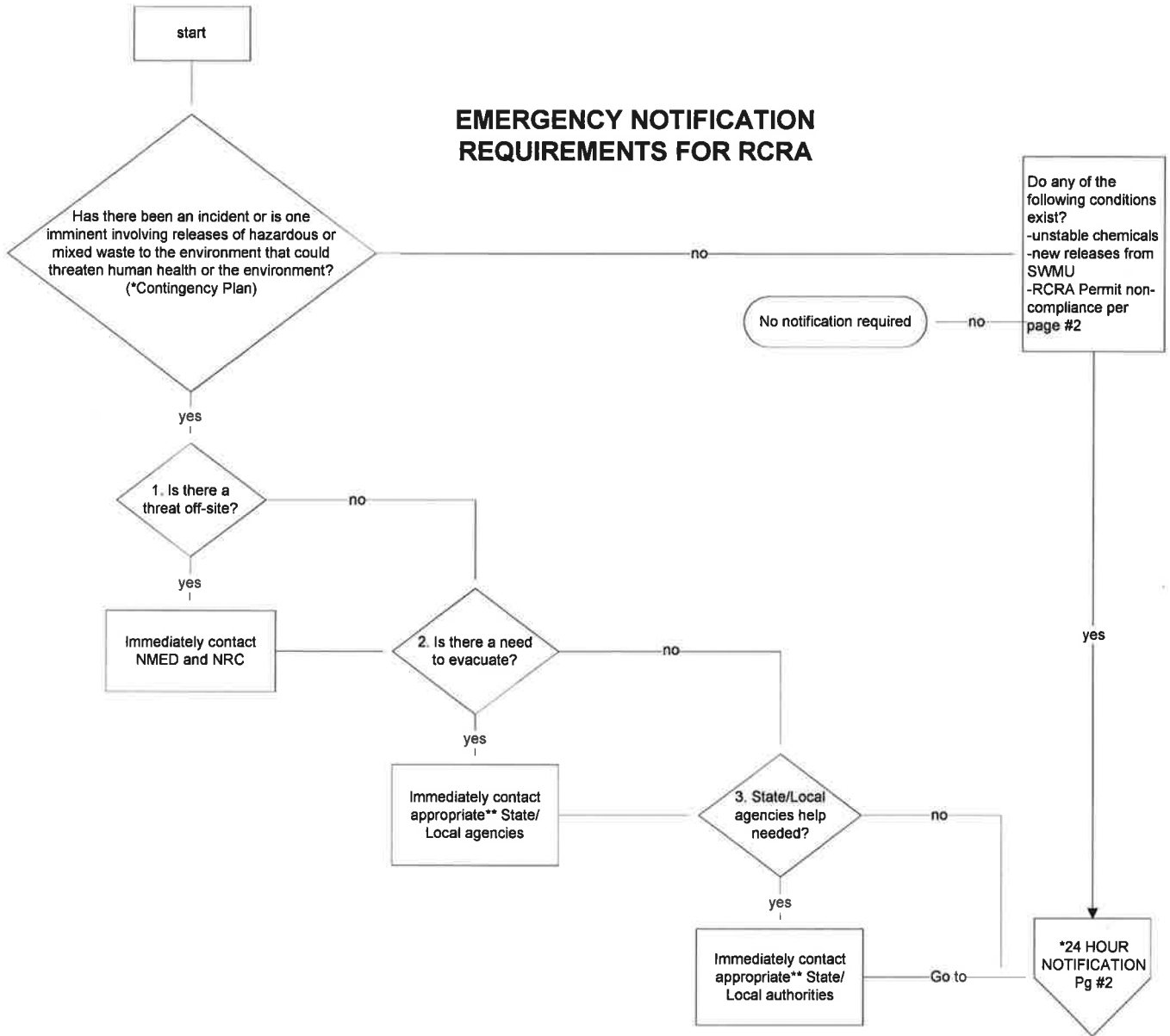

24 HOUR NOTIFICATION

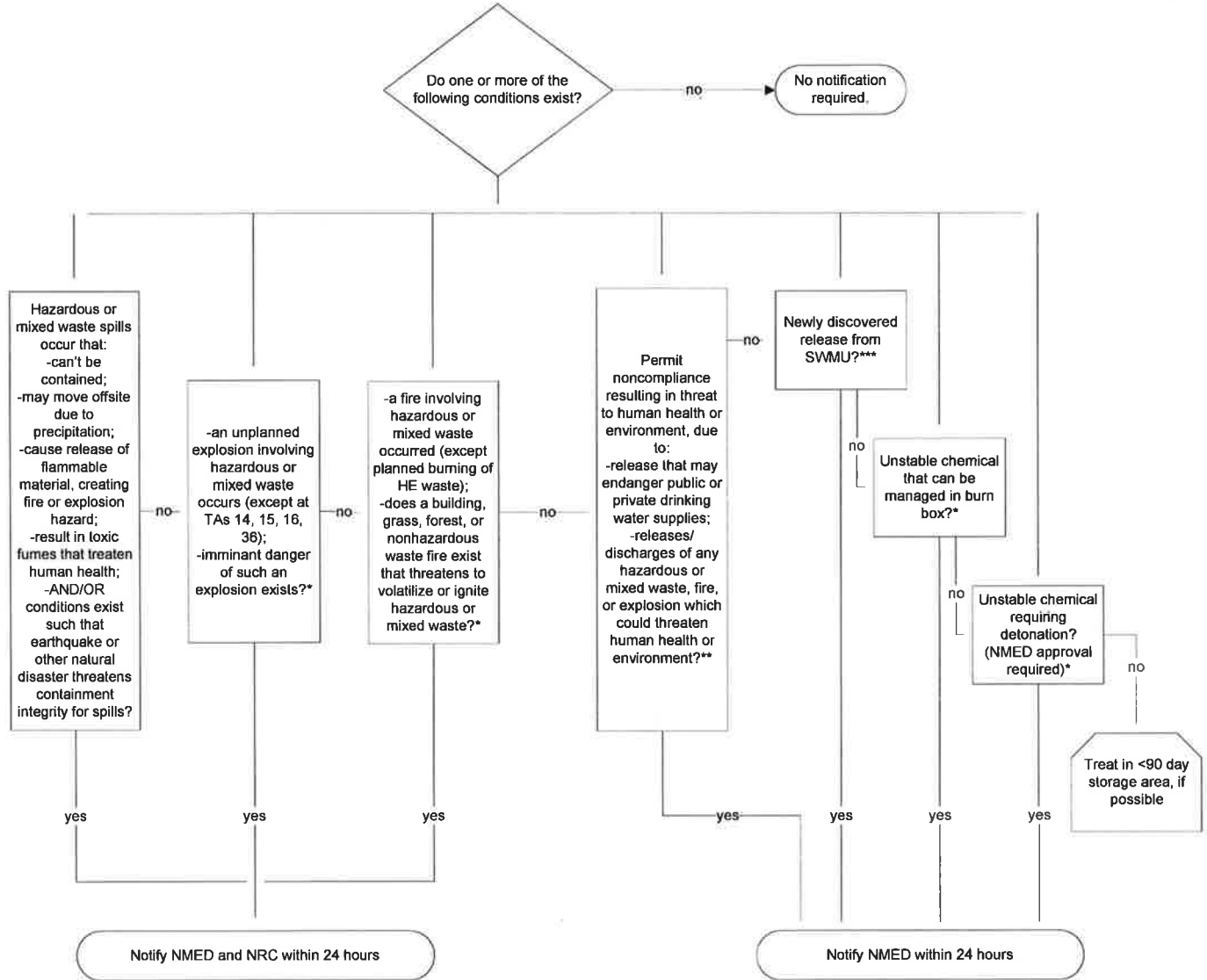

*Contingency Plan implementation, need for burn box use, or for detonation to be determined by EM&R

**To be determined by ENV-RCRA

***To be determined by WES-WA and ENV-RCRA

ATTACHMENT 2: SUMMARY OF EMERGENCY RELEASE OR EVENT REPORTING REQUIREMENTS

NOTE: This is only a guide and does not cover all federal, state, or permit reporting requirements. Refer to the Code of Federal Regulations and the RCRA Permit for more details regarding these regulations.

STATUTE	REGULATIONS	INCIDENT	REPORT TO/BY	REPORTING
Clean Water Act(CWA)	40 CFR 110.6	Oil discharge (film/sheen/discoloration) to water surface or shoreline, or violation of water quality standards.	NRC. If not practical then EPA by person in charge of facility.	Immediately, no later than 24 hours. Follow-up not required.
Clean Water Act (CWA)	40 CFR 117.21	Discharge of hazardous substance (equal to or above RQ)	Appropriate govt. agencies by person in charge of facility.	Immediately Follow-up not required.
Clean Water Act (CWA)	40 CFR 122.28	Adverse incident which includes evidence that a person or non-target organism has been exposed to a pesticide residue or the person or non-target organism suffered a toxic or adverse effect.	Report to EPA within 24 hrs.	30 Day Adverse Incident Written Report for PGP required.
New Mexico Water Quality Control Commission Regulations (NMWQCC Regulations)	20.6.2.1203 NMAC	Discharge from any facility of oil or other water contaminant, in such quantity as may with reasonable probability injure or be detrimental to human health, animal or plant life, or property, or unreasonably interfere with the public welfare or use of the property.	New Mexico Environment Department by ENV-RCRA. Copy to EPA.	As soon as possible after learning of such a discharge, but in no event more than 24 hours thereafter (verbal notification). 7 day written report (Calendar Days) 15 day written Corrective Action Plan.
Comprehensive Environmental, Response, Compensation, and Liability Act (CERCLA)	40 CFR 302.6(a)	Hazardous substance release (Equal to or greater than RQ).	Report to NRC by ENV or WES SME	Within fifteen minutes Follow-up not required
Emergency Planning and Community Right- to-Know Act (EPCRA)	40 CFR 355.40	Release of SARA extremely hazardous substance or CERCLA hazardous substance equal to or greater than RQ.	LEPC, SERC, or local emergency response personnel (911 in case of transportation related release) by owner/operator.	Within fifteen minutes Follow-up required within seven calendar days.

STATUTE	REGULATIONS	INCIDENT	REPORT TO/BY	REPORTING
Resource Conservation and Recovery Act (RCRA)	40 CFR 262.34, 263.30, 264.51, 264.56 & .196, 265.51, .56 & .196, 270.14, & .30, 273.17, .37 & .54, 279.43 & .53, 280.50, .52, .53, .60,	Release, fire, or facility explosion that threatens human health or environment.	NRC/OS C/state/ local /EPA Regional Administrator by ENV-DO or ENV-RCRA SME.	Immediate and/or within 24 hours (see flow chart) Follow-up: varies from 5 to 30 days report to OSC/NRC/EPA Regional Administrator.
Toxic Substance Control Act (TSCA)	40 CFR 761.120, 761.125	PCB spill (equal to or greater than 50 ppm) with release to surface water/drinking water supplies/sewers/ grazing lands, etc. OR PCB spill over 10 pounds	NRC and EPA Region 6 Office of Pesticides and Toxic Substances by person in charge.	Within 24 hours Follow-up: as required by agency.
Operational events to include environmental releases and reporting	DOE Order 231.1A	As per criteria within DOE Order 231.1A. Examples include 50 percent of an RQ	DOE LASO and DOE HQ by FOD through ESH-OFF	Verbal notifications in 2 hours after categorization and written notifications within from 2 hours to NLT 2 business days depending on the severity and DOE criteria
N/A	N/A	Incidents which may be of concern to the public, such as wild land fires, activities which may have a visual impact that concerns the public, etc.	NMED	As soon as possible

ENV-CP-QP-045.1



Effective Date: September 5,
2013

Next Review Date: August 5,
2015

Environment, Safety, Health Directorate

**Environmental Protection – Compliance Programs
Quality Procedure**

**Installing, Setting Up, and Operating ISCO Samplers
for the MSGP**

Reviewers:

Name: Melanie Lamb	Organization: ADESH-OIO, QA Specialist	Signature: Signature on file	Date: 8/28/13
-----------------------	----------------------------------------------	---------------------------------	------------------

Derivative Classifier: **Unclassified** **DUSA ENVPRO**

Name: Ellena Martinez	Organization: ADESH-OIO	Signature: Signature on file	Date: 8/28/13
--------------------------	----------------------------	---------------------------------	------------------

Approval Signatures:

Subject Matter Expert: Holly Wheeler	Organization: ENV-CP	Signature: Signature on file	Date: 8/29/13
Responsible Line Manager: Michael Saladen	Organization: ENV-CP Team Lead	Signature: Signature on file	Date: 8/29/13
Responsible Line Manager: Anthony Grieggs	Organization: ENV-CP Group Leader	Signature: Signature on file	Date: 9/5/13

CONTROLLED DOCUMENT

This copy is uncontrolled. The controlled copy can be found on the ENV Division Web page.

Users are responsible for ensuring they work to the latest approved version.

History of Revisions

Document Number <i>[Include revision number, beginning with Revision 0]</i>	Effective Date <i>[Document Control Coordinator inserts effective date]</i>	Description of Changes <i>[List specific changes made since the previous revision]</i>
0	03/11	New Document.
1	04/13	Biennial Review and Revision
2	09/13	Biennial Review and Revision

Table of Contents

1.0 PURPOSE 4

2.0 SCOPE 4

 2.1 Hazard review 4

3.0 RESPONSIBILITIES 4

 3.1 Prerequisites 4

4.0 DOCUMENT CONTROL/RECORDS MANAGEMENT 4

5.0 WORK PROCESSES 5

 5.1 Equipment and Tools 5

 5.2 ISCO Sampler Installation 6

 5.3 Configuring ISCO 3700 Samplers 7

 5.4 Programming ISCO 3700 Samplers..... 7

 5.5 Activating ISCO 3700 Samplers 8

 5.6 Configuring ISCO Avalanche Samplers 9

 5.7 Programming ISCO Avalanche Samplers..... 10

 5.8 Activating ISCO Avalanche Samplers..... 10

 5.9 Standing Down or Winterizing Samplers 11

 5.10 Sampler Reset and Re-initialization After Sample Collection..... 12

 5.11 Removing a Sampler 12

6.0 REFERENCES 12

7.0 DEFINITIONS 13

8.0 ATTACHMENTS 13

 Attachment 1- LANL MSGP ISCO Sampler Installation Form 045-1 14

 Attachment 2- Wiring Diagram for Avalanche Sampler 15

 Attachment 3 – Battery Photovoltaic Connection Wiring 16

 Attachment 4 - ISCO 3700 Configuration Settings 18

 Attachment 5 – ISCO 3700 Program Sequence 19

 Attachment 6 – LANL MSGP ISCO Sampler Activation Form 045-3 22

 Attachment 7 – ISCO Avalanche Configuration Settings..... 23

 Attachment 8 – ISCO Avalanche Program Sequence..... 24

 Attachment 9 – LANL MSGP ISCO Sampler Winter Shut-Down Form 045-5 25

 Attachment 10 – LANL MSGP ISCO Sampler Decommission Form 045-6..... 26

Installing, Setting Up, and Operating ISCO Samplers for the MSGP	No. ENV-CP-QP-045.1	Page 4 of 26
	Effective Date: September 5, 2013	

1.0 PURPOSE

This procedure describes the installation, setup, programming, and operation of Teledyne ISCO Avalanche and Model 3700 full-size portable automated samplers used to collect storm water runoff samples for the Multi-Sector General Permit (MSGP).

2.0 SCOPE

This procedure applies to all ENV-CP technical staff and contractor personnel conducting installation, operation, maintenance and sampling activities at single stage stations used for monitoring under the MSGP.

2.1 HAZARD REVIEW

Hazards in the work described in this procedure are controlled thorough site specific IWDs. The hazard level of the activities in this procedure is moderate.

3.0 RESPONSIBILITIES

The following personnel require training before implementing this procedure:

- This procedure applies to all ENV-CP MSGP storm water compliance personnel conducting installation, operation, maintenance and sampling activities at MSGP single stage monitoring stations.

The training method for this procedure is “self-study” (reading). For ENV-CP staff, this is documented in accordance with ENV-DO-QP-115, *Personnel Training*. Other participating groups may require training documentation pursuant to local procedures.

Actions specified within this procedure, unless proceeded with “should” or “may,” are to be considered mandatory (i.e., “shall”, “will”, “must”).

3.1 PREREQUISITES

Personnel performing this procedure will be familiar with the most current versions of the following procedures and operation manuals:

- ENV-CP MSGP Sampling and Analysis Plan for the current monitoring year
- Manual for Teledyne ISCO Sampler Model 3700.
- Manual for Teledyne ISCO Avalanche refrigerated sampler
- Facility/FOD specific IWDs for the MSGP

4.0 DOCUMENT CONTROL/RECORDS MANAGEMENT

The following records are generated as a result of this procedure and are maintained in accordance with ENV-DO-QP-110, *Records Management Program* with the originals on file at ENV-CP offices:

Completed work orders for:

- LANL MSGP ISCO Sampler Installation Form 045-1(Attachment 1)
- LANL MSGP ISCO Sampler Activation Form 045-3 (Attachment 6)
- LANL MSGP ISCO Sampler Winter Shutdown 045-5 (Attachment 9)
- LANL MSGP ISCO Sampler Decommission 045-6 (Attachment 10)

5.0 WORK PROCESSES

The discharge of storm water from industrial facilities at Los Alamos National Laboratory (LANL, the Laboratory) is regulated under the National Pollutant Discharge Elimination System (NPDES) *Multi-Sector General Permit for Storm Water Discharges Associated with Industrial Activity* (MSGP). The current MSGP became effective on September 29, 2008 pursuant to 73 FR 56572. The Laboratory's MSGP permit coverage (Permit Tracking No. NMR05GB21) requires storm water quality monitoring to evaluate the overall effectiveness of control measures. ISCO samplers coupled with Model 1640 sampler actuators are used at MSGP Program monitoring stations. Refrigerated (Avalanche) and/or non-refrigerated (Model 3700) samplers may be deployed; and may be configured with multi-battery arrays, solar panels, and surge protectors.

5.1 EQUIPMENT AND TOOLS

Ensure the following equipment is available in the field vehicle:

- Copy of this procedure
- Copy of the appropriate Integrated Work Document(s) (IWDs)
- Charged spare battery(ies)
- Battery voltage tester
- Spare tubing (pump, suction, discharge types, sampler specific)
- Spare sample bottles
- Shovels
- Wooden stakes
- Plastic wire "zip" ties
- Cell phone (only government cell phones with the battery removed are allowed in secure areas)
- Appropriate tools (including insulated tools for electrical work) in tool box
- Issued Work Orders and associated forms
- Necessary access and station keys
- Ziploc® plastic storage bags
- Tape measure
- Sturdy hiking boots or steel toed shoes with soles that grip

The time on the ISCO sampler clock must be verified upon arrival at the site. The ISCO clocks must be set to Mountain Standard Time (MST) at all times, with no daylight saving time adjustment. Cellular phones can be used to verify the time.

5.2 ISCO SAMPLER INSTALLATION

Step	Action
1	Work Orders are issued for all field operations at individual MSGP monitored outfalls. Obtain the Work Order with the LANL MSGP ISCO Sampler Installation Form 045-1 (Attachment 1). The Work Order specifies the MSGP outfall and target date for the work to be performed. An outfall-specific equipment list with specifications and configuration settings is provided on each Work Order.
2	Deploy the ISCO sampler and charged battery on level ground above the flood plain. Often, large tool/storage boxes (Greenlee™) are used for equipment protection in the field. NOTE: These boxes are locked. Therefore, a key should be obtained prior to accessing them. The sampler should be as level as possible to allow effective sample collection. Verify/record the ISCO sampler serial number and the battery tracking number(s) on the Work Order.
3	Install the separate protective battery box for the charged battery (follow manufacturer's instructions).
4	Determine the bottle set configuration from the equipment list on the Work Order. <ul style="list-style-type: none"> • If a Model 3700 sampler is indicated, install the correct distributor arm (has either "12" or "24" embossed on bottom at outlet). • For an Avalanche sampler, attach either the discharge tube guide (single bottle configuration) or the distributor arm (multi-bottle configuration) and the appropriate bottle adapter plate. If an adapter plate is not available, the inside of the sampler may need to be configured by hand (i.e., add form) to prevent bottles from moving around during a sampling event. • Install required bottles and retaining devices in the sampler base. • Check that the end of the discharge tubing does not extend below the bottom face of the distributor arm (where it could snag the bottle tops and jam as the arm advances through the bottle sequence). • Remove and place the clean bottle caps in a new Ziploc® plastic bag.
5	Attach a length (in whole foot increments) of 3/8-inch diameter Teflon suction line to the sampler intake line and anchor as needed for the Outfall location. Measure and record (for later programming steps) the tubing length used. Route the sample tubing downslope from the sampler to the intake point so that there is a continuous slope with no valleys that could retain water between sample intervals.
6	Install the actuator: <ul style="list-style-type: none"> • Anchor a stake to the channel bottom in the main flow of the outfall discharge. • Attach the sampler intake tube and the 1640 liquid level detector (actuator) to the stake. • Position the actuator at least ½ inch above the intake tube to ensure there is enough water to submerge the intake when the sampler is activated. • Connect the actuator to the sampler using the cable connector provided by the manufacturer. • If necessary, use a gravel bag to create a small pooling area for the actuator and sampler intake to sit in. <p>The actuator height above the channel bottom is established using professional judgment. For example, the intake may be positioned 1 inch or less above the bottom of low-flowing wide channels, but higher than 1 inch in a high-flowing narrow channel.</p>

7	<p>NOTE: You must be a trained electrical worker and have completed all required courses in Training Plan #2876 to conduct this step.</p> <p>Connect the sampler to the power source, either a 12 Volt 110 A-h deep cycle lead acid battery or other power source such as a multi-battery array coupled with a solar panel, as appropriate. Record the battery tracking numbers in the equipment list section of the Work Order. (Refer to Attachments 2 and 3 for the wiring diagram for Avalanche sampler installation.)</p>
---	---------------------------------------------------------------------------------------------------------------------------------------------------------------------------------------------------------------------------------------------------------------------------------------------------------------------------------------------------------------------------------------------------------------------------------------------------------------------------------------------------------------------------------------

5.3 CONFIGURING ISCO 3700 SAMPLERS

Step	Action
1	When a new ISCO 3700 sampler is being installed, configure the sampler in accordance with the steps contained in this section. Follow the project-specific configuration settings as indicated on the Work Order and given in Attachment 4, ISCO 3700 Configuration Settings.
2	Turn on the sampler by pressing the “On” button.
3	Press the “Enter/Program” button.
4	Select “Configuration”.
5	Set the configuration parameters in accordance with the guidance in Attachment 4, ISCO 3700 Configuration Settings. After each selection is made, press the “Enter” button to allow the next configuration parameter to be displayed on the screen.
6	<p>After the programming is complete, select “Run diagnostics” and press “Enter” to run the system diagnostic test. The diagnostic tests include the following:</p> <ul style="list-style-type: none"> • RAM and ROM test • LCD test • Pump test (“OFF/ON” number should be between 50 and 200 for a successful test) • Distributor test -- select “YES” to run test. Test will move the distributor to Position 24 and then return it to Position 1.
7	Following the diagnostic tests, “Reinitialize Controller” will be displayed. Select “No” and press “Enter.” <u>Do not select “Yes.”</u> If “Yes” is selected, the sampler will reset a number of configuration and program settings to the factory default values.
8	To leave the configuration sequence, use the “Exit configuration” and press “Yes” or press the “Enter/Program” key.

5.4 PROGRAMMING ISCO 3700 SAMPLERS

Step	Action
1	Follow the steps in this process to program a new ISCO or to confirm the program settings are correct for a specific location. Follow the project-specific program settings as indicated on the

	work order and given in Attachment 5, ISCO 3700 Program Sequence.
2	Turn on the sampler by pressing the “ON” button
3	Press the “Enter/Program” button.
4	Select “Program”.
5	Set the program parameters in accordance with the guidance on Attachment 5, ISCO 3700 Program Sequence. After each selection is made, press the “Enter” button to allow the next configuration parameter to be displayed on the screen.
6	Set the switch on the actuator to “Latch.”
7	NOTE: You must be a trained electrical worker and have completed all required courses in Training Plan #2876 to conduct this step.
8	Complete the responses for the sampler installation tasks listed on the Work Order. Sign and date the Work Order and ensure all items contained within it have been completed.

5.5 ACTIVATING ISCO 3700 SAMPLERS

Step	Action
1	<p>Follow the steps in this section when a Work Order is received to activate a sampler (generally at the beginning of a field season or at the beginning of the next quarter after the last quarterly monitoring sample was obtained).</p> <p>Note: The MSGP monitoring quarters are as follows</p> <ul style="list-style-type: none"> • April 1 through May 31 • June 1 through July 31 • August 1 through September 30, and • October 1, through November 30.
2	<p>Obtain the Work Order with the LANL MSGP Sampler Activation Form 045-3 (Attachment 6). The Work Order specifies the MSGP Outfall and target date for the work to be performed. An Outfall-specific equipment list with specifications and configuration settings is provided on each Work Order.</p> <p>NOTE: You must be a trained electrical worker and have completed all required courses in Training Plan #2876 to conduct this step.</p> <p>If not already installed, install and hook up the charged battery.</p> <p>If a battery is already in place, use the voltage tester to check for minimum voltage of 11.7 volts. If the voltage is lower, replace the battery with a charged battery.</p>
3	Turn the sampler ON. “Program halted” will be displayed; press the Enter/Program button to enter program/configure sequence.
4	Check the configuration and programming parameters to ensure they are still correct for the specific installation (see Attachment 4 and 5 for the correct parameters).
5	Check integrity and condition of sampler tubing, actuator, wiring, etc., to ensure sampler will properly collect a sample.

6	To test the integrity of the tubing, press “Pump forward” to turn on pump and test for suction at the tubing intake. Press “Stop” to turn off pump. If no suction is felt at the intake, check the integrity of the tubing and replace as necessary.
7	To activate the sampler, press “Start sampling” and “Enter” twice.
8	Ensure the sampler indicates “Sampler Inhibited”.
9	Complete the responses for the sampler activation tasks listed on the Work Order. Sign and date the Work Order and ensure all items contained within it have been completed.

5.6 CONFIGURING ISCO AVALANCHE SAMPLERS

Step	Action
1	When a new ISCO Avalanche sampler is being installed, configure the sampler in accordance with the steps contained in this section. Follow the project-specific configuration settings as indicated on the work order and given in Attachment 8, ISCO Avalanche Configuration Settings.
2	Turn on the sampler by pressing the “Standby” key.
3	From the main menu, select Other Functions, to access the menus and select options given in Attachment 8.
4	Set the configuration parameters in accordance with the guidance on Attachment 8, ISCO Avalanche Configuration Settings.
5	After the programming is complete, select “Run diagnostics” and press “Enter” to run the system diagnostic test. These include the following: <ul style="list-style-type: none"> • RAM and ROM test • Pump test (“ON/OFF” ratio should be between 0.80 and 1.25 for a successful test) • Distributor test -- select “YES” to run test. Test will move the distributor to Position 14 and then return it to Position 1.
6	Following the diagnostic tests, “Reinitialize Controller” will be displayed. Select “No” and press the “Enter” key. (If “Yes” is selected, the sampler will reset a number of configuration and program settings to the factory default values).
7	If a 700 series module (e.g., pH) is to be installed, consult the equipment manufacturer’s manual for installation instructions. NOTE: The pH module is only required at the Asphalt Batch Plant.
8	Complete the responses for the sampler installation tasks listed on the Work Order. Sign and date the Work Order and ensure all items contained within it have been completed.

5.7 PROGRAMMING ISCO AVALANCHE SAMPLERS

Step	Action
1	Follow the steps in this process to program a new ISCO or to confirm the program settings are correct for a specific location and bottle configuration. Follow the project-specific program settings as indicated on the work order and given in Attachment 8, ISCO Avalanche Program Sequence.
2	Turn on the sampler by pressing the “Standby” key.
3	Press the “Program” button.
4	Select the current program to review settings, or choose “Select New Program” to create a new program with different settings.
5	Select the current program to review settings, or choose “Select New Program” to create a new program with different settings.
6	At the prompt “Programming complete, run this program now?”, select “Yes” if sampler is scheduled to be active, and “No” if sampler is in stand down.
7	Set switch on actuator to “Latch.”
8	Complete the responses for the sampler installation tasks listed on the Work Order. Sign and date the Work Order and ensure all items within it have been completed.

5.8 ACTIVATING ISCO AVALANCHE SAMPLERS

Step	Action
1	Follow the steps in this section when a Work Order is received to activate a sampler (generally at the beginning of a field season or at the beginning of the next quarter after the last quarterly monitoring sample was obtained). Note: The MSGP monitoring quarters are as follows <ul style="list-style-type: none"> • April 1 through May 31 • June 1 through July 31 • August 1 through September 30, and • October 1, through November 30.
2	NOTE: You must be a trained electrical worker and have completed all required courses in Training Plan #2876 to conduct this step. If not already installed, install and hook up the charged battery(ies). If a battery is already in place, use the voltage tester to check for minimum voltage of 11.7 volts. If the voltage is lower, replace the battery with a charged battery.
3	Turn on sampler power. From the main menu, select “Program” and the “Enter” key to enter programming sequence, and “Other Functions” to enter the configuration settings.
4	Check the programming/configuration parameters to ensure they are still correct for the specific installation – follow the two preceding sections for the steps and see Attachment 7 and 8 for the correct parameters.
5	Check integrity and condition of sampling tubes, actuator, wiring, etc., to ensure sampler

	will properly collect a sample.
6	From the main menu, select “Other Functions” ► “Manual Functions” ► “Operate Pump” to perform a manual suction test. To test the integrity of the tubing, press “Pump forward” to turn on pump and test for suction at the tubing intake. Press “Stop” to turn off pump. If no suction is felt at the intake, check the integrity of the tubing and replace as necessary.
7	Reset the actuator by toggling the switch to “Reset” then back to “Latch.” To activate the sampler, ensure the correct program name is displayed on the main menu and select “Run”.
8	Ensure the sampler indicates “Program Disabled”.
9	Note: The Avalanche refrigeration system is active any time the controller is powered. This is true for all states (including OFF), except for the time between entering RUN and the completion of the first sample, and when the pump is running. To conserve power, the Avalanche assumes that during this time there is no sample liquid to cool.
10	Ensure that all items on the Work Order have been completed.

5.9 STANDING DOWN OR WINTERIZING SAMPLERS

Step	Action
1	Follow the steps in this section when a Work Order is received to turn off (“stand down”) a sampler (generally at the end of a field season, which is November 30, or to disable a sampler for a certain time period after a sample was collected). Fill out the LANL MSGP ISCO Sampler Winter Shut-Down Form in Attachment 9.
2	ISCO 3700: Turn off power. ISCO Avalanche: The Avalanche refrigeration system is active any time the controller is powered. This is true for all states (including OFF), except for the time between entering RUN and the completion of the first sample, and when the pump is running. To conserve power, the Avalanche assumes that during this time there is no sample liquid to cool. NOTE: To ensure that the refrigeration system does not activate during an intended stand down, disconnect the sampler from the power source.
3	Remove the battery and return it to the storage compound at TA-64 or other specified location identified by ENV-CP MSGP stormwater compliance personnel. Store cables inside the Greenlee™ box. If the actuator and tubing are not contained within conduit, disconnect these and place them in the box. Close sampler. Avalanche samplers must not be left in place for the winter, and are required to be returned to ENV-CP’s storage shed.
4	Ensure that all items on the Work Order have been completed.

5.10 SAMPLER RESET AND RE-INITIALIZATION AFTER SAMPLE COLLECTION

Step	Action
1	Follow ENV-CP-QP-047, <i>Inspecting Storm Water Runoff Samplers and Retrieving Samples for the MSGP</i> for collecting samples from an ISCO and installing new bottles so it is ready to collect new samples.
2	<p>After collecting samples and resetting the sampler, follow instructions on sample collection Work Order, the updated sample tracking log or confer with the MSGP Project Lead regarding whether the sampler should be disabled.</p> <p>If sampler is to be deactivated, follow the steps specific to each sampler provided in the preceding section.</p> <p>If an ISCO 3700 sampler is to be left activated, reset the actuator by toggling the switch to “Reset” then back to “Latch”, and press “Start sampling” and “Enter” twice. Ensure the sampler display indicates “Sampler Inhibited”:</p> <p>If an ISCO Avalanche sampler is to be left activated, reset the actuator by toggling the switch to “Reset” then back to “Latch.” From the main menu, verify the correct program name is displayed and select “Run.” Ensure the sampler display indicates “Program Disabled.”</p>

5.11 REMOVING A SAMPLER

Step	Action
1	Follow the steps in this process when a Work Order is received to un-install or remove a sampler. Fill out the LANL MSGP ISCO Sampler Decommission Form in Attachment 10.
2	Disconnect all equipment and remove it from the site. Return the equipment to the ENV-CP Storage Shed or other location specified by MSGP storm water compliance personnel.
3	Dispose of all equipment components that contacted samples (tubing, bottles, etc.) as waste according to applicable waste management procedure. For assistance, contact the Waste Management Coordinator for TA-59.
4	Ensure that all items on the Work Order have been completed.

6.0 REFERENCES

ENV-DO-QP-110, *Records Management Program*

ENV-DO-QP-115, *Personnel Training*

ENV-CP-QP-047, *Inspecting Storm Water Runoff Samplers and Retrieving Samples for the MSGP*

7.0 DEFINITIONS

ENV-CP: Environmental Protection Division, Compliance Programs Group

Grab Sample: A single sample collected at an NPDES outfall (using approved EPA methods) at a particular time that represents the composition of the storm water at that time and place.

IWD: Integrated Work Document

MSGP: Multi-Sector General Permit

MST: Mountain Standard Time

NPDES: National Pollutant Discharge Elimination System

8.0 ATTACHMENTS

Attachment 1- LANL MSGP ISCO Sampler Installation Form 045-1

Attachment 2- Wiring Diagram for Avalanche Sampler

Attachment 3 – Battery Photovoltaic Connection Wiring

Attachment 4 - ISCO 3700 Configuration Settings

Attachment 5 – ISCO 3700 Program Sequence

Attachment 6 – LANL MSGP ISCO Sampler Activation Form 045-3

Attachment 7 – ISCO Avalanche Configuration Settings

Attachment 8 – ISCO Avalanche Program Sequence

Attachment 9 – LANL MSGP ISCO Sampler Winter Shut-Down Form 045-5

Attachment 10 – LANL MSGP ISCO Sampler Decommission Form 045-6

By requesting credit for this required reading I acknowledge that I have read and understand the contents of this document and I will follow and meet the requirements in this document unless it is unsafe to do so.

Click to
Acknowledge

ATTACHMENT 1- LANL MSGP ISCO SAMPLER INSTALLATION FORM 045-1

ENV-QP-045.0

**LANL Multi-Sector General Permit
ISCO Sampler Installation Form**

Form 045-1 (3/2011)

Outfall: **54-G-4 : 54-PAD10E**

Project ID: **P-MSGP-2443**

Work Order ID: **MSGP-31193**

Target Date: **4/1/2013**

Project: **MSGP 2013 Sampler Install**

Reason: **MSGP 2013 Sampler Installation**

Date: _____	Time: _____
Name/Z#: _____	_____
Name/Z#: _____	_____
Load Signature: _____	_____
I confirm the information as recorded is true, accurate and complete.	

Verify the equipment list below. Make corrections as required and fill in missing information (e.g., serial numbers).

Equipment	Manufacturer	Model	Serial No.	Specification	Configuration
Actuator	ISCO	1640	210J01660		
Charge Controller	Xantrex	C-12	B20037667		
ISCO 3700 Sampler	Teledyne	3700	198H00978	Bottle Set	12- 1 1L Glass, 11 1L Poly
ISCO 3700 Sampler	Teledyne	3700	198H00978	Program	Time / Multiplex no delay
ISCO Avalanche Sampler	Teledyne	Avalanche	210J00066	Bottle Set	14 950 mL Poly
ISCO Avalanche Sampler	Teledyne	Avalanche	210J00066	Program	1-Part, 14 Bottles, 950 mL
Pb-Acid Battery	Universal	110 A-h	MSGP-110-0311-07	Voltage	> 11.7 V
Pb-Acid Battery	Universal	110 A-h	MSGP-110-0311-08	Voltage	> 11.7 V
Pb-Acid Battery	Universal	110 A-h	MSGP-110-0311-09	Voltage	> 11.7 V
Solar Panel	SunWize	SW-S85P	11004467		

ISCO Sampler Tasks

Note: If "No" provide correct information or explanation

- | | |
|-----------------------------------------------------------------------------------------------------------------------------------------------------------------------------------|----------------------------------------------------------|
| Deploy battery(ies) if not listed in equipment list above. Record serial numbers of battery(ies) installed. | <input type="checkbox"/> Yes <input type="checkbox"/> No |
| Deploy Avalanche sampler matching serial number listed in equipment list above for installation | <input type="checkbox"/> Yes <input type="checkbox"/> No |
| Deploy and install pH and Temperature Probe listed in equipment list above and probe saturation reservoir. | <input type="checkbox"/> Yes <input type="checkbox"/> No |
| Refer to the wiring diagram in ENV-QP-045.0 for the solar panel, battery configuration, and type of sampler being installed. Has wiring been completed according to instructions? | <input type="checkbox"/> Yes <input type="checkbox"/> No |
| Is the sampler installed according to steps in ENV-QP-045.0? | <input type="checkbox"/> Yes <input type="checkbox"/> No |
| Is a Greenlee box used? | <input type="checkbox"/> Yes <input type="checkbox"/> No |
| Are electrical connections secure? | <input type="checkbox"/> Yes <input type="checkbox"/> No |
| Record battery voltage(s). Voltage(s) > 11.7 V? | <input type="checkbox"/> Yes <input type="checkbox"/> No |
| Is the sampler physically configured for the types and number of bottles specified above (i.e., correct carousel, base, arm)? | <input type="checkbox"/> Yes <input type="checkbox"/> No |
| Is the sampler programmed correctly per ENV-QP-045.0 for the program / bottle set specified above? | <input type="checkbox"/> Yes <input type="checkbox"/> No |
| Does sampler pass the ISCO diagnostics test? | <input type="checkbox"/> Yes <input type="checkbox"/> No |
| Does sample tubing pass suction test? | <input type="checkbox"/> Yes <input type="checkbox"/> No |
| Is sampler ON upon departure? | <input type="checkbox"/> Yes <input type="checkbox"/> No |
| Does ISCO display either "Sampler Inhibited" or "Program Disabled"? | <input type="checkbox"/> Yes <input type="checkbox"/> No |
| Has the actuator switch been reset to "Latch"? | <input type="checkbox"/> Yes <input type="checkbox"/> No |
| If any maintenance completed, check YES and describe. | <input type="checkbox"/> Yes <input type="checkbox"/> No |
| If any follow-on maintenance is required, check YES and describe. | <input type="checkbox"/> Yes <input type="checkbox"/> No |

LANL PERSONNEL USE ONLY (Initials and dates)		
Accepted	Tech QC	ENV-RCRA Review

ATTACHMENT 2- WIRING DIAGRAM FOR AVALANCHE SAMPLER

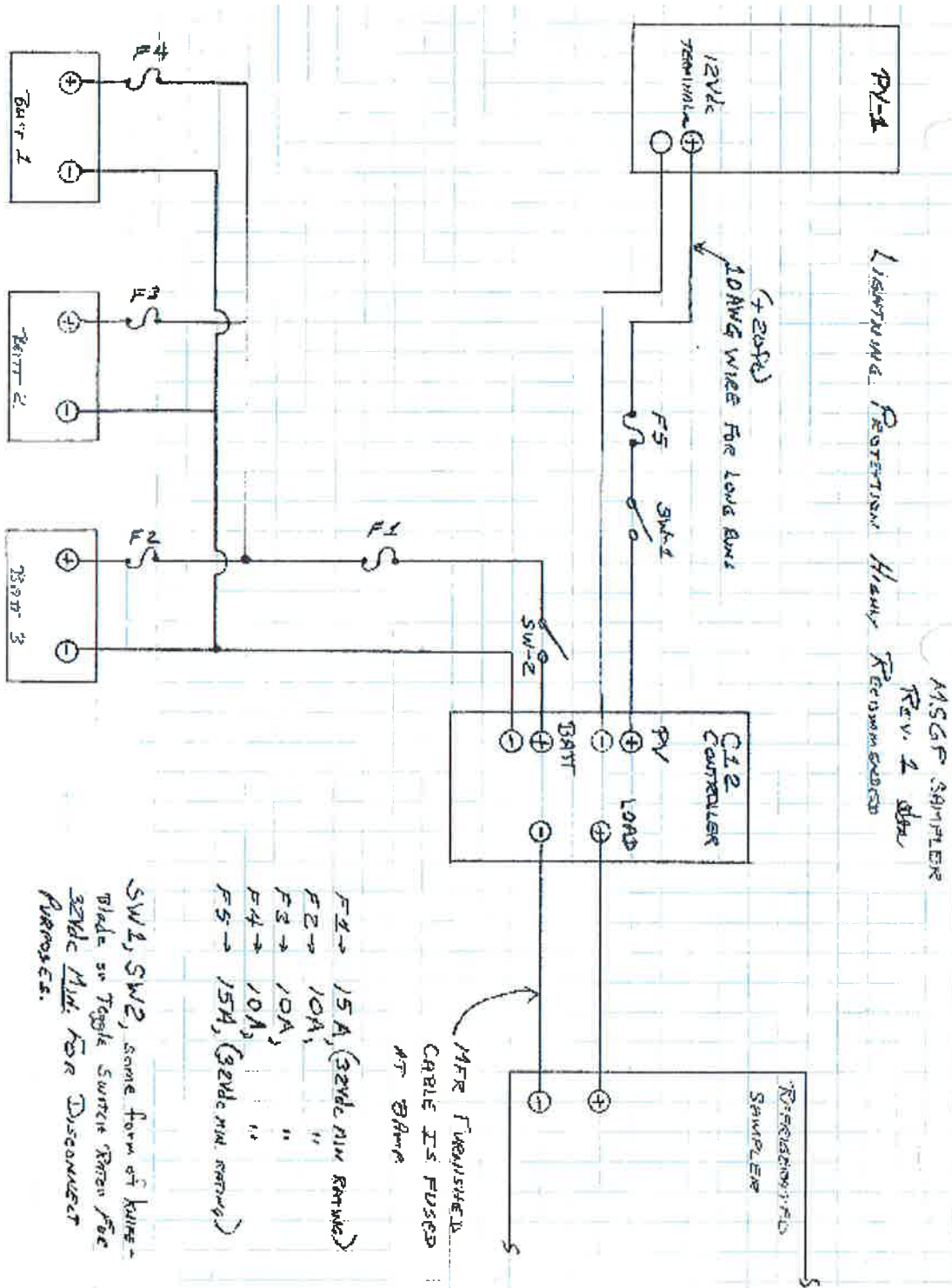

ATTACHMENT 3 – BATTERY PHOTOVOLTAIC CONNECTION WIRING

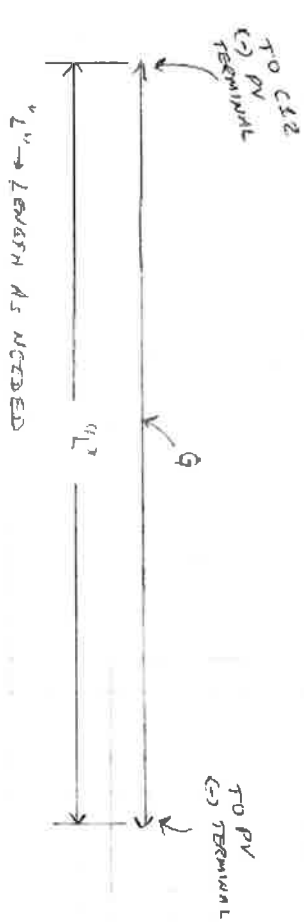

NOTE: LENGTHS OF L1 & L2 SHOULD BE KEPT AS SHORT AS POSSIBLE BUT NOT LESS THAN 1/8" TO FACILITATE WIRE DISCONNECTIONS.

L1 -> LENGTH AS NEEDED TO POSITION FUSE IN AN ACCESSIBLE LOCATION FOR DISCONNECTING & REPLACING

L2 -> 12" -> 18"

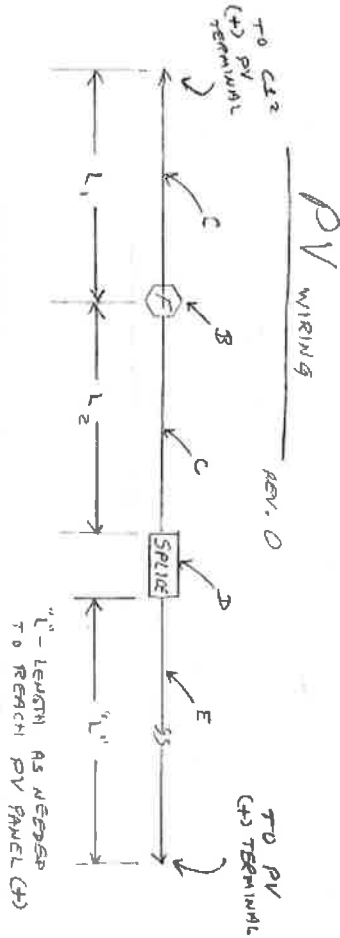

- ITEM
- B - FUSE HOLDER
 - C - 12 AWG WIRE (RED)
 - D - BRACKET (BUT) SPLICE INSULATED
 - E - 10 AWG WIRE (RED)
 - G - 10 AWG WIRE (BLACK)

BATTERY CABLE OPTIONS

REV. 0

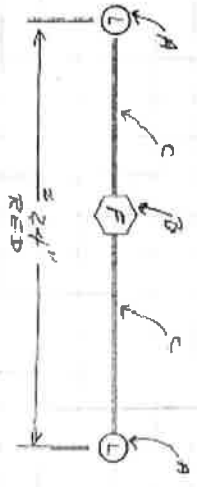

INTERMEDIATE TERMINAL BATTERY CONNECTIONS

- ITEM
- A - Terminal Lug
 - B - FUSE HOLDER
 - C - 12 AWG WIRE 12" (RED)
 - D - BARE (ROUND) SPICE INSULATOR
 - E - 20 AWG WIRE (RED)
 - F - 12 AWG WIRE 24" (BLACK)

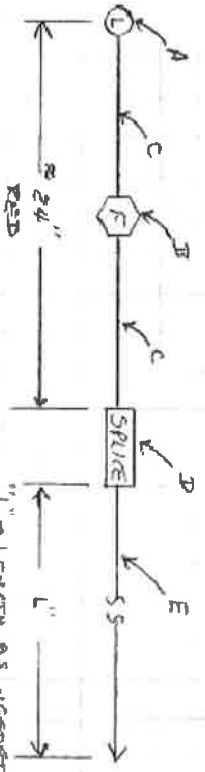

"1" LENGTH AS NEEDED TO REACH CHARGE CABLE

FROM LAST BATTERY (+) TERMINAL TO (+) BATT INPUT OF C&Z CHRG CABLE

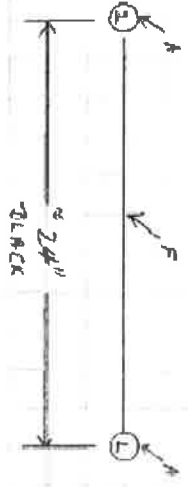

INTERMEDIATE TERMINAL BATTERY CONNECTIONS

FROM LAST BATTERY (-) TERMINAL TO (-) BATT INPUT OF C&Z CHRG CABLE

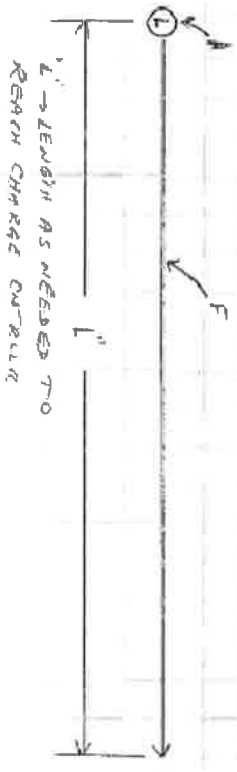

"1" LENGTH AS NEEDED TO REACH CHARGE CABLE

ATTACHMENT 4 - ISCO 3700 CONFIGURATION SETTINGS

Parameter	Storm sampling with multiplex, timed delay	Time sampling with multiplex	Flow sampling with multiplex
Time/ Date	[Set to MST]	[Set to MST]	[Set to MST]
Portable/ Refrig	Portable	Portable	Portable
Bottles	12 or 24	12 or 24	12 or 24
Bottle volume	950 ml	1000 ml	1000 ml
Suction line diameter	3/8 inch	3/8 inch	3/8 inch
Suction line type	Teflon	Teflon	Teflon
Suction line length	X feet	X feet	X feet
Liquid detector	Enable	Enable	Enable
Rinse cycles	0	1	1
Enter Head Manually	No	Yes	Yes
Retry	1	1	1
Program mode	Extended	Basic	Basic
Load program	None	N/A	N/A
Save program as	None	N/A	N/A
Take sample at start time	No	N/A	N/A
Take sample at time switch	No	N/A	N/A
Enter intervals in minutes	1 minute	N/A	N/A
Calibrate sampler	Disable	Enable	Enable
Sampling stop/resume	Disable	N/A	N/A
Start time delay	0 minutes	0 minutes	0 minutes
Master slave	No	No	No
Sample upon Disable	No	No	No
Sample upon enable	No	Yes	Yes
Reset sample interval	Yes	Yes	No
Inhibit countdown	Yes	Yes	No
Event marker	Pulse	Pulse	Pulse
At the beginning of:	Purge	Purge	Purge
Purge counts presample counts	150	100	100
Post sample counts	394	1000	1000
Pump counts	[500,000]	[500,000]	[500,000]
Reset pump counter	No	No	No
Pump counts to warning	500,000	500,000	500,000
Program lock	Disable	Disable	Disable
Sampler ID number is:	[leave blank]	[leave blank]	[leave blank]
Run diagnostics	Yes	Yes	Yes
Test distributor	Yes	Yes	Yes
Re-initialize	No	No	No

ATTACHMENT 5 – ISCO 3700 PROGRAM SEQUENCE

Parameter	Storm sampling with multiplex, timed delay
[Switch on liquid actuator]	Set to "Latch"
Paced sampling	Storm
Time Mode 1st Bottle Group	X-minute delay
Timed Sample Event	1
Bottle per sample event	11 or 23
Sample volume	950 ml
Bottles available	1
2 nd bottle group	Time
2 nd group samples	1-minute delay
Sample interval	1 minute
Bottles per sampling event	1
Sample per bottle	1
Sample volume	950 ml
Enter start time	No

[Programming complete]

Parameter	Time sampling with multiplex
[Switch on liquid actuator]	Set to "Latch"
Time/Flow	Time
Min/Hr	1 min
Multiplex samples	Yes
Bottles/sample or Samples/Bottle	Bottles/ sample
Number of bottles	12 or 24
Sample volume	1000 ml
Suction head	XX Ft
Calibrate sample vol	No
Enter start time	No

[Programming complete]

Avalanche Program Sequence, cont.

Parameter	Time sampling, single bottle composite sample	Time sampling, 1-part program	Time sampling, 2-part program
Two-Part Program			
Part A	N/A	N/A	Yes
Assign bottle	N/A	N/A	1-X of 4 or 14
Pacing	N/A	N/A	Uniform time paced
Time between samples	N/A	N/A	1 minute
Distribution	N/A	N/A	Sequential
Bottles per event	N/A	N/A	1
Switch bottles on	N/A	N/A	Number of samples
Switch bottles every X samples	N/A	N/A	1
Run continuously	N/A	N/A	No
Sample volumes dependent on flow?	N/A	N/A	No
Sample volume	N/A	N/A	Select between 10 ml and full container volume
Enable programmed	N/A	N/A	None
Once enabled, stay enabled	N/A	N/A	Yes
Sample at enable	N/A	N/A	Yes
Sample at disable	N/A	N/A	No
Pauses and resumes	N/A	N/A	0
Part B	N/A	N/A	Yes
Pacing	N/A	N/A	Uniform time paced
Time between sample events	N/A	N/A	1 minute
Distribution	N/A	N/A	Sequential
Bottles per event	N/A	N/A	1
Switch bottles on	N/A	N/A	Number of samples
Switch bottles every X samples	N/A	N/A	1
Run continuously	N/A	N/A	No
Sample volumes dependent on flow?	N/A	N/A	No
Sample volume	N/A	N/A	Select between 10 ml and full container volume
Enable programmed	N/A	N/A	No

Avalanche Program Sequence, cont.

Parameter	Time sampling, single bottle composite sample	Time sampling, 1- part program	Time sampling, 2-part program
Once enabled, stay enabled	N/A	N/A	Yes
Sample at disable	N/A	N/A	No
Sample at enable	N/A	N/A	Yes
Once enabled, stay enabled	N/A	N/A	Yes
Pauses and resumes	N/A	N/A	0
Delay to start	N/A	N/A	No
Reset Sampler			
Switch on liquid actuator	Toggle to "Reset" then back to "Latch"	Toggle to "Reset" then back to "Latch"	Toggle to "Reset" then back to "Latch"
Select Program name	Run	Run	Run

ATTACHMENT 6 – LANL MSGP ISCO SAMPLER ACTIVATION FORM 045-3

ENV-QP-045.0

**LANL Multi-Sector General Permit
ISCO Sampler Activation Form**

Form 045-3 (3/2011)

Outfall: **3-PSP-5 : E121.9-ISCO 12**

Project ID: **P-MSGP-830**

Work Order ID: **MSGP-12785**

Target Date: **4/11/2011**

Project: **MSGP Sampler Activation Q1 2011**

Reason: **MSGP Sampler Activation 2011 Q1**

Date: _____ Time: _____
 Name/Z#: _____
 Name/Z#: _____
 Lead Signature: _____
 I confirm the information as recorded is true, accurate and complete.

Equipment	Manufacturer	Model	Serial No.	Specification	Configuration
Actuator	ISCO	1640		Actuator Height	
ISCO Sampler 12c	Teledyne ISCO	ISCO 3700	198H01553	Bottle Set	12c- 1 1L Poly
ISCO Sampler 12c	Teledyne ISCO	ISCO 3700	198H01553	Program	Time / Multiplex no delay
Pb-Acid Battery				Voltage	> 11.7 V

ISCO Sampler Tasks

Note: If "No" provide correct information or explanation.

- Is the ISCO time delta < 1 min (MST)? If no, record adjustment. Yes No
- Does sampler pass the ISCO diagnostics test? Yes No
- Are electrical connections secure? Yes No
- Record battery voltage(s). Is/are voltage(s) > 11.7 V? Yes No
- Does ISCO display either "Bottle 1 of X after 1" or "Sampler Inhibited"? Yes No
- Is bottle set described above installed? Yes No
- Is recorded height of actuator above channel bottom correct? Yes No
- If any maintenance completed, check Yes: Describe. Yes No
- If any follow-on maintenance is required, check Yes: Describe. Yes No
- Is sampler ON upon departure? Yes No

Additional Notes:

LANL PERSONNEL USE ONLY (Initials and dates)		
Accepted	Tech QC	RNV-RCRA Review

ATTACHMENT 7 – ISCO AVALANCHE CONFIGURATION SETTINGS

ISCO Avalanche Configuration Settings

Parameter	All programs
Maintenance	
Set Clock	[Set to MST]
Pump Tube Alarm	[1,000,000]
Reset pump counter	No
Run diagnostics	Yes
Re-initialize	No
Software Options	
Liquid detector	Liquid detect on
Target temperature	°C
Measurement interval	1 minute
Dual sampler mode	Off
Bottle full detect	Yes
Event mark	Every sample
Duration	3 second pulse at initial purge
Presample purge counts	100
Post sample counts	Dependent on head
Periodic serial output	No
Interrogator connector power	Alarm dial-outs only
Manual Functions	
Grab Sample	Manual option
Calibrate volume	Manual option
Operate pump	Manual option
Move distributor	Manual option
Other Settings/Misc	
Suction line diameter	3/8 inch
Suction line type	Teflon
Program lock	Disable

ATTACHMENT 8 – ISCO AVALANCHE PROGRAM SEQUENCE

Parameter	Time sampling, single bottle composite sample	Time sampling, 1- part program	Time sampling, 2- part program
Program			
Program mode	Extended	Extended	Extended
Program name	COMPOSITE	1-PART (# bottles)	2-PART (# bottles)
Site description	Station number	Station number	Station number
Units (length)	ft	ft	ft
Units (temperature)	°C	°C	°C
Data storage interval	1 minute	1 minute	1 minute
Number of bottles	1	4 or 14	4 or 14
Bottle volume	10000 ml, 4000 ml	2000 ml, 950 ml	2000 ml, 950 ml
Suction line length	X feet	X feet	X feet
Enter Head Manually	Yes	Yes	Yes
Rinse cycles	1	1	1
Retries	1	1	1
One-Part Program			
Pacing	Uniform time paced	Uniform time paced	N/A
Time between samples	Every one minute	Every one minute	N/A
Composite	1 sample	N/A	N/A
Run continuously	No	N/A	N/A
Take X sample(s)	1	N/A	N/A
Distribution	N/A	Sequential	N/A
Volume	Select between 10 ml and full container volume	Select between 10 ml and full container volume	N/A
Sample volumes dependent on flow	No	No	N/A
Enable programmed	None	None	N/A
Once enabled, stay enabled	Yes	Yes	N/A
Sample at enable	Yes	Yes	N/A
Sample at disable	No	No	N/A
Pauses and resumes	0	0	N/A
Delay to start	No	No	N/A

ATTACHMENT 9 – LANL MSGP ISCO SAMPLER WINTER SHUT-DOWN FORM 045-5

ENV-QP-045.0

**LANL Multi-Sector General Permit
ISCO Sampler Winter Shutdown Form**

Form 045-5 (3/2011)

Outfall: **3-PSP-5 : E121.9-ISCO 12**

Project ID: **P-MSGP-833**

Work Order ID: **MSGP-12803**

Target Date: **11/30/2011**

Project: **MSGP ISCO Sampler Winter Shutdown**

Reason: **MSGP Sampler Winter Shutdown 2011**

Date: _____	Time: _____
Name/Z#: _____	
Name/Z#: _____	
Lead Signature: _____	
I confirm the information as recorded is true, accurate and complete.	

Verify the equipment list below. Make corrections as required and fill in missing information (e.g., serial numbers).

Equipment	Manufacturer	Model	Serial No.	Specification	Configuration
Actuator	ISCO	1640		Actuator Height	
ISCO Sampler 12c	Teledyne ISCO	ISCO 3700	198H01553	Bottle Set	12c- 1 1L Poly
ISCO Sampler 12c	Teledyne ISCO	ISCO 3700	198H01553	Program	Time / Multiplex no delay
Pb-Acid Battery				Voltage	> 11.7 V

ISCO Sampler Tasks	Note: If "No" provide correct information or explanation.
Turn ISCO unit "OFF."	<input type="checkbox"/> Yes <input type="checkbox"/> No
Place caps securely on bottles in the sample carousel.	<input type="checkbox"/> Yes <input type="checkbox"/> No
Verify equipment list above.	<input type="checkbox"/> Yes <input type="checkbox"/> No
ISCO 3700 Sampler Units	
Disconnect and remove battery. Transport battery to MSGP stockroom for maintenance and storage.	<input type="checkbox"/> Yes <input type="checkbox"/> No
Place battery cables securely inside Greenlee box or ISCO casing.	<input type="checkbox"/> Yes <input type="checkbox"/> No
Pull up actuator and tubing and store in Greenlee box or ISCO casing.	<input type="checkbox"/> Yes <input type="checkbox"/> No
Avalanche ISCO Sampler Units:	
Disconnect and remove batteries. Transport batteries to MSGP stockroom for maintenance and storage.	<input type="checkbox"/> Yes <input type="checkbox"/> No
Place battery cables securely inside Greenlee box or ISCO casing.	<input type="checkbox"/> Yes <input type="checkbox"/> No
Pull up actuator and tubing and store inside Greenlee box or ISCO casing.	<input type="checkbox"/> Yes <input type="checkbox"/> No
Transport Avalanche sampler to MSGP stockroom for maintenance and storage.	<input type="checkbox"/> Yes <input type="checkbox"/> No

Additional Notes:

LANL PERSONNEL USE ONLY (initials and dates)		
Accepted	Tech QC	ENV-RCRA Review

ATTACHMENT 10 – LANL MSGP ISCO SAMPLER DECOMMISSION FORM 045-6

ENV-QP-045.0

**LANL Multi-Sector General Permit
ISCO Sampler Decommission Form**

Form 045-6 (3/2011)

Outfall: **3-PSP-5 ; E121.9-ISCO 12**

Project ID: **P-MSGP-834**

Work Order ID: **MSGP-12804**

Target Date: **7/27/2011**

Project: **MSGP Sampler Station Decommission**

Reason: **MSGP Sampler Decommission**

Date: _____	Time: _____
Name/Z#: _____	
Name/Z#: _____	
Lead Signature: _____	
I confirm the information as recorded is true, accurate and complete.	

Verify the equipment list below. Make corrections as required and fill in missing information (e.g., serial numbers).

Equipment	Manufacturer	Model	Serial No.	Specification	Configuration
Actuator	ISCO	1640		Actuator Height	
ISCO Sampler 12c	Teledyne ISCO	ISCO 3700	198H01553	Bottle Set	12c- 1 1L Poly
ISCO Sampler 12c	Teledyne ISCO	ISCO 3700	198H01553	Program	Time / Multiplex no delay
Pb-Acid Battery				Voltage	> 11.7 V

ISCO Sampler Tasks	Note: If "No" provide correct information or explanation.
Is equipment list above complete and accurate?	<input type="checkbox"/> Yes <input type="checkbox"/> No
Turn sampler *OFF.* Remove bottles from carousel.	<input type="checkbox"/> Yes <input type="checkbox"/> No
Disconnect and remove battery(ies), solar panel, and cables (as applicable).	<input type="checkbox"/> Yes <input type="checkbox"/> No
Pull up actuator and tubing. Disconnect from sampler unit.	<input type="checkbox"/> Yes <input type="checkbox"/> No
Uninstall Greenlee box, as applicable.	<input type="checkbox"/> Yes <input type="checkbox"/> No
Transport all removed equipment to the MSGP stockroom for maintenance and storage.	<input type="checkbox"/> Yes <input type="checkbox"/> No

Additional Notes:

LANL PERSONNEL USE ONLY (initials and dates)		
Accepted _____	Tech QC _____	ENV-RCRA Review _____

ENV-CP-QP-048.1



Effective Date: September 5, 2013

Next Review Date: August 5, 2015

Environment, Safety, Health Directorate

**Environmental Protection – Compliance Programs
Quality Procedure**

Processing MSGP Stormwater Samples

Reviewers:

Name:	Organization:	Signature:	Date:
Melanie Lamb	ADESH-OIO, QA Specialist	Signature on file	8/28/13

Derivative Classifier: **Unclassified** **DUSA_ ENVPRO**

Name:	Organization:	Signature:	Date:
Ellena Martinez	ADESH-OIO	Signature on file	8/29/13

Approval Signatures:

Subject Matter Expert: Holly Wheeler	Organization: ENV-CP	Signature: Signature on file	Date: 8/29/13
Responsible Line Manager: Michael Saladen	Organization: ENV-CP Team Lead	Signature: Signature on file	Date: 8/29/13
Responsible Line Manager: Anthony Grieggs	Organization: ENV-CP Group Leader	Signature: Signature on file	Date: 9/5/13

CONTROLLED DOCUMENT

This copy is uncontrolled. The controlled copy can be found on the ENV Division Web page.

Users are responsible for ensuring they work to the latest approved version.

Processing MSGP Stormwater Samples	No. ENV-CP-QP-048.1	Page 2 of 11
	Effective Date: September 5, 2013	

History of Revisions

Document Number <i>[Include revision number, beginning with Revision 0]</i>	Effective Date <i>[Document Control Coordinator inserts effective date]</i>	Description of Changes <i>[List specific changes made since the previous revision]</i>
0	07/11	New Document.
1	09/13	Annual Review and Revision, new format, process change, and new organization name.

Table of Contents

1.0 PURPOSE.....4

2.0 SCOPE4

 2.1 Hazard review4

3.0 RESPONSIBILITIES4

 3.1 Prerequisites4

4.0 DOCUMENT CONTROL/RECORDS MANAGEMENT4

5.0 WORK PROCESSES5

 5.1 Processing Samples5

 5.2 Submit Samples for Shipping6

 5.3 Data Quality Objectives7

 5.4 Develop a Decision Rule.....8

6.0 REFERENCES.....8

7.0 DEFINITIONS9

8.0 ATTACHMENTS9

 Attachment 1- Sample Collection Log/Field Chain of Custody Form10

 Attachment 2- Sample Container Labels11

Processing MSGP Stormwater Samples	No. ENV-CP-QP-048.1	Page 4 of 11
	Effective Date: September 5, 2013	

1.0 PURPOSE

This procedure describes the process for preserving stormwater samples for shipment to an offsite analytical laboratory.

2.0 SCOPE

This procedure applies to all LANL personnel and subcontractors who conduct chemical preservation of stormwater samples either in the stormwater Laboratory located in TA-59-1 or out in the field.

2.1 HAZARD REVIEW

The work specified in this procedure is conducted in accordance with the following integrated work documents: IWDs 007, 007a, 007b, 007c, 007d, 007e, 007f, 008, 010, 010b, and 010c. Each IWD is associated with a specific FOD depending on location of sample activity. The hazard level of this procedure is **MODERATE**.

3.0 RESPONSIBILITIES

The following personnel require training before implementing this procedure:

- ENV-CP staff and contract personnel who process Stormwater samples for the MSGP.

The training method for this procedure is “self-study” (reading). For ENV-CP staff, this is documented in accordance with ENV-DO-QP-115, *Personnel Training*. Other participating groups may require training documentation pursuant to local procedures.

Actions specified within this procedure, unless proceeded with “should” or “may,” are to be considered mandatory (i.e., “shall”, “will”, “must”).

3.1 PREREQUISITES

In addition to training to this procedure, the following training and data systems access is also required prior to performing this procedure:

- Personnel performing this procedure will be familiar with the most recent version of the ENV-CP MSGP Sampling and Analysis Plan.
- WES-EDA-QP-219, *Sample Control and Field Documentation*
- ENV-RCRA-QP-022, *MSGP Stormwater Corrective Action*

4.0 DOCUMENT CONTROL/RECORDS MANAGEMENT

The following records are generated as a result of this procedure and are maintained in accordance with ENV-DO-QP-110, *Records Management Program* with the originals on file at ENV-CP records room:

- Copy of the Sample Collection Log/Field Chain of Custody Form

5.0 WORK PROCESSES

The Environmental Protection Agency (EPA) issued the National Pollutant Discharge Elimination System (NPDES) Multi-Sector General Permit (MSGP) on September 29, 2008. The MSGP requires LANL to monitor stormwater runoff from industrial sites relative to potential pollutants.

Stormwater samples are collected in the field either from refrigerated Avalanche™ or ISCO 3700™ automated samplers. Chemical preservation is conducted in the Stormwater Laboratory (in TA-59-01) immediately following sample collection or in the field.

A LANL Project Leader is the primary person responsible for the steps in this procedure.

The following equipment and tools are required:

- Copy of this procedure
- Copy of Integrated Work Documents (IWDs)
- Copy of the ENV-CP MSGP Sampling and Analysis Plan
- Work Orders (if issued)
- Sample Collection Log/Field Chain of Custody Form (provided by the Sample Management Office (SMO))
- Sample containers
- Sample container labels
- Necessary keys
- Safety glasses with side shields
- Nitrile gloves
- Leather gloves or equivalent work gloves
- Glass and poly bottles appropriate for samples to be collected at the site (reference sampling plan)
- Preservative
- Lids for bottles
- Teflon tubing for intake
- Tygon tubing for exhaust

5.1 PROCESSING SAMPLES

Step	Action
1	Obtain required Sample Collection Log/Field Chain of Custody Form(s) from the SMO. Collect samples and deliver them to the Water Laboratory in coolers containing Blue Ice®.
2	Double check to make sure the Location ID on the Sample Collection Log/Field Chain of Custody Form matches the sample collection station number. If preservation beyond ice is indicated on the form, obtain required preservative and sample containers for identified volume if different from the amount of sample collected. NOTE: Specific preservatives and required sample volumes are listed on the Sample Collection Log/Field Chain of Custody Form.
3	Process only one sample set (i.e., samples from one site) at a time. NOTE: Sample collection bottles are the bottles used to collect the sample in the field. Sample containers are containers/bottles that the original sample is transferred to after processing. These

	containers are transferred to the Sample Management Office for shipment to the analytical laboratory.
4	Affix appropriate label to sample container.
5	Split up samples into appropriate sample containers.
6	Verify that the sample ID number on the container label matches the sample ID number on the Sample Collection Log/Filed Chain of Custody Form

The following steps should be followed when preserving samples:

Step	Action
1	IMPORTANT: Preservation entails the addition of acid or base to a sample. Acids used include hydrochloric acid (HCl), nitric acid (HNO ₃), and sulfuric acid (H ₂ SO ₄). Bases used in preservation include sodium hydroxide (NaOH). These are all strong acids and bases that can cause severe burns. Extreme care should be taken when using these acids and bases.
2	Preserve (add acid or base) samples according to the requirements on the Sample Collection Log/Field Chain of Custody Form. NOTE: Make sure the pre-measured preservative labeled size matches the sample container size. If you only have one size pre-measured preservative that does not match the sample container size you may need to use more than one. For example, if you have a 1 liter sample container and 500 ml pre-measured preservative vial, you would need to add two preservative vials to the sample container.
3	Mark each container after preservative has been added to designate that the process has taken place.
4	Securely affix lid to sample container. Clean and dry the exterior of sample container, ensure lid is on securely, and check sample container for leakage and breakage.
5	Apply chain-of-custody tape around the mouth and lid of the bottle.
6	Carefully place sample containers in the cooler and package sample containers with Blue Ice [®] .

5.2 SUBMIT SAMPLES FOR SHIPPING

Submit samples with original Sample Collection Log/Field Chain of Custody Form to SMO for shipping to an offsite analytical laboratory. The person delivering the sample to SMO relinquishes the sample by signing, dating and recording the time under "Relinquished By." The SMO accepts samples by signing, dating and recording the time under "Received By." Obtain a signed copy of the Sample Collection Log/Field Chain of Custody Form from the SMO. Make a copy of the Sample Collection Log/Field Chain of Custody Form and provide it to the MSGP Project Leader.

Every attempt will be made to minimize the amount of waste generated. Field personnel will diligently collect only the volumes identified as the minimum or maximum allowable identified on Form. If there is not enough liquid collected to meet these volumes, the Stormwater will be

Processing MSGP Stormwater Samples	No. ENV-CP-QP-048.1	Page 7 of 11
	Effective Date: September 5, 2013	

discharged at the sampler location. Extra Stormwater collected will also be discharged at the sampler location. If waste is generated, contact the Waste Management Coordinator for TA-59-1 or the MSGP Project Leader.

5.3 DATA QUALITY OBJECTIVES

The 2008 MSGP permit requires quarterly and annual Stormwater monitoring to determine if pollutants from industrial activities are migrating into U.S. waters. The permit specifies benchmark parameters that are indicators of potential pollutant sources. In addition, certain impaired water quality standards must be met. Factors which must be considered in making the decision of whether pollutant sources are present or water quality standards have been exceeded are analytical data quality and whether the collected sample is representative of the permitted discharge.

To determine whether the Laboratory is in compliance with all relevant laws and regulations, sample collection and analytical data must be evaluated by the a representatives of ADESH, Operations and Integration Office (OIO) by requesting formal focused validation and/or by the MSGP Project Leader.

Sample collection and submission is conducted under the guidelines found in:

- NPDES Permit Tracking No. NMR05GB21
- 40 CFR Subpart 136 Guidelines establishing the test procedure for the analysis of pollutants.

Sample analysis must use EPA approved methods as set forth in the NPDES permit.

Benchmark levels are identified in the 2008 MSGP. Outfall and sampling locations are identified in the individual facility Stormwater Pollution Prevention Plans (SWPPP).

Monitoring frequencies and reporting requirements are specified in the 2008 MSGP.

Sampling location(s):

Annual, quarterly, and visual assessments shall be conducted in compliance with the monitoring requirements specified in the 2008 MSGP. As specified previously, specific sampling location(s) are identified in the facility specific SWPPP.

Grab Sample:

A minimum of one grab sample from a discharge resulting from a measurable storm event is required. Samples must be collected within the first 30 minutes of a measurable storm event. If that is not possible, the sample must be collected as soon as practicable after the first 30 minutes and documentation must be kept with the SWPPP explaining why it was not possible to take samples within the required time frame. In the case of snowmelt, samples must be taken during a period with a measurable discharge.

Processing MSGP Stormwater Samples	No. ENV-CP-QP-048.1	Page 8 of 11
	Effective Date: September 5, 2013	

NOTE: A grab sample is defined as a single sample collected at a NPDES outfall (using approved EPA methods) at a particular time that represents the composition of the stormwater at that time and place.

Representative Sampling:

Samples and measurements taken for the purpose of monitoring shall be representative of the monitored activity.

MSGP Discharge Monitoring Reports and Other Reports (MDMRS):

Monitoring results must be reported on an MDMR form (EPA Form No. 2040-0004) in accordance with the “Instructions for Completing the MSGP Industrial Discharge Monitoring Report” provided on the form. The permittee shall submit the original MDMR signed and certified to EPA as required by Part 7.1 of the MSGP.

Duty to Comply:

The permittee must comply with all conditions of the 2008 MSGP permit. Any permit noncompliance constitutes a violation of the Act and is grounds for enforcement action.

5.4 DEVELOP A DECISION RULE

If analytical results from monitoring activities are above benchmark and/or natural background levels, a corrective action is entered into the ENV-CP Corrective Action Report Database, in accordance with *ENV-RCRA-QP-022, MSGP Stormwater Corrective Actions*. An e-mail is automatically generated and sent to personnel responsible for evaluating and modifying controls to prevent further exceedances. Data validation is conducted under the guidelines of the DOE Statement of Work.

Acceptable analytical error is addressed in the DOE Statement of Work.

The current MSGP monitoring program is based on the 2008 MSGP. Activities that could affect the current or next MSGP permit include:

- Addition or removal of constituents into the 303(b) list,
- Discontinued monitoring based on no detection or constituent levels below benchmark or natural background,
- Specific changes identified by EPA within the next permit,
- DOE Statement of Work requirement for analytical laboratories.

6.0 REFERENCES

None

Processing MSGP Stormwater Samples	No. ENV-CP-QP-048.1	Page 9 of 11
	Effective Date: September 5, 2013	

7.0 DEFINITIONS

None

8.0 ATTACHMENTS

Attachment 1- Example Sample Collection Log/Field Chain of Custody Form

Attachment 2- Sample Container Labels

By requesting credit for this required reading I acknowledge that I have read and understand the contents of this document and I will follow and meet the requirements in this document unless it is unsafe to do so.

[Click to Acknowledge](#)

ATTACHMENT 1- SAMPLE COLLECTION LOG/FIELD CHAIN OF CUSTODY FORM

Los Alamos National Laboratory

Page 1 of 1

SAMPLE COLLECTION LOG/FIELD CHAIN OF CUSTODY

EVENT ID: 4179 **EVENT NAME:** MSGP - 2013
SAMPLE ID: WTMSGP-13-29841 **WORK ORDER:**

<u>AS PLANNED</u>		<u>AS COLLECTED</u>	<u>AS PLANNED</u>		<u>AS COLLECTED</u>
DATE COLLECTED (MM/DD/YYYY):		08/10/13	FIELD MATRIX:	WT	OK
TIME COLLECTED (HH:MM):		1334	MEDIA:		
PRS ID:		OK	SAMPLE TECH CODE:	APS	
LOCATION ID:	03-0038W	OK	FIELD PREP:	UF	
LOCATION TYPE:			FIELD QC TYPE:	REG	
TOP DEPTH:			SAMPLE USAGE:	COMP	
BOTTOM DEPTH:			EXCAVATED:		YES / NO <u>NA</u>

PRIORITY	ORDER	CONTAINER	#	PRESERVATIVE	COLLECTED Y/N	SPECIAL INSTRUCTIONS
	MSGP-Zn	1 LITER POLY	1	HNO3	Y	

SAMPLE COMMENTS:

Q3

LOCATION COMMENTS:

FIELD PARAMETERS:

COLLECTED BY (PRINT) MARWIN SHENDO

RELINQUISHED BY (Printed Name) <i>Marwin Shendo</i> (Signature) <i>[Signature]</i>	Date/Time 8/20/13 11:45	RECEIVED BY (Printed Name) <i>S. Sherwood</i> (Signature) <i>[Signature]</i>	Date/Time 8/20/13 11:45
RELINQUISHED BY (Printed Name) (Signature)	Date/Time	RECEIVED BY (Printed Name) (Signature)	Date/Time

Report Date 08/01/2013

COPY

ATTACHMENT 2- SAMPLE CONTAINER LABELS

www.avery.com

1-800-GO-AVERY (462-8379)

55231™



Los Alamos National Laboratory	
Sample ID: WTMSGP-13-29858	
Container: 1 LITER POLY	1 of 1
Preservative: HNO3	
Analysis: Ag+As+Cd+Mg+Pb+Se+Hg	
Date:	Time:

Los Alamos National Laboratory	
Sample ID: WTMSGP-13-29858	
Container: 0.5 LITER POLY	1 of 1
Preservative: NAOH	
Analysis: MSGP-CN(TOTAL)	
Date:	Time:

Los Alamos National Laboratory	
Sample ID: WTMSGP-13-29858	
Container: 0.5 LITER POLY	1 of 1
Preservative: H2SO4	
Analysis: MSGP-COD	
Date:	Time:

Los Alamos National Laboratory	
Sample ID: WTMSGP-13-29858	
Container: 0.5 LITER POLY	1 of 1
Preservative: H2SO4	
Analysis: MSGP-NH3-N	
Date:	Time:

Los Alamos National Laboratory	
Sample ID: WTMSGP-13-29858	
Container: 1 LITER POLY	1 of 1
Preservative: HNO3	
Analysis: MSGP-GrossA	
Date:	Time:

Los Alamos National Laboratory	
Sample ID: WTMSGP-13-29858	
Container: 1 LITER GLASS	1 of 3
Preservative: ICE	
Analysis: MSGP-PCB(Aroclor)	
Date:	Time:

Los Alamos National Laboratory	
Sample ID: WTMSGP-13-29858	
Container: 1 LITER GLASS	2 of 3
Preservative: ICE	
Analysis: MSGP-PCB(Aroclor)	
Date:	Time:

Los Alamos National Laboratory	
Sample ID: WTMSGP-13-29858	
Container: 1 LITER GLASS	3 of 3
Preservative: ICE	
Analysis: MSGP-PCB(Aroclor)	
Date:	Time:

Los Alamos National Laboratory	
Sample ID: WTMSGP-13-29858	
Container: 1 LITER POLY	1 of 1
Preservative: HNO3	
Analysis: Ag+As+Cd+Mg+Pb+Se+Hg	
Date:	Time:

Los Alamos National Laboratory	
Sample ID: WTMSGP-13-29858	
Container: 0.5 LITER POLY	1 of 1
Preservative: NAOH	
Analysis: MSGP-CN(TOTAL)	
Date:	Time:



Effective Date: May 14, 2013

Next Review Date: April 14, 2015

Environment, Safety, Health Directorate

**Environmental Protection – Water Quality and RCRA
Quality Procedure**

**Inspecting Storm Water Runoff Samplers and
Retrieving Samples for the MSGP**

Reviewers:

Name:	Organization:	Signature:	Date:
Melanie Lamb	ENV-QPMO QA Specialist	Signature on file	3/7/13

Derivative Classifier: **Unclassified** **DUSA**_____

Name:	Organization:	Signature:	Date:
Anthony Grieggs	ENV-RCRA	Signature on file	5/14/13

Approval Signatures:

Subject Matter Expert: Holly Wheeler	Organization: ENV-RCRA	Signature: Signature on file	Date: 3/20/13
Responsible Line Manager: Terrill Lemke	Organization: ENV-RCRA Team Lead	Signature: Signature on file	Date: 5/3/13
Responsible Line Manager: Anthony Grieggs	Organization: ENV-RCRA Group Leader	Signature: Signature on file	Date: 5/14/13

CONTROLLED DOCUMENT

This copy is uncontrolled. The controlled copy can be found on the ENV Division Web page.

Users are responsible for ensuring they work to the latest approved version.

History of Revisions

Document Number <i>[Include revision number, beginning with Revision 0]</i>	Effective Date <i>[Document Control Coordinator inserts effective date]</i>	Description of Changes <i>[List specific changes made since the previous revision]</i>
0	03/11	New Document.
1	02/13	Annual Review and Revision

Table of Contents

1.0	PURPOSE	4
2.0	SCOPE	4
2.1	Hazard review	4
3.0	RESPONSIBILITIES	4
3.1	Prerequisites	4
4.0	DOCUMENT CONTROL/RECORDS MANAGEMENT	4
5.0	WORK PROCESSES	5
5.1	Equipment and Tools	5
5.2	Preparing for Fieldwork	6
5.3	Inspecting the Sampler	6
5.4	Retrieving Samples	9
5.5	Delivering Samples	10
7.0	DEFINITIONS	11
8.0	ATTACHMENTS	11
	Attachment 1- Flow Chart for Sample Retrieval	12
	Attachment 2- ISCO Sampler Inspection and Sample Retrieval Form.....	13

Inspecting Storm Water Runoff Samplers and Retrieving Samples for the MSGP	No. ENV-RCRA-QP-047.1	Page 4 of 14
	Effective Date: May 14, 2013	

1.0 PURPOSE

This procedure describes the process for inspecting ISCO storm water runoff samplers and retrieving storm water runoff samples from all locations where the Los Alamos National Laboratory (LANL) conducts storm water sampling activities for the Multi-Sector General Permit (MSGP).

2.0 SCOPE

This procedure applies to the ENV-RCRA technical staff and subcontractor personnel conducting activities at single stage stations used for monitoring under the MSGP.

2.1 HAZARD REVIEW

Hazards in the work described in this procedure are controlled through site specific [IWDs](#). The hazard level of the activities in this procedure is **moderate**.

3.0 RESPONSIBILITIES

The following personnel require training before implementing this procedure:

- ENV-RCRA technical staff and subcontract or other personnel who inspect storm water samplers and retrieve storm water samples for the MSGP.

The training method for this procedure is “self-study” (reading). For ENV-RCRA staff, this is documented in accordance with [ENV-DO-QP-115, Personnel Training](#). Other participating groups may require training documentation pursuant to local procedures.

Actions specified within this procedure, unless proceeded with “should” or “may,” are to be considered mandatory (i.e., “shall”, “will”, “must”).

3.1 PREREQUISITES

Personnel performing this procedure will be familiar with the most current versions of the following procedures and operation manuals:

- ENV-RCRA MSGP Sampling and Analysis Plan for the current monitoring year.
- Manual for Teledyne ISCO Sampler model 3700.
- Manual for Teledyne ISCO Avalanche sampler

4.0 DOCUMENT CONTROL/RECORDS MANAGEMENT

The following records are generated as a result of this procedure and are maintained in accordance with [ENV-DO-QP-110, Records Management Program](#) with the originals on file at ENV-RCRA offices:

- Completed work order for ISCO Sampler Inspection and Sample Retrieval and Collection forms (example in Attachment 2).

5.0 WORK PROCESSES

ISCO samplers are used to collect storm water runoff for Multi-Sector General Permit (MSGP) Program stations. ISCOs are designed to automatically collect water when the water surface is high enough to trigger the actuator and fill the sample bottles. Field personnel are required to inspect the sampling station while retrieving water samples and at other intervals determined by the project or as directed by work orders issued by project personnel.

A LANL Project Leader is the primary person with responsibility for the steps in this procedure. ENV-RCRA personnel will be appointed with responsibility for a subset of sampling stations.

If subsequent rain events occur before all sampler locations have been visited after the first rain event, finish the route to collect the first-event samples (safety permitting).

Inspections may be discontinued during periods or conditions that make sites dangerous for worker safety or prevent personnel from safely accessing sites (e.g., weather-related events such as flash floods, flooding, lightning, wildfires, hail, icy roads, deep snow, and LANL operations such as shots or burns at the OBOD sites).

5.1 EQUIPMENT AND TOOLS

Ensure the following equipment is available in the field vehicle:

- Copy of this procedure
- Copy of the Integrated Work Documents (IWDs)
- Charged spare battery(ies)
- Battery voltage tester
- Spare tubing (pump, suction, discharge types, sampler specific)
- Spare/replacement sample bottles (glass and poly)
- Shovel
- Wooden stakes
- Plastic wire "zip" ties
- Cell phone (only government cell phones with batteries removed are allowed in secure areas)
- Appropriate tools in tool box
- Issued Work Orders and associated forms
- Necessary access and station keys
- Coolers with ice or Blue Ice®
- Expanded Site Field Maps
- Nitrile gloves
- Paper Towels
- Marker pen (permanent, waterproof)
- Ball point pen
- Zip lock bags
- Safety glasses with side shields
- Chain of custody seals
- Sturdy hiking boots or steel toed shoes with soles that grip

5.2 PREPARING FOR FIELDWORK

Once the work orders have been approved, the following steps should be followed to prepare for fieldwork:

Step	Action
1	Receipt of a work order indicates that sampler inspections have been approved by the LANL Project Leader. Schedule work to be completed by the target date appearing on the work order(s).
2	Distribute work order(s) to field personnel. A sample Work Order form is provided in Attachment 1, ISCO Sampler Inspection and Sample Retrieval Form.
3	Inform (e.g., by e-mail) the Field Operations designee, as specified in the IWD, of the schedule for sampler inspection work and locations up to a week (preferred) before but no later than the day before (for minor changes) to be added to the appropriate plan of the day.
4	For work at sites operated by Weapons Facility Operations or Nuclear Environmental Sites, notify the appropriate access control before traveling to those sites. The IWD Part II (2101 Form) addresses specific requirements and training for these sites.
5	Obtain any necessary additional paperwork before conducting this work, including IWD's, and excavation permits (if necessary).
6	Gather the required equipment (see section above) for the work to be done.
7	Set watch(s) to the precise Mountain Standard (not daylight saving) Time. This can be done by logging on to the time page at www.time.gov (or click on the clock icon on the lab's internal home page). When at the site, the clock time on the ISCO sampler needs to be verified. Clocks must be set to Mountain Standard Time at all times, with no daylight saving time adjustment.

5.3 INSPECTING THE SAMPLER

The following table details the inspection requirements for the sampler:

Step	Action
1	If conditions prevent a sampler inspection, document the conditions on the work order and notify the Project Lead or designee within 24 hours. Multiple attempts can be documented on the original inspection work order up to the target date. After the target date, return work order to the ENV-RCRA Storm Water Data Stewards Team for reissuance (if necessary).
2	Item 1: on work order (see example in attachment 2): Enter the date and time inspection and water retrieval is performed and the name(s) and Z number(s) of the field personnel performing the work in the upper right corner of the work order.
3	Item 2: Verify and document the sampler is ON and its condition upon arrival by checking the "Yes" or "No" box. Explain any non-functional status in third column.
4	Item 3: Verify and document the ISCO programming displays by checking the "Yes" or "No" box in second column. <ul style="list-style-type: none"> For ISCO 3700 samplers = "Sampler Inhibited"

	<p>OR</p> <ul style="list-style-type: none"> For Avalanche samplers = "Program Disabled" <p>If No, repair or describe (e.g., "Done X samples", or "sampler off", etc). If more space is needed, continue notes in the "Additional Notes" section at the bottom of the page.</p>
5	Don nitrile gloves and safety glasses.
6	Remove the lid from the sampler.
7	<p>Item 4: If water was collected, check "Yes" and collect the water according to the steps in "Retrieving Storm Water Runoff Samples" below.</p> <p>Note: Complete the required MSGP Visual Assessment form to document the water appearance (foam, sheen, etc.). Ensure this form is submitted to the appropriate MSGP project personnel (see item 11).</p> <p>If No, describe (e.g., "no water collected", "sampler off") in the third column; check "No" for Item 4.</p>
8	<p>Item 5: Verify and document the sampler is set to the correct Mountain Standard Time +/- no more than 1 minute by checking the "Yes" or "No" box in the second column. If the sampler is set incorrectly, reprogram for the correct Mountain Standard Time. Describe the work performed and correction applied (e.g., "ISCO clock was X minutes slow") in the third column.</p>
9	<p>Item 6: Review the Sampling Results report and document any error messages from the sampler display by checking the "Yes" or "No" box. If a message is displayed, record the message in the "Comments" section on page 2 next to the sample bottle being filled when the problem occurred.</p> <p>If there is no indication of flow and the sampler triggered due to a non-flow event (e.g., animal, tumbleweed), indicate this in the third column.</p>
10	<p>Item 7: For the Avalanche sampler equipped with an ISCO 701 pH Module, record the pH measurement taken at the time of Bottle 1 from the Combined Results report.</p>
11	<p>Item 8: For Avalanche samplers only, and if water was collected, check "Yes" and record the refrigerator temperature (°C) upon arrival. If no water was collected, or unable to review temperature, check "No" and describe in column 3 (e.g., no sample, dead battery).</p>
12	<p>Item 9: Verify and document whether sample volumes were retrieved by checking the "Yes" or "No" box. Refer to the volume retrieval instructions on page 2 of work order.</p> <p>Record the volume retrieved in third column.</p>
13	<p>Item 10: If water was collected, perform a visual assessment of the water using the MSGP program visual assessment form (not included in this procedure). Document whether a visual assessment was performed by checking the "Yes" or "No" box.</p>
14	<p>Item 11: Verify and document sample station equipment, model, serial number, actuator height, sampler program, and bottle configuration match the header on the work order page 1 by checking the "Yes" or "No". If they do not match the data on the work order, ensure you are at the correct location. If the location is verified, check "No" and update inaccurate information.</p>
15	<p>Item 12: Verify and document power supply function. Use the voltage tester to check the voltage of the battery and record the voltage. Check "Yes" or "No" to indicate if battery voltage is acceptable (≥ 11.7 V for non-floating charged batteries at ISCO 3700 samplers and ≥ 11.0 for floating-charged batteries at Avalanche samplers as described in ENV-RCRA-QP-045).</p>
16	<p>Item 13: Verify and document the sampler passed the diagnostics test by checking the "Yes" or "No" box. Directions for running the diagnostics test is provided in ENV-RCRA-QP-045</p>

	<p>If maintenance is necessary and can be performed at the time of inspection, perform the work and describe in third column.</p> <p>If maintenance cannot be completed at the time of inspection, then describe the condition and work needed in the third column.</p>
17	<p>Item 14: Verify and document the sample tubing passed a suction test by checking the “Yes” or “No” box.</p> <p>Check the condition of sample tubing and vent tubing. If maintenance (e.g., clearing the tube, replacing the tube) is necessary and can be performed at the time of inspection, perform the work and describe in third column.</p> <p>If maintenance cannot be completed at the time of inspection, then describe the condition and work needed in third column.</p>
18	<p>Item 15: Verify all cable and electrical connections are attached and secure by checking the “Yes” or “No” box.</p> <p>If maintenance (e.g., tightening connection, replacing cables) is necessary and can be performed at the time of inspection, describe the work performed in the third column. If more space is needed, continue notes in the “Additional Notes” section.</p> <p>If maintenance cannot be completed at the time of inspection, then describe the condition and work needed in the third column.</p>
19	<p>Item 16: Verify and document sampler is ON prior to departing the site by checking the “Yes” or “No” box. If the sampler is not on, document the reason.</p>
20	<p>Item 17: If the sampler tripped and requires reset of the sampling program, reset the actuator by toggling the switch to “Reset” then back to “Latch”</p> <ul style="list-style-type: none"> • Verify and document the ISCO programming displays the following by checking the “Yes” or “No” box in column 2, page 1. • ISCO 3700 stand-alone samplers = “Sampler Inhibited” <p>OR</p> <ul style="list-style-type: none"> • Avalanche samplers = “Program Disabled” <p>If an error occurs, reconfigure the sampler (see ENV-RCRA-QP-045 for settings)</p>
21	<p>Item 18: Verify and document any maintenance completed while on site. Describe the work performed or indicate “none completed” in third column.</p> <p>Maintenance items may include (but are not limited to) battery replacement, tubing clearing or replacement, site clearing, securing electrical connections, or sampler diagnostics or repair.</p>
22	<p>Item 19: Verify and document any follow-on maintenance needed that could not be completed while on site. Describe the needed maintenance in the third column. If more space is needed, continue notes in the “Additional Notes” section. A separate work order for the station maintenance will be issued.</p> <p>If no follow-on maintenance is required, indicate “none required” in third column.</p> <p>Maintenance items may include (but are not limited to) battery replacement, tubing clearing or replacement, site clearing, securing electrical connections, or sampler diagnostics or repair.</p>
23	<p>Item 20: If no storm water samples were collected by the sampler, draw a line through page 2 of the work order, initial, and date.</p> <p>If storm water samples were collected by the sampler, skip to “Retrieving storm water runoff</p>

	samples” section.
24	Replace and secure the sampler lid and secure the sampler shelter (if sampler is in a shelter).
25	Review the completed work order(s) for accuracy and completeness and sign and date “Review by Signature” line on page 2 of work order.
26	Item 21: Review the work order(s) for accuracy and certify that the information submitted is “true, accurate, and complete” by signing and dating “Lead Signature” line on page 1.
27	Return completed original work orders to the Project Leader the same day following completion of field work. If original work orders must remain with collected samples, return photocopies of incomplete work orders to the Project Leader the same day field work is completed. Stamp or write “Copy” on the work order returned.

5.4 RETRIEVING SAMPLES

The following steps should be followed when retrieving samples:

Step	Action
1	Don nitrile gloves and safety glasses.
2	<p>See flow chart in Attachment 1.</p> <p>Item 5: Refer to the “Earliest Sample Collect Date” on work order.</p> <p>If the “Earliest Sample Collect Date” field is empty OR the ISCO sample collection date is ON or AFTER that date, samples may be retrieved per the volume requirements given on the work order. Continue with next step below.</p> <p>If the ISCO sample collection date is BEFORE the “Earliest Sample Collect Date”:</p> <ul style="list-style-type: none"> • Indicate “non-qualifying storm event” in Item 5 third column. • Discard the collected sample water on the ground. • Skip to Step 10 below.
3	Remove filled and partially-filled bottles from the carousel.
4	<p>Add up the total volume of water collected and check that the collected volume of water in glass and poly matches the required volume in the header of the work order page 2. The volume of water required to complete a sample set may vary. Retrieval of partial volume is allowed as long as the minimum specified volume is met.</p> <p>For <u>“Partial Volume Retrieval Allowed, Minimum Volume NOT Met”</u> samplers:</p> <p>If sample volume was sufficient, continue with next step 5 below.</p> <p>If sample volume was NOT sufficient:</p> <ul style="list-style-type: none"> • Record the date and time the ISCO collected water in each glass and poly bottle by the position number in the carousel in Item 21. • Record total volume retrieved as “0” in Item 22. • Pour out all water on the ground. • Skip to step 11 below. <p>For <u>“Partial Volume Retrieval Allowed, Minimum Volume Met”</u> samplers:</p> <ul style="list-style-type: none"> • Record the date and time the ISCO collected water in each glass and poly bottle by the position number in the carousel on Item 21 of page 2

	<ul style="list-style-type: none"> Record the specific ISCO displayed message for each bottle, if present, in the "Comments" column on Item 21. Record total volume retrieved in Item 22. Skip to step 11 below.
5	For samples retrieved, place lids onto the sample bottles with storm water.
6	Write the date and time collected, Station Number, and the corresponding carousel number on each retrieved sample bottle. Obtain the sample collection date and time from the ISCO sampler.
7	Item 21: Record the date and time the ISCO collected water in each glass and poly bottle by the position number in the carousel. Record the specific ISCO displayed message for each bottle, if present, in the "Comments" column.
8	Item 22: For " <u>Partial Volume Retrieval Allowed, Minimum Volume NOT Met</u> " samplers, if sample volume was NOT sufficient, record the total volume retrieved as "0" and discard sample water on ground. For " <u>Partial Volume Retrieval Allowed</u> " samplers, record the total volume retrieved.
9	Place retrieved sample bottles in a cooler with blue ice (or equivalent).
10	Return any excess water or collected volume that exceeded the amount required to the ground.
11	Install new sample bottles in the carousel for the next sampling event. The number and type of bottles may vary. Ensure bottles match the configuration specified on page 1 of the work order.
12	Item 23: Document any additional notes or site information in the "Additional Notes" section.
13	Return to steps in "Inspecting the Sampler" above.

5.5 DELIVERING SAMPLES

The following steps should be followed when delivering samples:

Step	Action
1	If samples were collected, deliver the samples, and completed, reviewed, and signed work order to the Storm Water Program Laboratory.
2	Item 25: Relinquish samples to MSGP personnel by signing "Relinquished By" or if self processed, refer to ENV-RCRA-QP-048, Processing MSGP Storm Water Samples.
3	Place samples in the refrigerators in the laboratory within the basement of TA-59-1 and lock the refrigerator to prevent tampering.

6.0 REFERENCES

None

7.0 DEFINITIONS

None

8.0 ATTACHMENTS

Attachment 1- Flow Chart for Sample Retrieval

Attachment 2- ISCO Sampler Inspection and Sample Retrieval Form

By requesting credit for this required reading I acknowledge that I have read and understand the contents of this document and I will follow and meet the requirements in this document unless it is unsafe to do so.

[Click to Acknowledge](#)

ATTACHMENT 1- FLOW CHART FOR SAMPLE RETRIEVAL

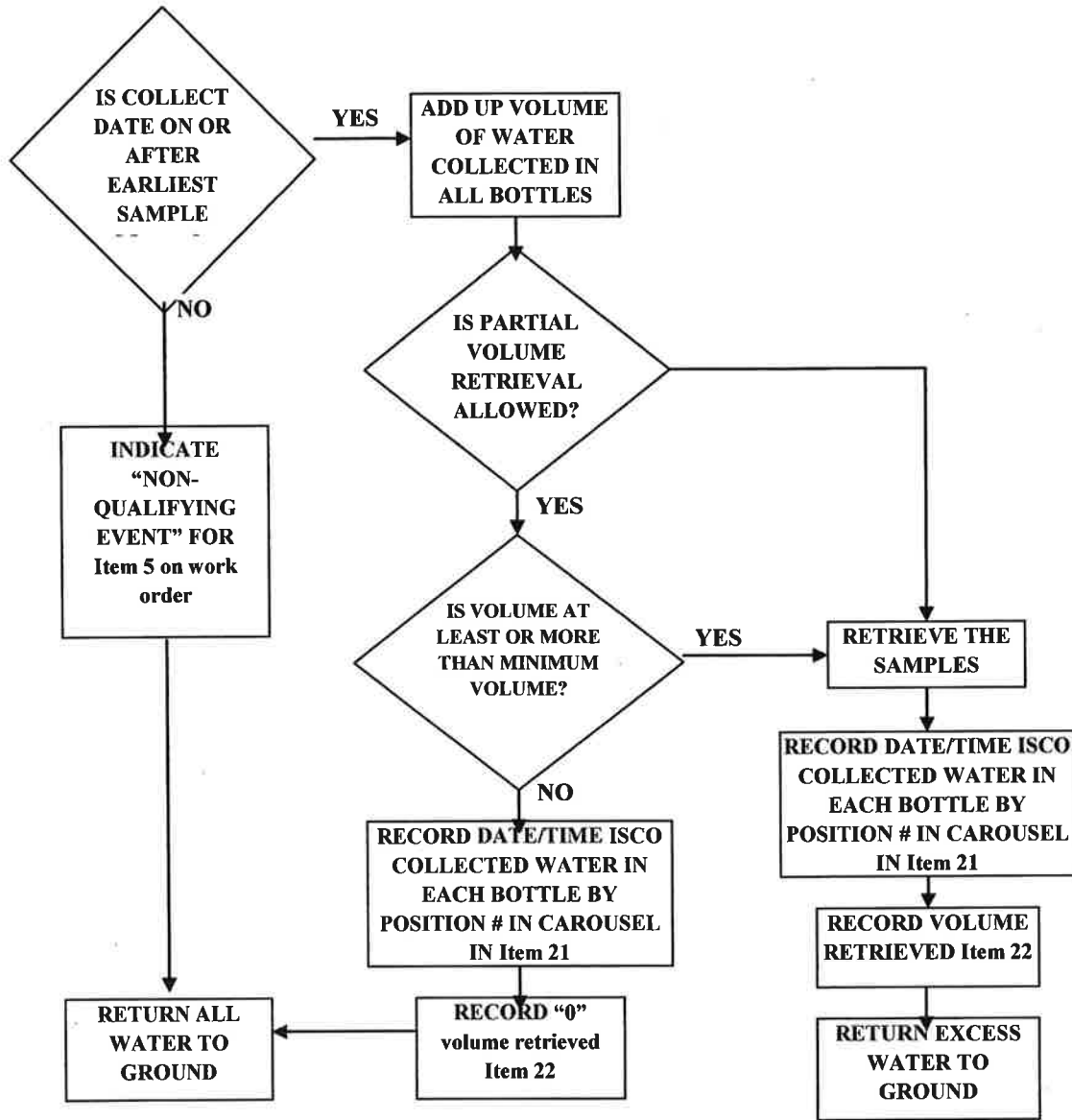

ATTACHMENT 2- ISCO SAMPLER INSPECTION AND SAMPLE RETRIEVAL FORM

ENV-QP-047.0

**LANL Multi-Sector General Permit
ISCO Sampler Inspection and Sample Retrieval Form**

Form 047-1 (3/2011)

Outfall: **3-MFS-1 : 03-0038W**

Project ID: **P-MSGP-2046**

Work Order ID: **MSGP-26090**

Target Date: **9/30/2012**

Project: **MSGP Q3 Sampler Inspection & Retrieval**

Reason: **MSGP ISCO Sampler Inspection - Sample Retrieval**

Earliest Sample Collect Date: **8/1/2012**

Date: _____ Time: _____
Name/Z#: _____
Name/Z#: _____
Lead Signature: _____

I confirm the information as recorded is true, accurate and complete.

Equipment	Manufacturer	Model	Serial No	Specification	Configuration
Actuator	ISCO	1640	210J01855	Actuator Height	2"
ISCO 3700 Sampler	Teledyne	3700	209H01264	Bottle Set	12x 1 1L Glass, 11 1L Poly
ISCO 3700 Sampler	Teledyne	3700	209H01264	Program	Storm / Multiplex 10 min delay
Pb-Acid Battery	MK Powerd	110 A-h	MSGP-110-0319-06	Voltage	> 11.7 V

ISCO Sampler Inspection Tasks

Note: If "No", provide explanation and/or correct information

ON ARRIVAL	
Is sampler ON and functioning properly upon arrival?	<input type="checkbox"/> Yes <input type="checkbox"/> No
Does ISCO display either "Sampler Inhibited" or "Program Disabled"?	<input type="checkbox"/> Yes <input type="checkbox"/> No
Is ISCO time delta < 1 min (MST)? If NO, record adjustment.	<input type="checkbox"/> Yes <input type="checkbox"/> No
Is any water collected? If YES, complete Page 2.	<input type="checkbox"/> Yes <input type="checkbox"/> No
Does the Sampling Results report indicate any error message(s)? If YES, record error message(s) in the applicable Bottle Comment field on Page 2.	<input type="checkbox"/> Yes <input type="checkbox"/> No
Is any water collected on or after the "Earliest Sample Collect Date"?	<input type="checkbox"/> Yes <input type="checkbox"/> No
Was sample volume retrieved?	<input type="checkbox"/> Yes <input type="checkbox"/> No
Was a Visual Assessment performed? If YES, complete the MSGP Visual Assessment form (ENV-RCRA-QP-064.0 Alt. 1).	<input type="checkbox"/> Yes <input type="checkbox"/> No
ON DEPARTURE	
Is the equipment information listed above, including specifications, correct?	<input type="checkbox"/> Yes <input type="checkbox"/> No
Are electrical connections secure?	<input type="checkbox"/> Yes <input type="checkbox"/> No
Record battery voltage(s). Voltage(s) > 11.7 V?	<input type="checkbox"/> Yes <input type="checkbox"/> No
Does the ISCO diagnostics test pass?	<input type="checkbox"/> Yes <input type="checkbox"/> No
Does sample tubing pass suction test?	<input type="checkbox"/> Yes <input type="checkbox"/> No
Is sampler ON upon departure?	<input type="checkbox"/> Yes <input type="checkbox"/> No
Has the actuator switch been reset to "Latch"?	<input type="checkbox"/> Yes <input type="checkbox"/> No
Does ISCO display either "Sampler Inhibited" or "Program Disabled"?	<input type="checkbox"/> Yes <input type="checkbox"/> No
If any maintenance completed during inspection, check YES and describe.	<input type="checkbox"/> Yes <input type="checkbox"/> No
If any follow-on maintenance is required, check YES and describe.	<input type="checkbox"/> Yes <input type="checkbox"/> No

ENV-QP-047.0

**LANL Multi-Sector General Permit
ISCO Sampler Inspection and Sample Retrieval Form**

Form 047-1 (3/2011)

Outfall **3-MFS-1 : 03-0038W**

Project ID **P-MSGP-2046**

Work Order ID **MSGP-26090**

Complete if sample bottles contain water OR to to record ISCO message

Sample Volume Requirements

Bottle Type: Poly or Glass bottles

Minimum Volume (L): 0.5

Maximum Volume (L): 1

Botle #	Bottle Type	Date	Time (MST)	Comments
1	<input type="checkbox"/> P <input type="checkbox"/> G	/ / 2012		
2	<input type="checkbox"/> P <input type="checkbox"/> G	/ / 2012		
3	<input type="checkbox"/> P <input type="checkbox"/> G	/ / 2012		
4	<input type="checkbox"/> P <input type="checkbox"/> G	/ / 2012		
5	<input type="checkbox"/> P <input type="checkbox"/> G	/ / 2012		
6	<input type="checkbox"/> P <input type="checkbox"/> G	/ / 2012		
7	<input type="checkbox"/> P <input type="checkbox"/> G	/ / 2012		
8	<input type="checkbox"/> P <input type="checkbox"/> G	/ / 2012		
9	<input type="checkbox"/> P <input type="checkbox"/> G	/ / 2012		
10	<input type="checkbox"/> P <input type="checkbox"/> G	/ / 2012		
11	<input type="checkbox"/> P <input type="checkbox"/> G	/ / 2012		
12	<input type="checkbox"/> P <input type="checkbox"/> G	/ / 2012		
13	<input type="checkbox"/> P <input type="checkbox"/> G	/ / 2012		
14	<input type="checkbox"/> P <input type="checkbox"/> G	/ / 2012		

Total Volume Retrieved (liters): Poly Glass

Relinquished by Signature	Date	Time	Received by Signature	Date	Time

Additional Notes:

LANL PERSONNEL USE ONLY (Initials and dates)		
Accepted	Tech QC	ENV-RCRA Review

ENV-CP-QAPP-MSGP, R5



Effective Date: 11/04/2013

Next Review Date: 11/04/2015

Environment, Safety, Health Directorate

Environmental Protection Division – Compliance Programs Group

Quality Assurance Project Plan

**Stormwater Multi-Sector General Permit for
Industrial Activities Program**

Reviewers:

Name:	Organization:	Signature:	Date:
Melanie Lamb	ADESH-OIO, QA Specialist	Signature on File	

Derivative Classifier: Unclassified DUSA ENVPRO

Name:	Organization:	Signature:	Date:
Ellena Martinez	ADESH-OIO	Signature on File	

Approval Signatures:

Subject Matter Expert: Holly Wheeler	Organization: ENV-CP	Signature: Signature on File	Date:
Responsible Line Manager: Mike Saladen	Organization: ENV-CP, Team Lead	Signature: Signature on File	Date:
Responsible Line Manager: Anthony Grieggs	Organization: ENV-CP, Group Leader	Signature: Signature on File	Date:

CONTROLLED DOCUMENT

This copy is uncontrolled. The controlled copy can be found on the ENV Division Web page.

Users are responsible for ensuring they work to the latest approved version.

History of Revisions

Document Number <i>[Include revision number, beginning with Revision 0]</i>	Effective Date <i>[Document Control Coordinator inserts effective date]</i>	Description of Changes <i>[List specific changes made since the previous revision]</i>
0	06/03	New Document
1	12/05	Annual review and revision
2	07/07	Annual review, incorporated organizational restructure changes.
3	07/09	Biennial Review and Revision
4	07/09	Biennial Review and Revision
5	10/13	Biennial Review and Revision. New format implemented.

Table of Contents

1.0 QUALITY PROGRAM.....5

 1.1 Quality Program Purpose5

 1.2 Organization5

 1.3 Responsibilities6

2.0 PERSONNEL DEVELOPMENT6

 2.1 MSGP Curricula.....6

 2.2 MSGP Inspector Qualifications8

 2.3 MSGP SWPPP Preparer Qualifications8

 2.4 MSGP Visual Assessor Qualifications9

 2.5 Training Responsibilities9

3.0 QUALITY IMPROVEMENT.....10

 3.1 Corrective Actions within ENV-RCRA.....10

 3.3 Quality Improvement Responsibilities.....10

4.0 DOCUMENT CONTROL/RECORDS MANAGEMENT10

 4.1 Program Records11

 4.2 Program Records Responsibilities11

 4.3 Electronic Media12

 4.4 Databases.....12

 4.4 Implementation Responsibilities.....13

5.0 PLANNING AND PERFORMING WORK.....13

 5.1 Work Processes14

 5.3 Work Performance14

 5.4 StormWater Pollution Prevention Plan14

 5.5 Inspections16

 5.6 StormWater Monitoring.....16

 5.7 Discharge Monitoring Reports.....19

 5.8 Adverse Weather Conditions and Climates with Irregular Stormwater Runoff.....20

 5.9 Reporting and Recordkeeping.....21

 5.10 Best Management Practices22

 5.11 Information Management.....22

 5.12 Responding to Water Quality Exceedances22

 5.13 Instrumentation and Equipment24

6.0 DESIGN24

7.0 PROCUREMENT25

8.0 INSPECTION AND ACCEPTANCE TESTING.....26

9.0 MANAGEMENT ASSESSMENT26

10.0 INDEPENDENT ASSESSMENT27

11.0 ATTACHMENTS27

Stormwater MSGP for Industrial Activities Program	No. ENV-CP-QAPP-MSGP, R5	Page 4 of 40
Effective Date: 11/04/2013		

Attachment 1- MSGP Program Organization28

Attachment 2 – Annual Reporting Form.....29

Attachment 3 – Routine Inspection Form35

Attachment 4 -- MSGP Facilities and Storm Water Monitored Outfalls Associated with Industrial Activity 2011, Permit NMR05GB2137

Attachment 5 – Pollutants Under Impaired Waters Monitoring38

Attachment 6 – Analytes by Industrial Sector39

Attachment 7 – References and Guidance Documents40

1.0 QUALITY PROGRAM

LANL will comply with the monitoring requirements as specified by the 2008 National Pollutant Discharge Elimination System (NPDES) Stormwater Multi-Sector General Permit for Industrial Activities. Compliance will be demonstrated through the successful implementation of this project plan and applicable procedures.

Los Alamos National Laboratory (the Laboratory) has established a comprehensive stormwater program for its industrial activities. Historically, the Laboratory operated under the NPDES Baseline General Permit and then under the NPDES 1995, 2000, and 2008 Multi-Sector General Permits. The Laboratory submitted its NOI for 2008 coverage in December 2008.

The 2008 MSGP was issued on September 22, 2008 and became effective on September 29, 2008.

The purpose of this project plan is to ensure compliance with the following:

- 2008 NPDES Multi-Sector General Permit (MSGP) and the Clean Water Act (CWA)
- DOE Order 450.1, *Environmental Protection Program*, and DOE Order 5400.5, *Radiation Protection of the Public and Environment*, which establish environmental protection program policies, requirements, and responsibilities

The Environmental Protection, Environmental Compliance Programs (ENV-CP) Water Quality Team has been tasked with overseeing institutional stormwater compliance related activities at the Laboratory.

1.1 QUALITY PROGRAM PURPOSE

This Quality Assurance Project Plan (QAPP) describes the policies and requirements that ensure MSGP activities are conducted in a consistent, agreed-upon manner.

This QA Project Plan describes the policies and requirements that ensure the MSGP processes are conducted in a consistent, agreed-upon manner. Drivers for the quality plan include:

- DOE Order 414.1C, *Quality Assurance*
- SD330, *LANL Quality Assurance Program*

This QA Project Plan (QAPP), including implementing procedures, is a sub-tier document to the SD330, *LANL Quality Assurance Program*. The following documents provide requirements to ensure that the MSGP Program is operated in accordance with established plans and procedures:

- SD330, *LANL Quality Assurance Program*
- QA Project Plan for the MSGP (this document)
- Implementing procedures

1.2 ORGANIZATION

ENV-CP is responsible for compliance oversight of the Laboratory's MSGP coverage. The Group is organized by teams under the line management direction of the Group Leader. Teams are cross-functional and focus on specific Laboratory water quality responsibilities, deliverables, or

products. Teams are guided by Team Leaders who have the responsibility to assure the program is completed and properly implemented.

The Team Leader coordinates the project and reports to the ENV-CP Group Leader. The Project Lead implements program oversight, coordinates contractor efforts (if there are any), and reports to the Team Leader. A QA Specialist is assigned to work for the Team Leader to provide quality assurance assistance, advice, and review. In addition, representatives from other groups may participate and contribute to this team as subject matter experts for project activities. The project organization is shown in Attachment 1.

Applicable regulatory drivers include the following:

- Clean Water Act (CWA)
- 2008 NPDES Multi-Sector General Permit (MSGP)
- DOE Order 450.1, *Environmental Protection Program*
- DOE Order 5400.5, *Radiation Protection of Public and Environment*
- [P401, Procedure to Identify, Communicate, and Implement Environmental Requirements](#)

1.3 RESPONSIBILITIES

The following table lists specific responsibilities:

Who	What
Group Leader	Assure that qualified staff complies with regulatory requirements associated with the MSGP.
Project Lead	Ensure that MSGP-related activities are performed in accordance with the requirements specified in this plan.
ENV-CP Staff	Perform MSGP-related activities as assigned by the Team Leader or Project Leader

2.0 PERSONNEL DEVELOPMENT

Qualified team members will be hired and trained as prescribed in [ENV-DO-QP-115, Personnel Training](#). Minimum training requirements for ENV personnel are described in the ENV Division Qualification Standards. The LANL Human Resources Division maintains documentation of education qualification. Required MSGP qualifications and training plans are listed below.

2.1 MSGP CURRICULA

The MSGP Program requires personnel with the following training requirements:

MSGP Inspectors

Curricula 10697 ENV-RCRA MSGP Inspector

Item 43337 ENV-CP-QAPP-MSGP

Item 54892 ENV-RCRA-QP-022 MSGP Stormwater Corrective Actions

Item 42415 ENV-DO-QP-101 *Environmental Reporting Requirements for Releases or Events*
Item 42547 ENV-DO-QP-111 *Reporting Environmental Releases to Pueblo Governments*
Item 40708 ENV-DO-QP-108 *Preparation of External Correspondence for Review and Approval*
Item 43172 ENV-DO-QP-112 *Coordinating Regulatory Inspections*
Item 42891 ENV-DO-QP-113 *Tracking Issues and Actions*
Item 43805 ENV-DO-QP-114 *Logbook Use and Control*
Item 45777 ENV-DO-QP-100 *General Field Safety*

Curricula 131 Field Worker Training Requirements

Item 43562 or 3583 or 16585 CPR/AED: LANL Workplace
Item 3574 or 13264 First Aid

MSGP SWPPP Preparers

Curricula 7814 ENV-RCRA MSGP SWPPP Preparer

Item 43337 ENV-CP-QAPP-MSGP
Item 56593 ENV-RCRA-QP-044 *Preparing Storm Water Discharge Monitoring Reports (MDMRs) for the NPDES Multi-Sector General Permit*
Item 40708 ENV-DO-QP-108 *External Correspondence*
Item 43172 ENV-DO-QP-112 *Coordinating Regulatory Inspections*
Item 42891 ENV-DO-QP-113 *Tracking Issues and Actions*
Item 43805 ENV-DO-QP-114 *Logbook Use and Control*
Item 45777 ENV-DO-QP-100 *General Field Safety*

Curricula 51 ENV-RCRA Design Engineer

Item 44269, COE Review of LANL Produced Design Documents, AP-341-620
Item 44266, COE System Design Descriptions, AP-341-61
Item 44263, COE Engineering Drawings and Sketches, AP-341-608
Item 44261, COE Calculation, AP-341-605
Item 44258, COE Requirements and Criteria Document, AP-341-602
Item 44257, COE Functions & Requirements Document, AP-341-601
Item 43658, CORE Engineering Overview
Item 55428, COE Management Level Determination, AP-341-502
Item 54168, P342 Engineering Standards
Item 47029, COE LANL Review of Design by External Agencies, AP-341-622
Item 43666, Engineering Design Management
Item 43663, Engineering Technical Baseline
Item 44225, COE Evaluation of Vendor Information, AP-341-701

MSGP Visual Assessors

Curricula 10698 ENV-RCRA MSGP Visual Assessor

Item 43337 ENV-RCRA-QAPP-MSGP
Item 50493 ENV-RCRA-QP-064 *MSGP Storm Water Visual Assessments*
Item 42415 ENV-DO-QP-101 *Environmental Reporting Requirements for Releases or Events*
Item 42547 ENV-DO-QP-111 *Reporting Environmental Releases to Pueblo Governments.*
Item 40708 ENV-DO-QP-108 *External Correspondence*

Stormwater MSGP for Industrial Activities Program	No. ENV-CP-QAPP-MSGP, R5	Page 8 of 40
Effective Date: 11/04/2013		

- Item 43172 ENV-DO-QP-112 *Coordinating Regulatory Inspections*
- Item 42891 ENV-DO-QP-113 *Tracking Issues and Actions*
- Item 43805 ENV-DO-QP-114 *Logbook Use and Control*
- Item 45777 ENV-DO-QP-100 *General Field Safety*

- Curricula 131 Field Worker Training Requirements
- Item 43562 or 3583 or 16585 CPR/AED: LANL Workplace
 - Item 3574 or 13264 First Aid

2.2 MSGP INSPECTOR QUALIFICATIONS

Inspections:

- Post high school education or experience in engineering or environmental science or a related field; or industrial site field experience involving stormwater pollution prevention.
- 2 years experience of completing MSGP inspections or 1 year MSGP inspection experience with the Certified Inspector of Sediment and Erosion Control (CISEC) certification.
- 6 months knowledge of LANL facility operations.
- Demonstrated ability, as determined by the Multi-Sector General Permit Project Lead and/or Water Quality Team Leader, to successfully and effectively evaluate and identify the following at industrial sites:
 - Conditions and activities that could impact stormwater quality at the facility.
 - Inadequate or ineffective BMPs.
 - Required modification or maintenance of existing BMPs.
 - Locations requiring new or additional BMPs.
 - Potential pollutant sources associated with the facility.
 - Appropriate and correct site stabilization measures.
- Demonstrated ability, as determined by the Multi-Sector General Permit Project Lead and/or Water Quality Team Leader, to evaluate the compliance status of each industrial facility and document identified issues during an inspection.
- Demonstrated ability, as determined by the Multi-Sector General Permit Project Lead and/or Water Quality Team Leader, to properly and effectively complete inspection reports, including the ability to perform the following:
 - Prepare reports in a clear, concise manner, identifying site conditions and issues.
 - Write legibly and describe conditions clearly and accurately.
 - Use proper spelling and grammar.
 - Complete the MSGP Routine Inspection Report forms accurately.
 - Accurately enter findings into the Corrective Actions Report database.
- Conduct inspections in a professional manner.
- Be a member of, or contractor supporting, ENV-RCRA or ENV Division.

2.3 MSGP SWPPP PREPARER QUALIFICATIONS

SWPPP Preparation:

One of the 2 criteria below must be satisfied:

- BS degree or experience in engineering, environmental science, or related field, with a background involving stormwater pollution prevention and regulatory compliance relating to MSGP sites and a 1 year minimum of LANL facility operations knowledge and 1 year experience of completing MSGP inspections; or
- Certified Professional in Erosion and Sediment Control (CPESC) or Professional Engineer (PE) with a demonstrated background in stormwater management, sediment and erosion control, and regulatory compliance.

In addition to:

- Demonstrated ability, as determined by the Multi-Sector General Permit Project Lead and/or Water Quality Team Leader, to:
 - Prepare SWPPPs per LANL format and in compliance with NPDES MSGP requirements.
 - Identify and specify appropriate BMPs and stabilization measures.
 - Identify potential pollutant sources associated with the facility.
 - Perform necessary calculations to meet regulatory requirements.
 - Prepare a site map.
 - Be a member of, or contractor supporting, ENV-CP or ENV Division.

5.4 MSGP VISUAL ASSESSOR QUALIFICATIONS

Quarterly Visual Assessments:

- Education or experience in engineering, environmental science, or a related field; or industrial site field experience involving stormwater pollution prevention; and
- Completed ENV-RCRA training on how to collect and evaluate visual assessment; and
- Demonstrated ability, as determined by the Multi-Sector General Permit Program Lead and/or Water Quality Team Leader, to:
 - Collect quarterly visual samples at the designated outfall.
 - Complete the applicable portions of the MSGP Quarterly Visual Assessment Form.
 - Have working knowledge of the regulatory requirements in Section 4.2 of the MSGP.

5.5 TRAINING RESPONSIBILITIES

All personnel performing MSGP project-related work are required to obtain appropriate training prior to performing work governed by a procedure. Training for all project personnel will be performed and documented in accordance with ENV-DO-QP-115, *Personnel Training*.

The following table lists specific responsibilities regarding training requirements.

Who	What
Group Leader	Ensure project personnel meet all Laboratory training requirements.
Program Lead	Establish and document job descriptions for each position within the MSGP Project. Ensure all project personnel have the appropriate level of education,

	experience, and training.
--	---------------------------

3.0 QUALITY IMPROVEMENT

The MSGP Project subscribes to the principles of problem prevention and continuous improvement. The Project Lead is committed to evaluating improvement opportunities identified by trending and reporting.

The Project Lead provides verbal and written updates, as needed, to the Team Leader and Group Leader to keep group management apprised of the focus of the MSGP Project activities and to address any shortcomings that may be identified.

3.1 CORRECTIVE ACTIONS WITHIN ENV-RCRA

Corrective actions for all ENV-RCRA programs and projects are initiated, tracked, corrected, and documented according to *P330-6 Nonconformance Reporting*, *P322-4 Laboratory Performance Feedback and Improvement Process*, *SD330, Los Alamos National Laboratory Quality Assurance Program*, and Division/Group procedures.

3.3 QUALITY IMPROVEMENT RESPONSIBILITIES

The following table lists specific responsibilities for quality improvement:

Who	What
Project Lead	Monitor program performance and ensure issues are corrected in a timely manner.
ENV-CP Staff	Identify opportunities for process improvement, health and safety enhancement, environmental protection, or other improvements of the program's operations. Discuss the identified opportunities with the Project Lead. Ensure issues are reported and corrected in a timely manner.

4.0 DOCUMENT CONTROL/RECORDS MANAGEMENT

The program lead, at least one reviewer, and the Group Leader will approve all revisions to this plan. Revisions to the plan will be provided to the QA Specialist. This plan will be reviewed and revised (if necessary) biennially.

This document will be controlled under the organization's document control system (ENV-DO-QP-106, *Document Control*). Controlled copies of ENV documents are located on the Internet: <http://int.lanl.gov/orgs/env/rcra/qa.shtml>, all other copies are uncontrolled.

Procedures will be developed as necessary and in accordance with ENV-DO-QP-105, *Preparation, Review, and Approval of Procedures*.

Phone calls, email, or fax communications will be documented and controlled if the content provides direction or results in decisions.

4.1 PROGRAM RECORDS

The number, type, and detail of all records to be kept will provide sufficient information to allow an individual with equivalent education and training to verify or reconstruct the results. Implementing procedures specify the records, forms, logbook entries, or other information to be kept as documentation of the performance of the procedure.

Records to be kept in the ENV-CP records system include the following:

- Copy of the Multi-Sector General Permit
- Annual Site Compliance Evaluation reports
- Corrective Action Reports
- Reports and certifications required by MSGP
- Records of all data used to complete MSGP Notice of Intent
- Discharge Monitoring Reports

Records to be kept by the Deployed Environmental Professional assigned to the FOD in which the industrial facility resides includes the following:

- Copies of Stormwater Pollution Prevention Plans
- Reports and certifications required by MSGP
- Routine Inspection Forms
- Supporting analytical data reports including Visual Assessment Forms
- Corrective Action Reports
- Discharge Monitoring Reports
 - Annual Site Compliance Evaluation reports

All ENV-CP records will be maintained and available (after the deadline for submittal as given in applicable procedures) for auditing in the records center at ENV-CP (ENV-DO-QP-110, *Records Management*). Records will be archived in compliance with Laboratory and DOE requirements for records retention, storage, and management.

4.2 PROGRAM RECORDS RESPONSIBILITIES

The following table lists specific responsibilities for program records management:

Who	What
Team Leader	Ensure QAPP meets minimum specifications for documentation and records of the SD330, <i>Los Alamos National Laboratory Quality Assurance Program</i>
Program Lead	Conduct annual review of records to ensure compliance with project requirements.

4.3 ELECTRONIC MEDIA

The project will utilize electronic means as necessary to maintain data and perform calculations on these data. Electronic means will not however replace paper copies. All records that must be maintained to meet the requirements of the Permit will be kept in hard copy as the official record.

4.4 DATABASES

Analytical data will be maintained in the LANL Water Quality Database (WQDB). Security, verification, and validation of data are maintained in accordance with LANL procedures.

Security -- ENV data will be maintained electronically in a secure manner and will be protected from loss by being maintained as part of an official dataset that is backed up at least weekly.

Verification of data -- All ENV data, either electronic or hardcopy must undergo a verification and validation process that includes the following:

Verification

- Paper deliverables match electronic data that are stored in an official dataset. Paper deliverables include:
 - chain of custody for sample data
 - field log, if applicable, for sample data
 - data packages for analytical data
 - documentation packages for supporting data (e.g., geographic information system)
- All hand-entered data have been verified by a person other than the individual performing the entry
- Electronic uploads of data (e.g., electronic data deliverables) have been spot checked (at least 10%) to ensure the upload performed as expected
- Hard copy supporting information (e.g., data packages, chains of custody, validation reports, etc.) is evaluated for completeness, archived, and available for audit

Validation --analytical data validation is the responsibility of the EP Directorate. The process will include the following:

- Validate that sample and quality assurance/quality control data and information meet contract specifications
- Assign validation flags, as appropriate
- Identify the analytical supplier
- Identify the analytical method

Verification of calculations -- A person other than the person who generated the query will review for accuracy all compliance related calculations performed in a database through queries. This review will be documented and forwarded to the appropriate record series.

Spreadsheets:

Backups -- All spreadsheets used to hold data and generate reports to be used in demonstrating compliance will be maintained in a secure location. The preferred location is on the Group server. Spreadsheets will be backed up at least weekly.

Verification of data -- All compliance-related data uploaded into a spreadsheet will be verified to be accurate against the original paper copy. Data that are uploaded through electronic means will undergo a 10% verification. Data that are uploaded through manual means will undergo a 100% verification. Someone other than the data entry person must perform the 100% review. This review will be documented and forwarded to the appropriate record series.

Verification of calculations -- A person other than the person who generated the spreadsheet will review for accuracy all compliance-related calculations performed in a spreadsheet. This review will be documented and forwarded to the appropriate record series. Modifications to the function of these spreadsheets will also be verified in this manner.

Software control -- The integrity of spreadsheets will be ensured by limiting access to these spreadsheets to only trained, authorized personnel. Additionally, at least once per year, the function of the spreadsheets will be verified by hand calculations. Documentation of this review will be forwarded to the appropriate record series.

4.4 IMPLEMENTATION RESPONSIBILITIES

The following table lists specific responsibilities:

Who	What
Program Lead	Regularly assess data integrity methods used by MSGP personnel.

5.0 PLANNING AND PERFORMING WORK

Work conducted under this program ensures compliance with the 2008 Multi-Sector General Permit; the Clean Water Act; and DOE Orders 450.1, *Environmental Protection Program*, and 5400.5, *Radiation Protection of the Public and Environment*.

Work that contributes to achieving the quality specifications of the MSGP deliverables will be planned and documented as described in this document and implementing procedures.

Work will be performed according to applicable plans and implementing procedures. The team leader will provide first line supervision of personnel assigned to project tasks to ensure work is performed to achieve project quality specifications. Before changing a work process that affects the project quality specifications, the team leader will ensure the same level of planning and review as used in the initial project planning steps.

Stormwater MSGP for Industrial Activities Program	No. ENV-CP-QAPP-MSGP, R5	Page 14 of 40
Effective Date: 11/04/2013		

5.1 WORK PROCESSES

All work should be regarded as a process. Each process consists of a series of actions and is planned and carried out by qualified workers using specified work processes and equipment under administrative, technical, and environmental controls established by management to achieve an end result. Workers are the best resource of contributing ideas for improving work processes and will be involved in work process design, process evaluation, and providing the feedback necessary for improvement.

All work is planned and performed using the principles of Integrated Safety Management and in compliance with P300, *Integrated Work Management for Work Activities*.

5.3 WORK PERFORMANCE

Management should ensure that the following are clearly identified and conveyed to workers prior to beginning work:

- customer and data requirements for the work and final product;
- acceptance criteria applicable to work and final product;
- hazards associated with the work;
- technical standards applicable to work and final product; and
- safety, administrative, technical, and environmental controls to be employed during the work.

The work processes used to meet the regulatory requirements and the requirements of this plan can be divided as follows:

- Stormwater Pollution Prevention Plans (Multi-Sector General Permit Section 5.0)
- Inspections (Multi-Sector General Permit Section 4.0)
- Monitoring (Multi-Sector General Permit Section 6.0)
- Discharge Monitoring Reports (Multi-Sector General Permit Section 7.1 – Reporting Monitoring Data to EPA)
- Best Management Practices (Multi-Sector General Permit Section 2.0 –Control Measures)
 - Reporting and Recordkeeping (Multi-Sector General Permit Section 7.0)

5.4 STORMWATER POLLUTION PREVENTION PLAN

Stormwater Pollution Prevention Plan (SWPPP) development and implementation by the regulated industrial facility is required for MSGP compliance (refer to Section 8.0 of the 2008 MSGP for *Sector-Specific Requirements for Industrial Activity* and Appendix D, *Sectors of Industrial Activity Covered by This Permit*). The SWPPP is intended to document the selection, design, and installation of control measures. Additional documentation requirements are intended to document the implementation (including inspection, maintenance, monitoring, and corrective

action) requirements identified in the 2008 MSGP permit. The SWPPP is a written assessment of potential sources of pollutants in stormwater runoff and control measures that will be implemented at the specific industrial facility to minimize the discharge of pollutants in runoff from the site. These control measures include site-specific Best Management Practices (BMPs), inspections, employee training, and reporting. The procedures detailed in the SWPPP must be implemented by the facility and updated as necessary, with a copy of the SWPPP kept on-site.

The SWPPP development process involves evaluating regulated industrial activities and requiring Facility Management support in implementation, improvement, and revision of the Plans.

5.4.1 DISCHARGE MONITORING REPORTS

The Laboratory is required to submit analytical results of stormwater monitoring and to keep the results with the facility specific SWPPP. The Laboratory must certify and submit analytical monitoring results obtained from each facility specific sampling location (i.e., the sampling station located at the monitored outfalls) associated with industrial activity on a Discharge Monitoring Report (DMR) form or use it to report any of the following:

- no discharge for all outfalls for a specific monitoring period;
- the industrial facility status has changed to inactive and unstaffed;
- the facility status has changed to active; or
- no further pollutant reductions are achievable for all outfalls and for all pollutants (see Section 6.2.1.2 of the 2008 MSGP).

5.4.2 ANNUAL SITE COMPLIANCE EVALUATION REPORT

The Laboratory is required to submit an annual report (Attachment 2) to the Environmental Protection Agency (EPA) that includes the findings from the comprehensive site inspection and any corrective action documentation. The documentation must include the following:

- identification of the condition triggering the need for corrective action review;
- date and description of the problem identified;
- summary of the corrective action taken or to be taken;
- notice of whether SWPPP modifications are required as a result of the discovery or corrective action;
- date corrective action was initiated; and
- date corrective action was completed or is expected to be completed.

The following table lists responsibilities:

Who	What
Project Lead	Ensure that SWPPP requirements are performed in accordance with the MSGP.

Facility Management Support	Implement SWPPP requirements as recommended by the Project Lead.
ENV-CP Staff and Deployed Environmental Professionals (DEPs)	Assure SWPPP implementation as required by MSGP.
DEPs	Develop, modify, and update SWPPPs and assist facility personnel with SWPPP implementation.

5.5 INSPECTIONS

The MSGP requires periodic inspection of industrial processes and maintenance of (BMPs) to assure effectiveness of control measures. The Laboratory has implemented a quarterly or monthly inspection process (depending on the industrial facility) to support this determination. A copy of the Routine Inspection Form is provided in Attachment 3.

5.6 STORMWATER MONITORING

Benchmark stormwater monitoring is the required mechanism for determining the effectiveness of corrective actions and meeting the requirements of the MSGP. Refer to Attachment 4, *MSGP Facilities and Stormwater Monitored Outfalls Associated with Industrial Activity 2011*, for a list of Laboratory sites that have monitoring requirements. Laboratory management has made an investment in time and materials, in addition to a commitment to comply with the 2008 MSGP Permit. All stormwater monitoring is conducted by ENV-CRP personnel. The MSGP Project currently has a network of 23 monitoring stations. Considerations to be used for MSGP stormwater monitoring development decisions will include MSGP requirements, new state water quality standards, Administrative Authority requests, or new permit requirements. Stormwater monitoring will be conducted as specified in the MSGP.

Effluent Limitations stormwater monitoring is required for the following type of facility of LANL:

Regulated Activity	Parameter	Effluent Limit	Monitoring Frequency	Sample Type
Discharges from asphalt emulsion facilities	Total Suspended Solids	23.0 mg/L daily max. 15.0 mg/L, 30-day avg.	1/year	grab
	pH	6.0-9.0 s.u.	1/year	grab
	Oil and Grease	10.0 mg/L 30-day avg.	1/year	grab

Stormwater MSGP for Industrial Activities Program	No. ENV-CP-QAPP-MSGP, R5	Page 17 of 40
	Effective Date: 11/04/2013	

This determination was made in accordance with Section 1.1.2.4 of the MSGP. The TA-60 Asphalt Batch Plant meets the criteria for effluent limitations monitoring in this section. Exceedances of the effluent limits in this table require immediate action. In addition, if follow-up monitoring after corrective actions also exceeds an effluent limit guideline, an Exceedance Report for Numeric Effluent Limits must be submitted to EPA no later than 30 days after lab results have been received and verified.

Impaired Waters stormwater monitoring is required for discharges made to an impaired water. The canyons within and surrounding Los Alamos National Laboratory are declared as Impaired Waters by the New Mexico Environment Department. The pollutants vary from canyon to canyon and are listed in Attachment 5, *Pollutants Under Impaired Waters Monitoring*. The pollutants may be discontinued in subsequent annual monitoring if the concentration is below background levels in stormwater or if the constituent is not detected.

Visual assessments are also required by the MSGP and are an important tool for collecting information to determine the effectiveness of controls in preventing potential contaminants from migrating off Laboratory property. Accordingly, field personnel must conduct visual assessments for stormwater collected at the monitoring stations or discharged through substantially identical outfalls associated with industrial facilities located throughout the Laboratory. Information recorded will document all observations that are required by the MSGP (see [ENV-RCRA-QP-064, Multi-Sector General Permit Storm Water Visual Inspections](#)).

The Laboratory's MSGP permit requires stormwater quality monitoring to evaluate compliance with water quality standards and evaluation against benchmarks. Parameters sampled at the monitoring stations are selected based on permit requirements and the results of the previous year.

Four stormwater samples per year are required under the 2008 MSGP, but it is not necessary to collect them in consecutive quarters if climatic conditions that prevented quarterly collection are documented (see *Adverse Weather Conditions* in Section 6.1.5 of the MSGP). Sample locations are listed in Attachment 4, *MSGP Facilities and Stormwater Monitored Outfalls Associated with Industrial Activity 2011*, and collection will be conducted in accordance with LANL and NPDES Permit requirements and the current year MSGP Sampling and Analysis Plan.

Stormwater samples are used to demonstrate compliance with water quality standards and requirements to evaluate results against benchmark parameters (Attachments 5 and 6). Any persons involved in the preparation, retrieval, and analysis must maintain positive control of samples at all times until sample disposal. ENV-RCRA personnel will follow guidance in the Associate Directorate for Environmental Programs (ADEP) document [ENV-WQH-QP-029, Creating and Maintaining a Chain of Custody](#), as well as, [ENV-RCRA-QP-047, Inspecting Storm Water Runoff Samplers and Retrieving Samples](#), and [ENV-RCRA-QP-048, Processing MSGP Storm Water Samples](#).

Chain of custody is maintained during:

Activity	Responsibility
Sample collection and preparation	All persons (other than analytical personnel) performing sample preparation and collection will be trained to sample collection procedures and must adhere to the chain of custody requirements therein.
Analysis	Analytical laboratories performing sample analysis will maintain sufficient procedures to ensure positive control of samples as specified in the existing Statement of Work.
Storage/ disposal	Analytical laboratories will maintain retained samples and/or sample portions under chain of custody until reanalysis, or ultimate disposal.

The LANL Sample Management Office (SMO) will be the central point for all analytical laboratory selection, evaluations, sample submittal, and data return. The SMO will evaluate potential analytical laboratories, prepare analytical statements of work that include requirements, and arrange contracts with selected laboratories for analysis of all samples. The SMO will accept samples from field collection personnel, process the sample, ship the samples to the off-site analytical laboratories, and receive the data packages from the laboratories.

All analytical data will be received from analytical laboratories in electronic format and uploaded into a database. All received data will be checked for completeness and adherence to contract requirements. After uploading, all data will undergo verification and validation (V&V) for evidence of laboratory contamination, improper analytical method, and other analytical issues which could potentially affect data quality.

Field data collected by sample collection personnel will be verified and validated by the SMO when field personnel deliver samples to the SMO.

If significant V&V issues are identified, results will be forwarded to and discussed with the responsible project leads.

Data issues that result from procedural failures, personnel errors, or other failures to follow requirements will be documented as issues and corrected according to ENV-DO-QP-113, *Tracking Issues and Actions*.

The following table lists responsibilities:

Who	What
Project Lead	Ensure that all project monitoring requirements are performed in accordance with the MSGP. Review and update the MSGP Sampling and Analysis Plan annually.

	When complete, communicate findings to the team members for implementation. Make appropriate arrangements with the SMO to accept, process, and submit samples to an analytical laboratory for required analyses as specified in the SAP.
MSGP Water Quality Compliance Personnel	<ul style="list-style-type: none"> • Implement monitoring program as required by the MSGP Project Lead. • Conduct stormwater sampling in accordance with the MSGP Sampling and Analysis Plan and applicable procedures. • Ensure procedures for sample handling and control during sample preparation and retrieval are followed.
Sample Management Office	<ul style="list-style-type: none"> • Develop Statements of Work (SOW) for all analytical laboratories that perform analytical work for the MSGP project in accordance with P840-1, <i>Procurement Quality</i>. • Ensure analytical laboratories comply with the DOE's SOW. Conduct an annual audit of the laboratory to ensure compliance with the SOW. • Approve Statements of Work for analytical laboratories that are contracted to analyze water samples. • Approve analytical laboratories that are contracted to analyze water samples for regulatory compliance purposes. • Accept samples and submit them to and approved analytical laboratory for analysis. • Track progress of samples at the analytical laboratory and resolve issues with sample analysis. • Receive data packages from the analytical laboratory and enter data into the database. • Provide the MSGP Project Lead with monthly invoice updates. • Perform V&V of field data submitted and uploaded from forms when samples are submitted to the SMO.
Operations Integration Office (OIO), Systems Integration (SI)	Perform V&V of data packages uploaded by the SMO or send data packages to a subcontractor company for independent V&V.

5.7 DISCHARGE MONITORING REPORTS

The Laboratory is required to submit analytical results of stormwater monitoring and to keep the results with the specific SWPPP. The Laboratory must submit analytical monitoring results obtained from each monitoring station associated with industrial activity on a MSGP Discharge Monitoring Report (MDMR) form (one form must be submitted for each storm event from which, a sample was collected).

MDMRs shall be written in accordance with ENV-RCRA-QP-044, *Preparing Storm Water Discharge Monitoring Reports (MDMRs) for the NPDES Multi-Sector General Permit*. MDMRs shall be submitted to EPA within 30 calendar days of receiving validated

analytical results. Refer to the DMR language under the SWPPP Section above for additional requirements.

Site analytical requirements are defined by the industrial activity in the MSGP permit. All MSGP analytes applicable to LANL are consistent with the requirements of 40 CFR Part 136, *Guidelines Establishing Test Procedures for the Analysis of Pollutants*.

Sample analytical requirements vary by site depending on the industrial activities performed at the site. Refer to Attachment 5 for a list of analytes by industrial sector. If an insufficient quantity of sample is available, then sample collection will be prioritized at that location for future events. Additional samples may be collected to meet permit requirements.

ENV-RCRA shall refer to the requirements of the 2008 Multi-Sector General Permit, and the most current MSGP Sampling and Analysis Plan to determine the priorities of required analyses.

The following table lists responsibilities:

Who	What
Project Lead	<ul style="list-style-type: none"> • Ensure implementing procedures for sample analyses are used. • Ensure that MDMRs are submitted to EPA and NMED in accordance with the MSGP.
MSGP Water Quality Compliance Personnel	Assure MDMRs are completed and certified as required by the MSGP and have received a full quality assurance review.

5.8 ADVERSE WEATHER CONDITIONS AND CLIMATES WITH IRREGULAR STORMWATER RUNOFF

Section 4.2.3 of the 2008 MSGP allows the industrial facility to take a substitute sample during the next qualifying storm event when adverse weather conditions prevent the collection of samples during a specific quarter. Adverse weather conditions are those that are dangerous or create inaccessibility for personnel, such as local flooding, high winds, or electrical storms, or situations that otherwise make sampling impractical, such as drought or extended frozen conditions. Documentation of the rationale for no visual assessment for the quarter must be included in the facility specific SWPPP.

Since LANL is located in an area where limited rainfall occurs during parts of the year (i.e., in a semi-arid climate) and has periods of freezing conditions, LANL has identified an alternative monitoring period of four quarters as follows for each calendar year.

- April 1-May 31

- June 1-July 31
- August 1-September 30
- October 1-November 30

The following table lists specific responsibilities.

Who	What
Project Lead	Ensure that the monitoring schedule is documented in facility specific SWPPPs and provided to EPA on the MDMRs.

5.9 REPORTING AND RECORDKEEPING

All monitoring data shall be collected in accordance with the requirements specified in the 2008 MSGP. LANL will submit monitoring results to EPA within 30 days of receiving validated laboratory results. The address for submittal of monitoring results is as follows.

U.S. Environmental Protection Agency
Office of Water, Water Permits Division
Mail Code 4203M, ATTN: MSGP Reports
1200 Pennsylvania Avenue, NW
Washington, D.C. 20460

LANL shall keep copies of the following documentation for a period of at least 3 years from the date that LANL's coverage under the MSGP expires or is terminated.

- SWPPP (including any modifications made during the term of the 2008 MSGP)
- Additional documentation requirements as identified in Section 5.4 of the MSGP
- All reports and certifications required by the MSGP
- Monitoring data
- Records of all data used to complete the NOI.

The following table lists specific responsibilities:

Who	What
Project Lead	Periodically audit MSGP records to ensure documentation of compliance is being retained.
Deployed Environmental Professionals	Retain records as required by the MSGP for industrial facilities located in their FOD.

5.10 BEST MANAGEMENT PRACTICES

It is critical that the Laboratory be able to effectively inspect and maintain the Best Management Practices that have been installed at various locations. Quarterly inspections must be completed and provided to the Project Lead for inclusion into the records system. In addition, the Project Leader conducts a Comprehensive Annual Site Inspection and writes a report to document the status of BMPs and other identified corrective actions. This report is sent to EPA each year. Laboratory management has made an investment in time and materials, in addition to a commitment to minimizing the potential migration of contaminants in stormwater. Report findings are evaluated and in conjunction with facility personnel, BMPs are modified, installed, or removed as necessary.

The following table lists responsibilities.

Who	What
Project Lead	Assist facility personnel and Deployed Environmental Professionals with implementation, inspection, and maintenance of BMPs at MSGP facilities.
Facility Management Support	<ul style="list-style-type: none"> • Coordinate with Project Lead and provide funding as needed to install, inspect, maintain and implement identified BMPs. • Certify the corrective actions identified by the Project Lead and/or facility personnel (or their representatives) for their individual facilities in the Annual Report.

5.11 INFORMATION MANAGEMENT

The Water Quality Database is a database information system designed in part to support the information management (IM) needs of the Laboratory’s MSGP. MSGP support includes stormwater discharge monitoring reporting, Geographic Information System (GIS) development, and other IM activities as needed.

The following table lists responsibilities:

Who	What
Project Lead	Coordinate with IM support personnel to meet regulatory requirements.

5.12 RESPONDING TO WATER QUALITY EXCEEDANCES

The identification of a pollutant source(s) contributing to a water quality exceedance will be addressed through the creation of a corrective action that is entered into the Corrective Acton

Report database in accordance with *ENV-DO-QP-113, Tracking Performance Feedback and Actions* and *ENV-RCRA-QP-022, MSGP Stormwater Corrective Actions*. Federal stormwater regulations implemented under the Laboratory's MSGP (40 CFR 122, EPA Administered Permit Programs: The National Pollutant Discharge Elimination System) require that corrective action be taken if exceedances of water quality standards or MSGP numeric effluent limits are identified. Corrective actions are typically accomplished by modifying, as appropriate, existing BMPs and SWPPPs.

When a water quality exceedance occurs, the Laboratory will submit the data on the required MDMRs, investigate the occurrence, and document corrective actions.

When an exceedance of the MSGP benchmark parameters is detected, the Project Lead will assure the analytical data is reviewed, notify appropriate SWPPP owners, and recommend and track corrective actions where required.

The following steps lead to corrective actions:

STEP	Action
1	Establish that an analytical result from a location is valid and has exceeded a standard or MSGP benchmark.
2	Evaluate and demonstrate that the analyte is of LANL origin, if possible.
3	Determine the source and assign responsibility for the corrective action.
4	Develop a corrective action plan.

The following table lists responsibilities:

Who	What
Project Lead	<ul style="list-style-type: none"> Assure that analytical data is reviewed and accurate. Notify appropriate SWPPP owners, Laboratory management, and Deployed Environmental Professionals. Develop a corrective action plan. Follow up with corrective actions if required. Track corrective actions.
Facility Management and DEP	<ul style="list-style-type: none"> Review analytical data with Project Lead and provide input into a possible corrective action necessary to improve water quality where needed. Evaluate and improve BMPs in accordance with site conditions, industry standards, and manufacturer

	recommendations.
--	------------------

5.13 INSTRUMENTATION AND EQUIPMENT

Compliance will be tracked by performing inspections of samplers and other associated equipment, inspecting BMPs, and conducting annual site compliance evaluations. Adequate records will be maintained to demonstrate the operating history of essential instrumentation and equipment.

LANL will properly operate and maintain all systems of monitoring and control and related appurtenances which are installed or used to achieve compliance with the MSGP and the SWPPP. Backup instrumentation and equipment will be timely deployed in the event of equipment failure.

Instrument calibration is essential for documenting the quality of data obtained with the instrument. All technical work that depends upon the accuracy of data will be performed using equipment for which the calibration status and limits of accuracy are known and controlled.

Field team personnel will calibrate and perform maintenance procedures on all monitoring and analytical field instruments to ensure accuracy of measurements and will maintain appropriate records of such activities. All field calibrations will be documented as prescribed by procedures or manufacturer’s instructions.

The following table lists specific responsibilities.

Who	What
Project Lead	<ul style="list-style-type: none"> • Ensure data are collected and equipment is operated and maintained in accordance with project requirements. • Provide equipment maintenance and calibration specifications and ensure MSGP Water Quality Compliance Team personnel operate and conduct field activities in accordance with implementing procedures and specific work orders.

6.0 DESIGN

Design activities will be conducted and reviewed in accordance with PD340, *Conduct of Engineering* and P341, *Engineering Process Manual*.

Design standards under this program include, but are not limited to temporary and permanent BMPs, corrective action measures, and stormwater monitoring support.

Design inputs will be specified and approved on a timely basis for making design decisions. Inputs will contain the level of detail required to permit the performance of design activities correctly.

Formal design reviews, including design verifications and evaluation of design changes, will be conducted to ensure that the design input is correctly incorporated into the design output. Changes to design will undergo the same review as the original design.

Verification and validation of the adequacy of designs are conducted before relying on the performance of the design function. Verification and validation are conducted in accordance with implementing procedures.

The following table lists responsibilities.

Who	What
Project Lead	<ul style="list-style-type: none"> • Provide input to the design process in accordance with appropriate standards, requirements, and implementing procedures. • Determine the qualifications required to perform a review of design documents. • Identify a resource with skills, knowledge, ability, training, and certifications required to complete the review of the facility engineering design documents. • Communicate the results of the review to the requestor.
ENV-CP Staff	<p>Review design documents and requests as assigned.</p> <p>Inform the Project Lead of concerns regarding the facility engineering designs.</p>

7.0 PROCUREMENT

Items and services required for this process are commercial grade in nature and no special procurement requirements or needs are necessary. All procurements will be made in accordance with P840-1, *Procurement Quality*. For items and all services for which special requirements are necessary, the Project Lead and project members will identify such items or services.

The following table lists responsibilities:

Who	What
Group Leader	Ensure all procurements are conducted in accordance with P840-1.
Project Lead	<p>Recommend to Group Leader contracting items and services.</p> <p>Develop acceptance criteria.</p>
ENV-CP Staff	Identify potential suppliers of products or services necessary to complete work activities that must be procured from outside ENV-RCRA.

8.0 INSPECTION AND ACCEPTANCE TESTING

Any materials or services will be inspected and/or tested prior to acceptance for use in this project in accordance with P330-8, *Inspection and Test for Acceptance*. Most supplies used during performance of project activities are commercial grade in nature and require no special acceptance practices or procedures.

The following table lists responsibilities:

Who	What
Group Leader	Ensure procedures for inspection meet <i>SD330, Los Alamos National Laboratory Quality Assurance Program</i> requirements.
Project Lead	Verify that all materials and services meet acceptance criteria.
ENV-CP Staff	Follow established procedures for inspection and acceptance testing.

9.0 MANAGEMENT ASSESSMENT

The ENV-CP Group conducts internal management assessments of projects and programs in accordance with the requirements in P328-3, *Management Assessment* and P328-4, *Management Observation and Verification*. Assessments of the program are documented and filed as records.

When violations of requirements are found during a management assessment, a nonconformance report is initiated in accordance with P330-6, *Nonconformance Reporting* for nonconforming items.

Nonconforming services or processes are tracked and documented in accordance with P322-4, *Issues and Corrective Action Management*.

The following table lists responsibilities:

Who	What
Group Leader	Ensure management self-assessments for the MSGP program are conducted as specified in implementing procedures.
Project Lead	Ensure program management self-assessments are conducted.

10.0 INDEPENDENT ASSESSMENT

Independent assessments are those assessments conducted by organizations external to ENV-RCRA. As required by the SD330, *Los Alamos National Laboratory Quality Assurance Program*, this program may be assessed by outside organizations in accordance with P328-2, *Independent Assessment*.

Periodically audits/assessments will be conducted, with input from the Project Lead identifying one or more areas of the project to be audited.

The following table lists responsibilities:

Who	What
Project Lead	<ul style="list-style-type: none"> • Approve audit schedules. • Provide input to the QA Specialist as to the content of audit. • Review audit reports for factual accuracy. Address all findings and implement corrective actions as appropriate.
QA Specialist	<ul style="list-style-type: none"> • Identify areas to be addressed during internal audits. • Contract with the Quality Management Group to perform annual internal audits. • Review audit procedures to ensure they meet the requirements in this section.
Team Members	<p>Cooperate with auditors by providing information, data, etc.</p> <p>Implement corrective actions as directed by the Project Lead.</p>

11.0 ATTACHMENTS

Attachment 1- MSGP Program Organization

Attachment 2 – Annual Reporting Form

Attachment 3 – Routine Inspection Form

Attachment 4 – MSGP Facilities and Storm Water Monitored Outfalls Associated with Industrial Activity 2011, Permit NMR05GB21

Attachment 5 – Pollutants under Impaired Waters Monitoring

Attachment 6 – Analytes by Industrial Sector

Attachment 7 – References and Guidance Documents

[Click here for "Required Read" credit.](#)

ATTACHMENT 1- MSGP PROGRAM ORGANIZATION

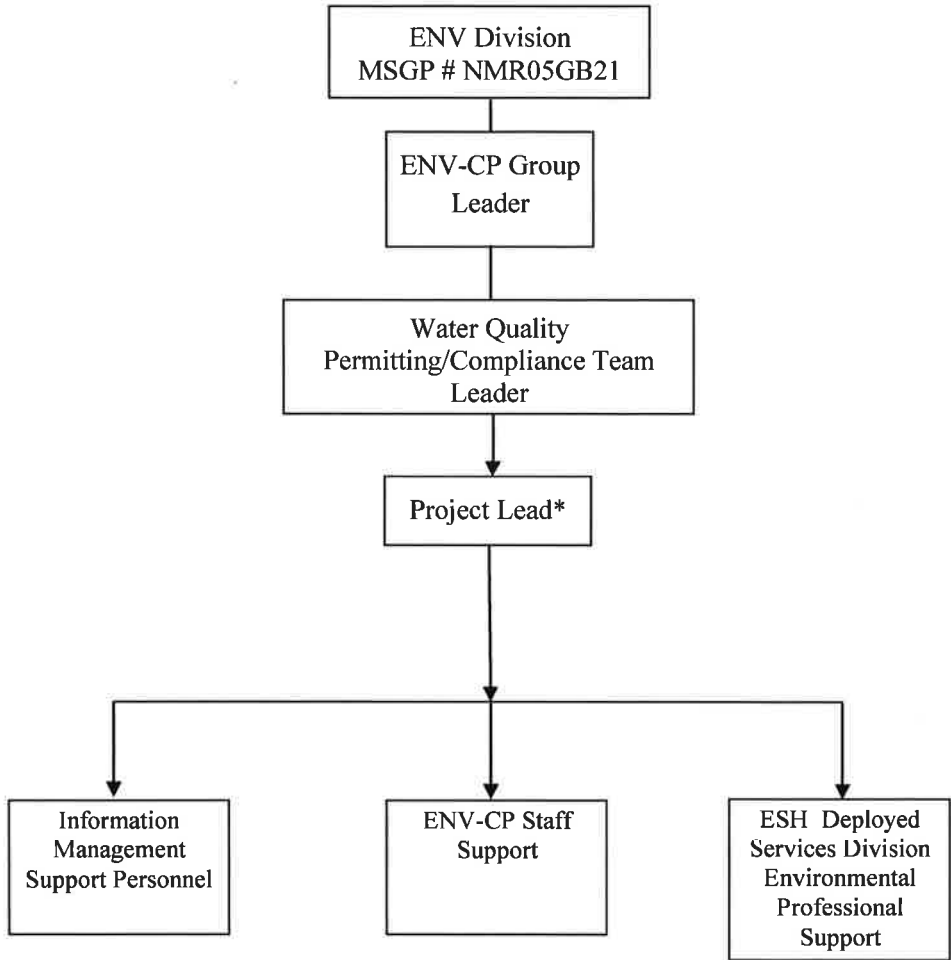

*Project Lead acts as liaison and will work directly with Team Leaders for staff assignments.

ATTACHMENT 2 – ANNUAL REPORTING FORM

NPDES Permit Tracking No.:

--	--	--	--	--	--	--	--	--	--



Annual Reporting Form

A. GENERAL INFORMATION

1. Facility Name:

--

2. NPDES Permit Tracking No.:

--

3. Facility Physical Address:

a. Street:

--

b. City:

--

c. State:

--

d. Zip Code:

	-	
--	---	--

4. Lead Inspectors Name:

--

 Title:

--

Additional Inspectors Name(s):

--

5. Contact Person:

--

 Title:

--

Phone:

	-		-	
--	---	--	---	--

 Ext.

--

 E-mail:

--

6. Inspection Date:

	/		/	
--	---	--	---	--

B. GENERAL INSPECTION FINDINGS

1. As part of this comprehensive site inspection, did you inspect all potential pollutant sources, including areas where Industrial activity may be exposed to stormwater?
 YES NO

If NO, describe why not:

NOTE: Complete Section C of this form for each industrial activity area inspected and included in your SWPPP or as newly identified in B.2 or B.3 below where pollutants may be exposed to stormwater.

2. Did this inspection identify any stormwater or non-stormwater outfalls not previously identified in your SWPPP? YES NO

If YES, for each location, describe the sources of those stormwater and non-stormwater discharges and any associated control measures in place:

NPDES Permit Tracking No.:

--	--	--	--	--	--	--	--	--	--	--	--	--

3. Did this inspection identify any sources of stormwater or non-stormwater discharges not previously identified in your SWPPP? YES NO

If YES, describe these sources of stormwater or non-stormwater pollutants expected to be present in these discharges, and any control measures in place:

4. Did you review stormwater monitoring data as part of this inspection to identify potential pollutant hot spots? YES NO NA, no monitoring performed

If YES, summarize the findings of that review and describe any additional inspection activities resulting from this review:

5. Describe any evidence of pollutants entering the drainage system or discharging to surface waters, and the condition of and around outfalls, including flow dissipation measures to prevent scouring:

6. Have you taken or do you plan to take any corrective actions, as specified in Part 3 of the permit, since your last annual report submission (or since you received authorization to discharge under this permit if this is your first annual report), including any corrective actions identified as a result of this annual comprehensive site inspection?

YES NO

If YES, how many conditions requiring review for correction action as specified in Parts 3.1 and 3.2 were addressed by these corrective actions?

--	--

NOTE: Complete the attached Corrective Action Form (Section D) for each condition identified, including any conditions identified as a result of this comprehensive stormwater inspection.

NPDES Permit Tracking No.:

--	--	--	--	--	--	--	--	--	--	--	--

C. INDUSTRIAL ACTIVITY AREA SPECIFIC FINDINGS

Complete one block for each industrial activity area where pollutants may be exposed to stormwater. Copy this page for additional industrial activity areas.

In reviewing each area, you should consider:

- Industrial materials, residue, or trash that may have or could come into contact with stormwater;
- Leaks or spills from industrial equipment, drums, tanks, and other containers;
- Offsite tracking of industrial or waste materials from areas of no exposure to exposed areas; and
- Tracking or blowing of raw, final, or waste materials from areas of no exposure to exposed areas.

INDUSTRIAL ACTIVITY AREA _____:

1. Brief Description:

2. Are any control measures in need of maintenance or repair?

YES NO

3. Have any control measures failed and require replacement?

YES NO

4. Are any additional/revised control measures necessary in this area?

YES NO

If YES to any of these three questions, provide a description of the problem: (Any necessary corrective actions should be described on the attached Corrective Action Form)

INDUSTRIAL ACTIVITY AREA _____:

1. Brief Description:

2. Are any control measures in need of maintenance or repair?

YES NO

3. Have any control measures failed and require replacement?

YES NO

4. Are any additional/revised c necessary in this area?

YES NO

If YES to any of these three questions, provide a description of the problem: (Any necessary corrective actions should be described on the attached Corrective Action Form)

INDUSTRIAL ACTIVITY AREA _____:

Brief Description:

2. Are any control measures in need of maintenance or repair?

YES NO

3. Have any control measures failed and require replacement?

YES NO

4. Are any additional/revised BMPs necessary in this area?

YES NO

If YES to any of these three questions, provide a description of the problem: (Any necessary corrective actions should be described on the attached Corrective Action Form)

NPDES Permit Tracking No.:

[Grid for NPDES Permit Tracking No.]

NOTE: Copy this page and attach additional pages as necessary

INDUSTRIAL ACTIVITY AREA _____:

1. Brief Description:

2. Are any control measures in need of maintenance or repair? YES NO

3. Have any control measures failed and require replacement? YES NO

4. Are any additional/revised BMPs necessary in this area? YES NO

If YES to any of these three questions, provide a description of the problem: (Any necessary corrective actions should be described on the attached Corrective Action Form)

INDUSTRIAL ACTIVITY AREA _____:

1. Brief Description:

2. Are any control measures in need of maintenance or repair? YES NO

3. Have any control measures failed and require replacement? YES NO

4. Are any additional/revised BMPs necessary in this area? YES NO

If YES to any of these three questions, provide a description of the problem: (Any necessary corrective actions should be described on the attached Corrective Action Form)

INDUSTRIAL ACTIVITY AREA _____:

1. Brief Description:

2. Are any control measures in need of maintenance or repair? YES NO

3. Have any control measures failed and require replacement? YES NO

4. Are any additional/revised BMPs necessary in this area? YES NO

If YES to any of these three questions, provide a description of the problem: (Any necessary corrective actions should be described on the attached Corrective Action Form)

NPDES Permit Tracking No.:

--	--	--	--	--	--	--	--	--	--	--	--	--	--	--	--	--	--	--	--

D. CORRECTIVE ACTIONS

Complete this page for each specific condition requiring a corrective action or a review determining that no corrective action is needed. Copy this page for additional corrective actions or reviews.

Include both corrective actions that have been initiated or completed since the last annual report, and future corrective actions needed to address problems identified in this comprehensive stormwater inspection. Include an update on any outstanding corrective actions that had not been completed at the time of your previous annual report.

1. Corrective Action # of for this reporting period.

2. Is this corrective action:

- An update on a corrective action from a previous annual report; or
- A new corrective action?

3. Identify the condition(s) triggering the need for this review:

- Unauthorized release or discharge
- Numeric effluent limitation exceedance
- Control measures inadequate to meet applicable water quality standards
- Control measures inadequate to meet non-numeric effluent limitations
- Control measures not properly operated or maintained
- Change in facility operations necessitated change in control measures
- Average benchmark value exceedance
- Other (describe): _____

4. Briefly describe the nature of the problem identified:

5. Date problem identified: / /

6. How problem was identified:

- Comprehensive site inspection
- Quarterly visual assessment
- Routine facility inspection
- Benchmark monitoring
- Notification by EPA or State or local authorities
- Other (describe): _____

7. Description of corrective action(s) taken or to be taken to eliminate or further investigate the problem (e.g., describe modifications or repairs to control measures, analyses to be conducted, etc.) or if no modifications are needed, basis for that determination:

8. Did/will this corrective action require modification of your SWPPP? YES NO

9. Date corrective action initiated: / /

10. Date correction action completed: / / or expected to be completed: / /

11. If corrective action not yet completed, provide the status of corrective action at the time of the comprehensive site inspection and describe any remaining steps (including timeframes associated with each step) necessary to complete corrective action:

NPDES Permit Tracking No.:

Grid for NPDES Permit Tracking No.

E. ANNUAL REPORT CERTIFICATION

1. Compliance Certification

Do you certify that your annual inspection has met the requirements of Part 4.2 of the permit, and that, based upon the results of this inspection, to the best of your knowledge, you are in compliance with the permit? YES NO

If NO, summarize why you are not in compliance with the permit:

2. Annual Report Certification

I certify under penalty of law that this document and all attachments were prepared under my direction or supervision in accordance with a system designed to assure that qualified personnel properly gathered and evaluated the information submitted. Based on my inquiry of the person or persons who manage the system, or those persons directly responsible for gathering the information, the information submitted is, to the best of my knowledge and belief, true, accurate, and complete. I am aware that there are significant penalties for submitting false information, including the possibility of fine and imprisonment for knowing violations.

Authorized Representative
Printed Name:

Grid for Authorized Representative Printed Name

Title:

Grid for Title

Signature: _____

Date Signed: _____

ATTACHMENT 3 – ROUTINE INSPECTION FORM

Name of Facility:		Responsible FOD (Name & Organization):			
Qualified Inspector(s): Others Present:		Date of inspection (MM/DD/YYYY): Time of inspection:			
Weather: <input type="checkbox"/> Clear <input type="checkbox"/> Cloudy <input type="checkbox"/> Rain <input type="checkbox"/> Sleet <input type="checkbox"/> Fog <input type="checkbox"/> Snow <input type="checkbox"/> High Winds <input type="checkbox"/> Other: _____ Temperature: _____ ° F Is Inspection Being Conducted During a Storm Water Discharge? <input type="checkbox"/> Yes <input type="checkbox"/> No					
#	Structural Control Measures (BMP)s	Location	Operating Effectively (Yes or No)?	If No, Need to Maintain (M), Repair (R) or Replace (RP)?	Corrective Action Needed and Notes (Identify needed maintenance and repairs, or any failed control measures that need replacement)
1.					
2.					
3.					
4.					
5.					
6.					
7.					
8.					
9.					
10.					
11.					
12.					
Were additional BMPs or Control Measures implemented? <input type="checkbox"/> Yes <input type="checkbox"/> No Describe:					
Were previously identified conditions corrected before the next anticipated storm event? <input type="checkbox"/> Yes <input type="checkbox"/> No if No, describe reason:					
Area/Activity	Inspected ?	Controls Adequate?	Corrective Action Needed and Notes (List area letter with comments below)		
A. Material loading/unloading & storage areas					
B. Equipment operations & maintenance areas					
C. Fueling Areas					
D. Outdoor vehicle & equipment washing areas					
E. Waste Handling & disposal areas					
F. Erodible areas / construction					
G. Non-storm water / illicit connections					

H. Salt storage piles or pile containing salt			
I. Dust generation & vehicle tracking			
Are the SWPP Plan maintenance, schedules and procedures being implemented at the facility? <input type="checkbox"/> Yes <input type="checkbox"/> No			
Were any Corrective Actions initiated or completed? <input type="checkbox"/> Yes <input type="checkbox"/> No Describe:			
Are there any conditions requiring Corrective Action? <input type="checkbox"/> Yes <input type="checkbox"/> No If Yes, List Number of Corrective Actions Required _____			
(Note – You need enter a Corrective Action in the MSGP Corrective Action Report database for each listed)			

Stormwater MSGP for Industrial Activities Program	No. ENV-CP-QAPP-MSGP, R5	Page 37 of 40
Effective Date: 11/04/2013		

**ATTACHMENT 4 -- MSGP FACILITIES AND STORM WATER MONITORED OUTFALLS ASSOCIATED WITH INDUSTRIAL ACTIVITY 2011,
PERMIT NMR05GB21**

Location	Permitted Facility	Operation	Activity	Sector	Monitored Outfall	Canyon
TA-15-185	TA-15-185 PHERMEX	Vehicle Maintenance Shop	Vehicle Maintenance	P	15-PHRMX-1	• Water
TA-3-0034	TA-3-0034 Metal Shop	Fabricated Metals	Fabricated Metals	AA	3-MST-1	• Mortandad
TA-3-22	TA-3-22 Power & Steam Plant	Power Plant	Steam Electric Power	O	3-PSP-1 3-PSP-5 3-PSP-8	• Sandia • •
TA-3-38	TA-3-38 Metals Fab Shop	Metal Shop	Fabricated Metals	AA	3-MFS-1	• Sandia
TA-3-39	TA-3-39 & 102 Metal Shop	Metal Shop	Fabricated Metals	AA	3-TS-1	• Pajarito
TA-3-66	TA-3-66 Sigma Complex	Sigma Foundry	Primary Metals	F	3-Sigma-6	• Sandia
TA-54	TA-54 Area G	Area G - South Side	TSD	K	54-G-1	• Pajarito
TA-54	TA-54 Area G	Area G - North Side	TSD	K	54-G-2	• Canada del Buey
TA-54	TA-54 Area G	Area G - South Side	TSD	K	54-G-3	• Pajarito
TA-54	TA-54 Area G	Area G - South Side	TSD	K	54-G-4	• Pajarito
TA-54	TA-54 Area L	Area L	TSD	K	54-L-1	• Canada del Buey
TA-54-38	TA-54 RANT	RANT	TSD	K	54-RANT-1	• Canada del Buey
TA-60	TA-60 Asphalt Batch Plant	Asphalt Batch Plant	Asphalt Paving	D	60-ABP-1	• Mortandad
TA-60	TA-60 MRF	Materials Recycling Facility	Scrap Recycling	N	60-MRF-1	• Sandia
TA-60-250	TA-60 Roads and Grounds	Roads & Grounds Facility	Vehicle Maintenance & Storage	P	60-RG-1 60-RG-3 60-RG-8	• Mortandad • Sandia • Sandia
TA-60-1	TA-60-1 Heavy Equipment Yard	Motor pool	Vehicle Maintenance	P	60-HEY-2	• Sandia
TA-60-2	TA-60-2 Warehouse	Motor pool	Vehicle Maintenance	P	60-WH-1	• Sandia
TA-9-28	TA-9-28 Heavy Equipment Maintenance	Motor pool	Vehicle Maintenance	P	9-HEM-1	• Pajarito

Stormwater MSGP for Industrial Activities Program	No. ENV-CP-QAPP-MSGP, R5	Page 38 of 40
	Effective Date: 11/04/2013	

ATTACHMENT 5 – POLLUTANTS UNDER IMPAIRED WATERS MONITORING

Permitted Facility	Monitored Outfall	Assessment Unit	Canyon	Pollutant
TA-54 Area G TA-54 Area L TA-54-RANT	54-G-2 54-L-1 54-RANT-1	NM-128.A_00	Canada del Buey (within LANL)	PCBs Aluminum Gross Alpha
TA-54 Area G TA-54 Area G TA-54 Area G	54-G-1 54-G-3 54-G-4	NM-128.A_08	Pajarito Canyon (within LANL below Arroyo de la Delfe)	PCBs Aluminum Copper Gross Alpha
TA-15-185 PHERMEX	15-PHRMX-1	NM-128.A_13	Water Canyon (within LANL below Area-A Canyon)	PCBs Aluminum Gross Alpha
TA-3-39 & 102 Metal Shop	3-TS-1	NM-128.A_15	Two Mile Canyon (Pajarito to headwaters)	PCBs Aluminum Gross Alpha
TA-9-28 Heavy Equipment Maintenance	9-HEM-1	NM-128.A_16	Arroyo de la Delfe (Pajarito Canyon to headwaters)	Aluminum Mercury Gross Alpha
TA-60 Asphalt Batch Plant TA-3-0034 Metal Shop TA-60 Roads and Grounds	60-ABP-1 3-MST-1 60-RG-1	NM-9000.A_042	Mortandad Canyon (within LANL)	Aluminum Copper Gross Alpha
TA-3-38 Metals Fab Shop TA-3-22 Power & Steam Plant TA-3-22 Power & Steam Plant TA-3-22 Power & Steam Plant TA-3-66 Sigma Complex TA-60-1 Heavy Equipment Yard TA-60 MRF	3-MFS-1 3-PSP-1 3-PSP-5 3-PSP-8 3-Sigma-6 60-HEY-2 60-MRF-1	NM-9000.A_047	Sandia Canyon (Sigma Canyon to NPDES outfall 001)	PCBs Aluminum Copper Gross Alpha Mercury
TA-60 Roads and Grounds TA-60 Roads and Grounds TA-60-2 Warehouse	60-RG-3 60-RG-8 60-WH-1			

ATTACHMENT 6 -- ANALYTES BY INDUSTRIAL SECTOR

Permitted Facility	Monitored Outfall	Sector	Activity	Analyte	Monitoring Requirement
TA-3-0034 Metal Shop TA-3-38 Metals Fab Shop TA-3-39 & 102 Metal Shop	3-MST-1	AA	Fabricated Metals	Aluminum	Quarterly Benchmark Monitoring (QBM)
	3-MFS-1			Iron	
	3-TS-1			Nitrate plus Nitrite Nitrogen Zinc	
TA-60 Asphalt Batch Plant	60-ABP-1	D	Asphalt Paving	Oil and Grease pH Total Suspended Solids	Effluent Limitations Guidelines (ELG) ELG QBM and ELG
TA-3-66 Sigma Complex	3-Sigma-6	F	Primary Metals	Copper Zinc	QBM QBM
TA-54 Area G	54-G-1	K	Treatment, Storage or Disposal Facility (TSD)	Ammonia	QBM
TA-54 Area G	54-G-2			Arsenic	QBM
TA-54 Area G	54-G-3			Cadmium	QBM
TA-54 Area G	54-G-4			Chemical Oxygen Demand	QBM
TA-54 Area L	54-L-1			Cyanide	QBM
TA-54 RANT	54-RANT-1			Lead	QBM
				Magnesium	QBM
				Mercury	QBM
				Selenium	QBM
				Silver	QBM
TA-60 MRF	60-MRF-1	N	Scrap Recycling	Aluminum Chemical Oxygen Demand Copper Iron Lead Total Suspended Solids Zinc	QBM QBM QBM QBM QBM QBM QBM
TA-3-22 Power & Steam Plant	3-PSP-1 3-PSP-5 3-PSP-8	O	Steam Electric Power	Iron	QBM

Stormwater MSGP for Industrial Activities Program	No. ENV-CP-QAPP-MSGP, R5	Page 40 of 40
Effective Date: 11/04/2013		

ATTACHMENT 7 – REFERENCES AND GUIDANCE DOCUMENTS

- 40 CFR 122, *EPA Administered Permit Programs*
- 40 CFR 136, *Guidelines Establishing Test Procedures for the Analysis of Pollutants*.
- Clean Water Act, Title 33 U.S.C. 1251
- DOE O 414.1C, *Quality Assurance*
- DOE Order 450.1, *Environmental Protection Program*
- DOE Order 5400.5, *Radiation Protection of Public and Environment*
- EPA QA/G-4, *Guidance for the Data Quality Objectives Process*

LANL Documents:

- P322-4, *Laboratory Performance, Feedback, and Improvement*
- P328-3, *Management Assessments*
- P328-4, *Management Observation and Verification*
- P330-6, *Nonconformance Reporting*
- P330-8, *Inspection and Test for Acceptance*
- P340, *Conduct of Engineering*
- P341, *Engineering Process Manual*
- P401, *Procedure to Identify, Communicate, and Implement Environmental Requirements*
- P407, *Water Quality*
- P840-1, *Procurement Quality*

ENV Documents:

- ENV-DO-QP-105, *Preparation, Review, and Approval of Procedures*
- ENV-DO-QP-106, *Document Control*
- ENV-DO-QP-113, *Tracking Performance Feedback and Actions*
- ENV-DO-QP-115, *Personnel Training*
- ENV-CP-QP-022, *MSGP Storm Water Corrective Actions*
- ENV-CP-QP-044, *Preparing Storm Water Discharge Monitoring Reports (MDNRs) for NPDES MSGP*
- ENV-CP-QP-047, *Inspecting Storm Water Runoff Samplers and Retrieving Samples*
- ENV-CP-QP-048, *Processing MSGP Storm Water Samples*
- ENV-CP-QP-064, *Multi-Sector General Permit Storm Water Visual Inspections*
- ENV-WQH-QP-029, *Creating and Maintaining a Chain of Custody*
- Surface Water Monitoring Plan, October 2001, Rev. 0.0

ENV-RCRA-QP-022.2



Effective Date: February 28, 2013

Next Review Date: January 28, 2015

Environment, Safety, Health Directorate

**Environmental Protection – Water Quality and RCRA
Quality Procedure**

MSGP Storm Water Corrective Actions

Reviewers:

Name:	Organization:	Signature:	Date:
Melanie Lamb	ENV-QPMO QA Specialist	Signature on file	1/4/13

Derivative Classifier: **Unclassified**

Name:	Organization:	Signature:	Date:
Catherine Hayes	ENV-RCRA	Signature on file	2/8/13

Approval Signatures:

Subject Matter Expert: Holly Wheeler	Organization: ENV-RCRA	Signature: Signature on file	Date: 1/28/13
Responsible Line Manager: Terrill Lemke	Organization: ENV-RCRA Team Lead	Signature: Signature on file	Date: 2/8/13
Responsible Line Manager: Anthony Grieggs	Organization: ENV-RCRA Group Leader	Signature: Signature on file	Date: 2/28/13

CONTROLLED DOCUMENT

This copy is uncontrolled. The controlled copy can be found on the ENV Division Web page.

Users are responsible for ensuring they work to the latest approved version.

Title: MSGP Storm Water Corrective Actions	No. ENV-RCRA-QP-022.2	Page 2 of 23
	Effective Date: February 28, 2013	

History of Revisions

Document Number <i>[Include revision number, beginning with Revision 0]</i>	Effective Date <i>[Document Control Coordinator inserts effective date]</i>	Description of Changes <i>[List specific changes made since the previous revision]</i>
0	08/10	New Document.
1	11/10	Incorporated ENV-RCRA-QP-062 <i>MSGP Routine Inspections</i> into this document.
2	01/13	Biennial revision, new template implemented.

Table of Contents

1.0	PURPOSE	4
2.0	SCOPE	4
2.1	Hazard review	4
3.0	RESPONSIBILITIES	4
3.1	Roles and Responsibilities	5
3.2	Prerequisites	6
4.0	DOCUMENT CONTROL/RECORDS MANAGEMENT	7
5.0	WORK PROCESSES	7
5.1	Identifying Corrective Actions.....	7
5.2	Routine Inspections.....	8
5.3	Comprehensive Inspections	8
5.4	Spills.....	9
5.5	Allowable Non-Storm Water Discharges.....	9
5.6	Entering Corrective Actions.....	10
5.7	Updating Corrective Actions.....	12
5.8	Validating Corrective Actions.....	12
5.9	Institutional Performance Feedback and Improvement Tracking System (PFITS).....	13
5.10	Notifications for New and Overdue Corrective Actions.....	14
6.0	REFERENCES	14
7.0	DEFINITIONS	15
8.0	ATTACHMENTS	15
	ATTACHMENT 1- Annual Reporting Form	16
	ATTACHMENT 2- NPDES Multi-Sector General Permit Routine Inspection Form	22

Title: MSGP Storm Water Corrective Actions	No. ENV-RCRA-QP-022.2	Page 4 of 23
Effective Date: February 28, 2013		

1.0 PURPOSE

This procedure is written to provide requirements for identifying, documenting and entering corrective actions into the ENV-RCRA MSGP Corrective Action Report Findings database.

2.0 SCOPE

Requirements set forth in this document apply to Los Alamos National Laboratory industrial facilities covered by the National Pollutant Discharge Elimination System (NPDES) Storm Water Multi-Sector General Permit (MSGP). This “general permit” requires identification, documentation, tracking and reporting of corrective actions in accordance with sections 2.2.1, 3, 4.1.2, 4.2.2, 4.3.2, 5.0, 5.2, 5.4, 6.2.1, 6.2.1.2, 7.2 and Appendices B and I.

2.1 HAZARD REVIEW

The work described in this procedure is office work only and has a **LOW hazard** rating as documented by submittal of a completed [ENV Low Hazard Verification form](#) to the Quality Assurance Specialist.

3.0 RESPONSIBILITIES

The following personnel require training before implementing this procedure:

- Group and Team Leader
- ENV-RCRA MSGP Storm Water compliance personnel
- Deployed Environmental Professionals (DEPs)
- Other LANL or subcontract personnel identified as being required to conduct storm water assessments as part of their job duties.

In addition to training to this procedure, the following training is also required prior to performing this procedure:

- [ENV-RCRA QAPP-MSGP Quality Assurance Project Plan for the Storm Water Multi-Sector General Permit for Industrial Activities](#)

The training method for this procedure is “self-study” (required read). For ENV-RCRA staff, this is documented in accordance with [ENV-DO-QP-115, Personnel Training](#). Other participating groups may require training documentation pursuant to local procedures.

Actions specified within this procedure, unless preceded with “should” or “may”, are to be considered mandatory (i.e., “shall”, “will”, “must”).

Title: MSGP Storm Water Corrective Actions	No. ENV-RCRA-QP-022.2	Page 5 of 23
Effective Date: February 28, 2013		

3.1 ROLES AND RESPONSIBILITIES

3.1.1 ENV-RCRA MSGP STORM WATER TEAM

ENV-RCRA MSGP Storm Water Team members will be fully knowledgeable of the specific regulatory requirements identified in the 2008 MSGP and are responsible for ensuring compliance with these requirements and entering corrective actions. Team members will evaluate corrective actions that the DEPs enter into the ENV-RCRA MSGP Corrective Action Report Findings database and modify them as needed for quality assurance. This team will also periodically review open corrective actions and follow up with the DEPs, ES&H Managers, or Upper Management, as deemed necessary, to ensure close out of the corrective action. The team members will notify upper management of instances of non-compliance with the permit. A team member may also be responsible for responding to the regulatory authority (EPA) regarding identified storm water issues and/or negotiate settlement of any identified issues.

3.1.2 DEPLOYED ENVIRONMENTAL PROFESSIONALS

DEPs will be fully knowledgeable of the site specific Storm Water Pollution Prevention Plan (SWPPP) and corrective action requirements identified in the MSGP for the facilities they are deployed to. In addition, they shall be appropriately trained to meet the job qualifications identified in the *Quality Assurance for Storm Water Multi-Sector General Permit for Industrial Activities Program* (ENV-RCRA-QAPP-MSGP) and shall be familiar with the regulatory requirements identified in the 2008 MSGP. Further, they shall be familiar with facility operations so that potential pollution discharge sources can be determined and corrective actions can be identified.

The DEPs are responsible for identifying and entering corrective actions observed at their industrial facilities into the ENV-RCRA MSGP Corrective Action Report Findings database. They are also responsible for updating corrective actions in a timely manner that cannot be implemented immediately. They will work with the ES&H Manager and ENV-RCRA storm water personnel to ensure identified corrective actions are implemented by overseeing repairs and/or improvements or instituting additional controls. If it is determined that corrective actions are necessary following an assessment, any modification to the control measures must be made before the next storm event if possible, or as soon as practicable following that storm event.

NOTE: These time intervals are not grace periods, but are schedules considered reasonable for documenting your finding(s) and for making repairs and improvements. They are included in the MSGP Permit to ensure that the conditions prompting the need for these repairs and improvements are not allowed to persist indefinitely (see Section 3.3 of the 2008 MSGP). In no instance will the corrective action remain open indefinitely.

Title: MSGP Storm Water Corrective Actions	No. ENV-RCRA-QP-022.2	Page 6 of 23
Effective Date: February 28, 2013		

3.1.3 ENV-RCRA STORM WATER TEAM LEADER

The ENV-RCRA Storm Water Team Leader is responsible for compliance oversight relative to the 2008 MSGP. The Team Leader will ensure costs needed to implement the regulatory requirements identified in the 2008 MSGP are identified and environmental risks are assessed. Upper management will be notified of these costs or environmental risks, as deemed necessary. In the event there is a dispute regarding the regulatory requirements contained in the MSGP, the Team Leader will make the final determination of the required action. The Team Leader will notify upper management of instances of non-compliance with the permit.

3.1.4 ENV-RCRA GROUP LEADER

The ENV-RCRA Group Leader or designee is responsible for ensuring there is adequate funding to implement the regulatory requirements identified in the 2008 MSGP. The Group Leader also acts as the duly authorized signatory that certifies the reports. The Group Leader will notify upper management of instances of non-compliance with the permit or other identified environmental risk.

3.1.5 ES&H MANAGER

The ES&H manager shall identify funding for their industrial facilities to ensure compliance with the 2008 MSGP. The ES&H Manager is also responsible for ensuring that industrial facilities are complying with the 2008 MSGP permit and notifying upper management of instances of non-compliance with the permit or other identified environmental risk.

3.1.6 FACILITIES OPERATIONS DIRECTOR

The Facilities Operations Director (FOD) provides organizational leadership to ensure that all facility and programmatic activities under their authority are performed in compliance with the 2008 MSGP. The FOD is also responsible for establishing an environmental compliance envelope. It is the FOD's responsibility to maintain trained and qualified Environmental Professionals and Waste Management Coordinators on staff.

3.1.7 COMPUTER PROGRAMMER

Maintains and updates the ENV-RCRA MSGP Corrective Action Report Findings database as requested by MSGP storm water personnel.

3.2 PREREQUISITES

In addition to training to this procedure, the following training is also required prior to performing this procedure:

- [ENV-RCRA QAPP-MSGP, Quality Assurance Project Plan for the Storm water Multi-Sector General Permit for Industrial Activities Program](#)

4.0 DOCUMENT CONTROL/RECORDS MANAGEMENT

The following records generated as a result of this procedure are to be submitted to the designated RM-POC in accordance with [ENV-DO-QP-110, Records Management](#) and filed in project files.

- MSGP Comprehensive Site Inspection Annual Report
- Completed Routine Inspection Forms
- Electronic records within the ENV-RCRA MSGP Corrective Action Report Findings database.
- Copies of automated e-mail notifications

5.0 WORK PROCESSES

5.1 IDENTIFYING CORRECTIVE ACTIONS

If any of the following conditions occur, the DEP or ENV-RCRA storm water team member must review and revise the selection, design, installation, and implementation of control measures to ensure that the condition is eliminated and will not be repeated in the future:

- An unauthorized release or discharge (e.g., spill, leak, or discharge of non-storm water not authorized by the 2008 MSGP);
- You become aware, or EPA determines, that your control measures are not stringent enough for the discharge to meet applicable water quality standards;
- An inspection or evaluation of the facility by an EPA official and/or local or State entity, determines that modification to the control measures are necessary to meet the non-numeric effluent limits in the 2008 MSGP;
- You find in the routine facility inspection, quarterly visual assessment, or comprehensive site inspection that the control measures are not being properly operated and maintained;
- Construction or a change in design, operation, or maintenance at the facility significantly changes the nature of pollutants discharged in storm water from the facility, or significantly increases the quantity of pollutants discharged; or
- The average of four quarterly sampling results exceeds an applicable benchmark. If less than four benchmark samples have been taken, but the results are such that an exceedence of the four quarter average is mathematically certain, (i.e., if the sum of quarterly sample results to date is more than four times the benchmark level) this is considered a benchmark exceedence, triggering this review;
- If effluent limitation guidelines are exceeded at the Asphalt Batch Plant (Sector D); or
- If impaired water quality standards are exceeded.

Title: MSGP Storm Water Corrective Actions	No. ENV-RCRA-QP-022.2	Page 8 of 23
Effective Date: February 28, 2013		

5.2 ROUTINE INSPECTIONS

Routine inspections shall be conducted by the DEP (or a qualified member if the DEP is not trained and qualified) at all areas of the facility where industrial materials or activities are exposed to storm water, and of all storm water control measures used to comply with the effluent limits contained in the 2008 MSGP. Routine inspections shall be conducted at least quarterly; however, some facilities conduct monthly inspections (as specified in the facility specific SWPPP). Routine inspections shall be conducted during periods when the facility is in operation. A certified copy of completed Routine Inspection Forms shall be maintained in the facility’s SWPPP.

At least once each calendar year, the routine facility inspections must be conducted during a period when a storm water discharge (either rain or snow) is occurring. The DEP(s) or storm water personnel from ENV-RCRA are responsible for identifying and entering corrective actions observed during the routine inspections into the ENV-RCRA MSGP Corrective Action Report Findings database. The database is set up to allow access for all identified DEPs associated with a particular FOD if the FOD has more than one DEP. Contact a member of the ENV-RCRA storm water team if you do not have access to this database and the FOD has assigned you responsibility for MSGP corrective actions.

NOTE: If the industrial facility is inactive and unstaffed and there are no industrial materials or activities exposed to storm water, routine inspections may not be required. A determination of whether a facility is inactive or unstaffed shall be made in coordination with storm water personnel from ENV-RCRA as there are specific documentation and certification requirements that have to be met prior to discontinuing routine inspections.

5.3 COMPREHENSIVE INSPECTIONS

Qualified ENV-RCRA storm water personnel will conduct one comprehensive inspection of all industrial facilities and those that meet the “no exposure” criteria subject to the 2008 MSGP before September 29th of each year. At least one member of the facility’s storm water pollution prevention team shall participate in this inspection. This is usually the DEP.

This inspection must cover all areas of the industrial facility affected by the requirements in the 2008 MSGP including the areas identified in the SWPPP as potential pollutant sources where industrial material or activities are exposed to storm water, areas where control measures are used to comply with the effluent limits, and areas where spills and leaks have occurred in the past 3 years. The inspector must include review of the monitoring data (analytical results from benchmark and impaired waters and visual assessments) collected that calendar year as part of the comprehensive inspection. Inspectors must examine the following at a minimum:

- Industrial materials, residue, or trash that may have or could come into contact with storm water;
- Leaks or spills from industrial equipment, drums, tanks, and other containers;

Title: MSGP Storm Water Corrective Actions	No. ENV-RCRA-QP-022.2	Page 9 of 23
	Effective Date: February 28, 2013	

- Offsite tracking of industrial or waste materials, or sediment where vehicles enter or exit the site;
- Tracking or blowing of raw, final, or waste materials from areas of no exposure to exposed areas; and
- Control measures needing replacement, maintenance, or repair.
- Storm water controls measures required by the 2008 MSGP must be observed to ensure that they are functioning correctly.

NOTE: The annual comprehensive site inspection may also be used as one of the routine inspections, as long as all components of both types of inspections are included.

ENV-RCRA will then enter all identified corrective actions into the ENV-RCRA MSGP Corrective Action Report Findings database. It is the responsibility of the DEP to update the database to reflect updates to these corrective actions.

Information compiled during the comprehensive inspection is used to complete the Annual Report. This report shall be submitted to EPA (postmarked) within 45 days of the last facility inspection completed in September of each year. For example, if the last facility was inspected (as part of the comprehensive site inspection) on September 22, the report shall be postmarked before or on November 6th. A complete certified copy of the Annual Report shall be maintained in the facility's SWPPP.

5.4 SPILLS

All leaks or spills shall be cleaned up immediately and entered into the ENV-RCRA MSGP Corrective Action Report Findings database. This can be done by either the DEP or an ENV-RCRA MSGP storm water team member. If the spill is immediately cleaned up, and controls are put in place to prevent further leakage, the corrective action can be closed.

5.5 ALLOWABLE NON-STORM WATER DISCHARGES

The following are allowable non-storm water discharges authorized by the 2008 MSGP:

- Discharges from fire-fighting activities;
- Fire hydrant flushing;
- Potable water, including water line flushings;
- Uncontaminated condensate from air conditioners, coolers, and other compressors and from the outside storage of refrigerated gases or liquids;
- Irrigation drainage;
- Landscape watering provided all pesticides, herbicides, and fertilizer have been applied in accordance with the approved labeling;
- Pavement wash waters where no detergents are used and no spills or leaks of toxic or hazardous material have occurred (unless all spilled material has been removed);

- Routine external building washdown that does not use detergents; and
- Uncontaminated ground water or spring water.

Any person authorized to conduct work at LANL can identify a potential storm water issue. If this occurs, they should contact the DEP or an ENV-RCRA MSGP storm water team member who will determine if a corrective action is needed.

5.6 ENTERING CORRECTIVE ACTIONS

To enter a corrective action into the ENV-RCRA MSGP Corrective Action Report Findings database, perform the following steps:

NOTE: Be clear and concise, use correct grammar and punctuation, and correct any spelling errors. This information will be used to populate a report that will be submitted to the EPA. Therefore, it is critical that all information entered into the ENV-RCRA MSGP Corrective Action Report Findings database is correct and meets these criteria.

Step	Action
1	<p>From this web page: http://int.lanl.gov/environment/water/guidance/swmgp.shtml, under the heading “Compliance Tools”. Click on the link “MSGP Corrective Action Report Findings Database”</p> <p>Click on “Enter New Corrective Action.”</p>
2	<p>Under the “Corrective Action Header” tab, enter the following:</p> <ul style="list-style-type: none"> • Facility Name by clicking on the “List” tab and selecting a facility. • Date Problem was Identified (mm/dd/yyyy) • Date of Notification to ENV-RCRA (mm/dd/yyyy) • FOD Responsible for CA (Name & Org) by clicking in the box. FOD designations (for example “STO”) and the associated name will come up. Just select the appropriate FOD. <p>NOTE: Contact the MSGP Project Leader at 667-1312 or hbensen@lanl.gov if the FOD name or organization is incorrect, so this can be corrected.</p> <ul style="list-style-type: none"> • Describe Specific Evaluation Location (for example “Northeast corner of Building TA-3-66”) • Inspector Z-Number by clicking in the box, which will populate it with your Z number. In most instances, the DEP should be identified as the inspector. Note: If you are entering the CA and are not the DEP, you will have to enter the DEP’s Z number or they will not have the ability to update the corrective action. <p>Once all of the above information is entered correctly, click “Save” and go</p>

	<p>to Step 3. All boxes identified with a red asterisk are “required fields” and shall be filled out. Note: The system will automatically assign a Corrective Action Report ID number.</p>
3	<p>Click “Go To Corrective Action Details” in the middle of the screen.</p> <p>Under the “Corrective Action Details” tab, enter the following:</p> <ul style="list-style-type: none"> • Identify the condition triggering the need for this review by clicking on the “List” tab and selecting an option or selecting “Other” and entering a description of the condition. • Briefly describe the nature of the problem identified during the inspection (e.g., erosion, damage to a BMP, trash, spill, etc.) and the specific evaluation location. <p>NOTE: Spills or other emergency situations may identify the need for a corrective action that was not identified during an inspection.</p> <ul style="list-style-type: none"> • How the problem was identified by clicking on the “List” tab and selecting an option or selecting “Other” and entering a description of the problem. • Description of the corrective action taken, or to be taken, to eliminate or further investigate the problem (e.g., describe modifications or repairs to control measures, analyses to be conducted, etc.) or if no modifications are needed, the basis for that determination. • Did/will the corrective action require modification of your SWPPP. Type in “Y” for yes and “N” for no. • Date Corrective action was initiated (mm/dd/yyyy) • Date corrective action was completed OR expected completion date (mm/dd/yyyy) <p>NOTE: If the corrective action has not been completed, enter an expected completion date. Do not put a date in both locations.</p> <p>If the corrective action has not been completed, provide the status of the corrective action and describe any remaining steps (including timeframes associated with each step) necessary to complete the corrective action.</p> <p>NOTE: This should only be filled out if the corrective action has not been completed. If the corrective action has been completed, enter “N/A.”</p> <p>Make sure to hit the “save” tab in the bottom right hand corner so the corrective action information is retained. If you want to enter more corrective actions, go back to the “Corrective Action Header” tab and press the “Enter New Corrective Action” button in the lower left hand corner of the screen (see step #2). Hitting the “Exit” button will cause you to exit from the system.</p>

	All boxes identified with a red asterisk are “required fields” and shall be filled out. If a date is not included or identified as an expected completion date, ENV-RCRA storm water compliance personnel will enter a completion date of 30 days after the corrective action was identified.
--	-----------------------------------------------------------------------------------------------------------------------------------------------------------------------------------------------------------------------------------------------------------------------------------------------

5.7 UPDATING CORRECTIVE ACTIONS

To update a corrective action in the ENV-RCRA MSGP Corrective Action Report Findings database, perform the following steps:

Step	Action
1	From this web page: http://int.lanl.gov/environment/water/guidance/swmgrp.shtml , under the heading “Compliance Tools”. Click on the link “ MSGP Corrective Action Report Findings Database ” to access the database and tab down to the corrective action number you want to edit. Click on “Edit.”
2	Navigate to the blank that you will be changing and input the updated information. It is anticipated that most changes will occur relative to updating the status of corrective actions. Save all changes to the information. Remember, you should only have a date under “Date corrective action completed OR the “expected to be completion,” but not both.

5.8 VALIDATING CORRECTIVE ACTIONS

ENV-RCRA storm water personnel will periodically validate the information contained in the ENV-RCRA MSGP Corrective Action Report Findings database. To validate a corrective action in the ENV-RCRA MSGP Corrective Action Report Findings database, perform the following steps:

Step	Action
1	From this web page: http://int.lanl.gov/environment/water/guidance/swmgrp.shtml , under the heading “Compliance Tools”. Click on the link “ MSGP Corrective Action Report Findings Database ” to access the database.

2	<p>Check all entered fields for a corrective action to ensure that all information is clear, correct, and concise. If not, correct the information by navigating to the information that needs to be changed and making the change. Save all changes to the information.</p> <p>All information shall be validated before running the final annual report.</p>
3	<p>For ENV-RCRA storm water personnel only, under “status” select “void” if the corrective action is a repeat of a previous corrective action or if it is determined not to be a corrective action. This will delete the corrective action from the annual report.</p>

5.9 INSTITUTIONAL PERFORMANCE FEEDBACK AND IMPROVEMENT TRACKING SYSTEM (PFITS)

PFITS is the institutional performance and tracking system for identified issues. A corrective action that meets any of the following criteria will be entered into the PFITS system, as deemed necessary.

- Corrective action was not completed by the expected completion date entered into the database.
- No action was taken to remedy an identified issue with a control measure within 14 days of discovery or before the next storm event or as soon as practicable following that storm event (Section 3.3 of the 2008 MSGP).
- Repeat corrective actions or trends identified by ENV-RCRA MSGP storm water personnel.
- Conditions requiring immediate action, where failure to take action would result in pollutants being released to water of the state or an immediate non-compliance with the 2008 MSGP.
- Violations identified by the regulatory authority.
- Other issues as deemed necessary by MSGP storm water personnel.

Once every month, ENV-RCRA storm water personnel will evaluate a summary of open corrective actions in the ENV-RCRA MSGP Corrective Action Report Findings database and using the above criteria will determine which corrective actions, if any, should be transferred into PFITS. When the monthly notification of outstanding corrective actions is sent out, evaluate whether any of the outstanding corrective actions meet the above conditions. Send those that do to the Environmental Protection Division’s Improvement Management Coordinator (IMC) so that she can enter the information into PFITS. The summary report will contain the following information, at a minimum:

- Date the corrective action was identified;
- Person that identified the corrective action;

Title: MSGP Storm Water Corrective Actions	No. ENV-RCRA-QP-022.2	Page 14 of 23
Effective Date: February 28, 2013		

- A description of the nature of the problem identified and what needs to be done to address the corrective action.
- Whether the corrective action was identified internal to LANL or External to LANL.

5.10 NOTIFICATIONS FOR NEW AND OVERDUE CORRECTIVE ACTIONS

When a new corrective action is entered into the ENV-RCRA MSGP Corrective Action Report Findings database, the FOD, ESH&Q Manager, Operations Manager, inspector (usually the DEP) and ENV-RCRA MSGP storm water personnel are notified automatically by e-mail (unless the corrective action is closed the same day it is entered). This will assist the FOD, ESH& Q Managers, Operations Managers and the DEPs with keeping track of new corrective actions.

An automatic e-mail is sent the first of each month notifying the FOD, ESH&Q Manager, Operations Manager and DEPs of all overdue corrective actions for their industrial facilities. The Environmental Protection Division Leader and ENV-RCRA Group Leader receive a web link that contains a bar graph showing corrective actions 30 to 60 days overdue, 60 to 90 days overdue, 90 days to 1 year overdue, and those greater than a year overdue. In addition, they receive a link with summary information on each corrective action overdue sorted by FOD.

6.0 REFERENCES

- Federal Register: *Final National Pollutant Discharge Elimination System (NPDES) General Permit for Storm Water Discharges from Industrial Activities*. Federal Register: September 29, 2008, Volume 73, Number 189.
- [P300, Integrated Work Management](#)
- [P315, Conduct of Operations Manual](#)
- [PD103, Worker Safety and Health Policy](#)
- [SD100, Integrated Safety Management System Description Document with Embedded 10 CFR 851 Worker Safety and Health Program](#)
- [P101-18, Procedure for Pause/Stop Work](#)
- [PD410, Los Alamos National Laboratory Environmental ALARA Program](#)
- [P121, Radiation Protection](#)
- [ENV-DO QP-106, Document Control](#)
- [ENV-DO-QP-115, Personnel Training](#)
- [ENV-DO-QP-104, Work Safety Review](#)

In addition to these documents, please read any site specific requirements before proceeding with work.

Title: MSGP Storm Water Corrective Actions	No. ENV-RCRA-QP-022.2	Page 15 of 23
Effective Date: February 28, 2013		

7.0 DEFINITIONS

Best Management Practice (BMP): Schedules of activities, prohibitions of practices, maintenance procedures, and other management practices to prevent or reduce the pollution of “waters of the United States.” BMPs also include treatment requirements, operating procedures, and practices to control plant site runoff, spillage or leaks, sludge or waste disposal, or drainage from raw material storage. (*40 CFR Part 122.2*)

Control Measure: Any BMP or other method (including effluent limitations) used to prevent or reduce the discharge of pollutants to waters of the United States.

CA: Corrective Action

DEP: Deployed Environmental Professional

EPA: Environmental Protection Agency

FOD: Facility Operations Director

MSGP: Multi-Sector General Permit

SWPPP: Storm Water Pollution Prevention Plan

8.0 ATTACHMENTS

Attachment 1- Annual Reporting Form

Attachment 2- NPDES Multi-Sector General Permit Routine Inspection Form

[Click here for “Required Read” credit.](#)

NPDES Permit Tracking No. _____

C. INDUSTRIAL ACTIVITY AREA SPECIFIC FINDINGS
Complete one block for each industrial activity area where pollutants may be exposed to stormwater. Copy this page for additional industrial activity areas.

In reviewing each area, you should consider:

- Industrial materials, residue, or trash that may have or could come into contact with stormwater;
- Leaks or spills from industrial equipment, drums, tanks, and other containers;
- Offsite tracking of industrial or waste materials from areas of no exposure to exposed areas; and
- Tracking or blowing of raw, final, or waste materials from areas of no exposure to exposed areas.

INDUSTRIAL ACTIVITY AREA _____:

1. Brief Description:

2. Are any control measures in need of maintenance or repair? YES NO

3. Have any control measures failed and require replacement? YES NO

4. Are any additional/revised control measures necessary in this area? YES NO

If YES to any of these three questions, provide a description of the problem: (Any necessary corrective actions should be described on the attached Corrective Action Form)

INDUSTRIAL ACTIVITY AREA _____:

1. Brief Description:

2. Are any control measures in need of maintenance or repair? YES NO

3. Have any control measures failed and require replacement? YES NO

4. Are any additional/revised c necessary in this area? YES NO

If YES to any of these three questions, provide a description of the problem: (Any necessary corrective actions should be described on the attached Corrective Action Form)

INDUSTRIAL ACTIVITY AREA _____:

Brief Description:

2. Are any control measures in need of maintenance or repair? YES NO

3. Have any control measures failed and require replacement? YES NO

4. Are any additional/revised BMPs necessary in this area? YES NO

If YES to any of these three questions, provide a description of the problem: (Any necessary corrective actions should be described on the attached Corrective Action Form)

NPDES Permit Tracking No. [] [] [] [] [] [] [] [] [] [] [] [] [] [] []

NOTE: Copy this page and attach additional pages as necessary

<p>INDUSTRIAL ACTIVITY AREA _____:</p> <p>1. Brief Description:</p> <p>2. Are any control measures in need of maintenance or repair? <input type="checkbox"/> YES <input type="checkbox"/> NO</p> <p>3. Have any control measures failed and require replacement? <input type="checkbox"/> YES <input type="checkbox"/> NO</p> <p>4. Are any additional/revised BMPs necessary in this area? <input type="checkbox"/> YES <input type="checkbox"/> NO</p> <p style="font-size: small;">If YES to any of these three questions, provide a description of the problem: (Any necessary corrective actions should be described on the attached Corrective Action Form)</p>
<p>INDUSTRIAL ACTIVITY AREA _____:</p> <p>1. Brief Description:</p> <p>2. Are any control measures in need of maintenance or repair? <input type="checkbox"/> YES <input type="checkbox"/> NO</p> <p>3. Have any control measures failed and require replacement? <input type="checkbox"/> YES <input type="checkbox"/> NO</p> <p>4. Are any additional/revised BMPs necessary in this area? <input type="checkbox"/> YES <input type="checkbox"/> NO</p> <p style="font-size: small;">If YES to any of these three questions, provide a description of the problem: (Any necessary corrective actions should be described on the attached Corrective Action Form)</p>
<p>INDUSTRIAL ACTIVITY AREA _____:</p> <p>1. Brief Description:</p> <p>2. Are any control measures in need of maintenance or repair? <input type="checkbox"/> YES <input type="checkbox"/> NO</p> <p>3. Have any control measures failed and require replacement? <input type="checkbox"/> YES <input type="checkbox"/> NO</p> <p>4. Are any additional/revised BMPs necessary in this area? <input type="checkbox"/> YES <input type="checkbox"/> NO</p> <p style="font-size: small;">If YES to any of these three questions, provide a description of the problem: (Any necessary corrective actions should be described on the attached Corrective Action Form)</p>

NPDES Permit Tracking No. [] [] [] [] [] [] [] [] [] [] [] [] [] [] []

D. CORRECTIVE ACTIONS

Complete this page for each specific condition requiring a corrective action or a review determining that no corrective action is needed. Copy this page for additional corrective actions or reviews.

Include both corrective actions that have been initiated or completed since the last annual report, and future corrective actions needed to address problems identified in this comprehensive stormwater inspection. Include an update on any outstanding corrective actions that had not been completed at the time of your previous annual report.

1. Corrective Action # [] [] of [] [] for this reporting period.

2. Is this corrective action:

- An update on a corrective action from a previous annual report, or
- A new corrective action?

3. Identify the condition(s) triggering the need for this review:

- Unauthorized release or discharge
- Numeric effluent limitation exceedance
- Control measures inadequate to meet applicable water quality standards
- Control measures inadequate to meet non numeric effluent limitations
- Control measures not properly operated or maintained
- Change in facility operations necessitated change in control measures
- Average benchmark value exceedance
- Other (describe): _____

4. Briefly describe the nature of the problem identified:

5. Date problem identified: [] / [] / [] [] [] [] [] [] []

6. How problem was identified:

- Comprehensive site inspection
- Quarterly visual assessment
- Routine facility inspection
- Benchmark monitoring
- Notification by EPA or State or local authorities
- Other (describe): _____

7. Description of corrective action(s) taken or to be taken to eliminate or further investigate the problem (e.g., describe modifications or repairs to control measures, analyses to be conducted, etc.) or if no modifications are needed, basis for that determination:

8. Did/Will this corrective action require modification of your SWPPP? YES NO

9. Date corrective action initiated: [] / [] / [] [] [] [] [] [] []

10. Date corrective action completed: [] / [] / [] [] [] [] [] [] [] or expected to be completed: [] / [] / [] [] [] [] [] [] []

11. If corrective action not yet completed, provide the status of corrective action at the time of the comprehensive site inspection and describe any remaining steps (including timeframes associated with each step) necessary to complete corrective action:

ATTACHMENT 2- NPDES MULTI-SECTOR GENERAL PERMIT ROUTINE INSPECTION FORM

NPDES Multi-Sector General Permit Routine Inspection Form (rev. 03/2009) Page 1 of 1 (Use additional sheets if necessary)

Los Alamos National Laboratory
ENV-RCRA

Name of Facility: _____

Responsible FOD (Name & Organization): _____

Inspection type: Quarterly Other _____

Date of Inspection (MM/DD/YYYY): _____

Time of Inspection: _____

Weather: Clear Cloudy Rain Fog Snow High Winds Other: _____

Temperature: _____ °F

#	Structural Control Measures (BMPs)	Location	Operating Effectively (Yes or No)?	If No, Need to Maintain (M), Repair (R) or Replace (RP)?	Corrective Action Needed and Notes (Identify needed maintenance and repairs, or any failed control measures that need replacement)
1.					
2.					
3.					
4.					
5.					
6.					
7.					
8.					
9.					
10.					
11.					
12.					

Were additional BMPs or Control Measures Implemented? Yes No Describe: _____

Were previously identified conditions corrected before the next anticipated storm event? Yes No If No, describe reason: _____

Area/Activity <small>(Areas of Inspecting Name(s) or Address, Classified by Class, Water)</small>	Inspected?	Controls Adequate?	Corrective Action Needed and Notes (List area letter with comments below)
A. Material loading/unloading & storage areas			
B. Equipment operations & maintenance areas			
C. Fueling Areas			
D. Outdoor vehicle & equipment washing areas			
E. Waste Handling & disposal areas			
F. Erosion areas / construction			
G. Non-storm water / illicit connections			
H. Salt storage piles or pile containing salt			
I. Dust generation & vehicle tracking			

Are the SWPP Plan maintenance, schedules and procedures being implemented at the facility? Yes No

Were any Corrective Actions Initiated or completed? Yes No Describe: _____

Are there any conditions requiring Corrective Action? Yes No If Yes, List Number of Corrective Actions Required _____

(Note – need a Corrective Action Form for each listed)

Title: MSGP Storm Water Corrective Actions	No. ENV-RCRA-QP-022.2 Page 23 of 23
Effective Date: February 28, 2013	

Los Alamos National Laboratory
ENV-RCRA

NPDES MWRI Sector General Permit Inspection Form
(rev. 03/2008) Certification Sheet

Non-Compliance

Describe any incidents of non-compliance and/or need for corrective action observed and not described above:

Additional Control Measures

Describe any additional control measures needed to comply with the permit requirements:

Notes

Use this space for any additional notes or observations from the inspection:

Inspector's Signature and date: _____

CERTIFICATION STATEMENT

"I certify under penalty of law that this document and all attachments were prepared under my direction or supervision in accordance with a system designed to assure that qualified personnel properly gathered and evaluated the information submitted. Based on my inquiry of the person or persons who manage the system, or those persons directly responsible for gathering the information, the information submitted is, to the best of my knowledge and belief, true, accurate, and complete. I am aware that there are significant penalties for submitting false information, including the possibility of fine and imprisonment for knowing violations."

Print name and title: _____

Signature: _____

Date: _____

MSGP STORM WATER VISUAL INSPECTIONS

Purpose This procedure is written to provide requirements for conducting visual monitoring under the 2008 National Pollutant Discharge Elimination System (NPDES) Storm Water Multi-Sector General Permit (MSGP) for industrial facilities.

Scope Requirements set forth in this document apply to Los Alamos National Laboratory industrial facilities covered by the MSGP. These facilities include, a warehouse, several metal fabrication areas/shops, a heavy equipment yard, an asphalt batch plant, roads and grounds, a foundry, a power plant, a material recycling facility and several hazardous waste treatment, storage or disposal (TSD) facilities. Inspection waivers may be granted by ENV-RCRA for adverse weather conditions and unstaffed or inactive sites.

Hazard review The work described in this procedure is field work and consists solely of visual evaluations, and has been documented to have a **LOW hazard** rating by submittal of a completed ENV Low Hazard Verification form to the Quality Assurance Specialist.

Signatures

Prepared by: <div style="text-align: center;">Signature on File</div> <hr/> Holly Wheeler, ENV-RCRA	Date: 02/22/12
Approved by: <div style="text-align: center;">Signature on File</div> <hr/> Melanie Lamb, ENV Quality Assurance Specialist	Date: 02/14/12
Authorized by: <div style="text-align: center;">Signature on File</div> <hr/> Terrill Lemke, ENV-RCRA Team Leader	Date: 02/27/12
Authorized by: <div style="text-align: center;">Signature on File</div> <hr/> Anthony Grieggs, ENV-RCRA Group Leader	Date**: 03/06/12
Classification Review by <div style="text-align: center;">Signature on File</div> <hr/> Anthony Grieggs, Derivative Classifier	Date: 03/06/12 <input checked="" type="checkbox"/> Unclassified

** Effective Date

CONTROLLED DOCUMENT

This copy is uncontrolled. The controlled copy can be found on the ENV Division Web page. Users are responsible for ensuring they work to the latest approved revision.

General information about this procedure

In this procedure

This procedure addresses the following major topics:

Topic	Page
General information about this procedure	2
Who requires training to this procedure?	2
Roles and responsibilities	5
Visual examinations	5
Completing the MSGP storm water visual inspection form	6
Guidance	8
Records resulting from this procedure	9

Attachments

This procedure has the following attachments:

Number	Attachment Title	No. of pages
1	MSGP Visual Inspection Form	1
2	Example MSGP Visual Inspection Form	1
3	Facilities and Storm Water Stations Associated With Industrial Activity	1

History of revision & review

This table lists the revision history, reviews, and effective dates of this procedure:

Revision	Date	Description of Changes or Review
0	7/09	New document.
1	3/10	Clarifications and added attachments.
2	2/12	Biennial review/revision.

Who requires training to this procedure?

The following personnel require training before implementing this procedure:

- Group and Project Leader
- MSGP Visual Assessors
- ENV-Deployed Environmental Professional (DEP)
- ENV-RCRA Sampling Team

Training method

Training to this procedure will be by “self-study” (reading) and will be documented in accordance with ENV-DO-QP-115 Personnel Training.

General information about this procedure, continued

Prerequisites In addition to training to this procedure, the following training is also required prior to performing this procedure:

- ENV-RCRA-QAPP-MSGP Multi-Sector General Permit Quality Assurance Project Plan

Definitions specific to this procedure Adverse weather conditions: Weather that prohibits collection of samples such as local flooding, high winds, hurricanes, tornadoes, electrical storms, etc. Could also include drought, extended frozen conditions, etc.

Best Management Practices (BMPs): Schedules of activities, practices, prohibitions of practices, structures, vegetation, maintenance procedures, and other management practices to prevent or reduce pollution. BMPs can also include treatment requirements, operating procedures, and practices to control facility site runoff, spillage or leaks, sludge or waste disposal, or drainage from raw material storage.

Clarity: Clearness or cleanness of appearance. This includes the visual observation of suspended sediment.

Color: Unpolluted water will be clear and colorless. Color should not be confused with clarity.

Floating solids: Particulate material floating on the surface of the water. Examples include: leaves, pinecones, pine needles, dead grass, twigs, branches, and common trash.

Foam: An accumulation of fine frothy bubbles formed in or on the surface of water. A mass of bubbles of air in a matrix of liquid film.

Odor: The property or quality of waters that affects or stimulates the sense of smell. Examples of odors that may be present are burnt oil, sewage, diesel, sulfuric, or detergent odors.

Oil sheen: The presence of rainbow-like colors glistening on the surface of a liquid. The color of oil sheen will vary dependent on thickness and consistency.

Settled solids: Settled particulate material i.e. heavier than water. Examples include sand, gravel, metal turnings, and glass.

Suspended solids: Particulate materials that are floating between the bottom of the sample and the surface of the water.

Unstaffed and Inactive Sites: A facility maintaining certification with the SWPPP that it is inactive and unstaffed and visual examinations are not required.

General information about this procedure, continued

References

- [Federal Register: Final National Pollutant Discharge Elimination System \(NPDES\) General Permit for Storm Water Discharges from Industrial Activities. Federal Register: September 29, 2008, Volume 73, Number 189.](#)
- [P300, Integrated Work Management for Work Activities](#)
- [P315, Laboratory Institutional Operations Program](#)
- [PD103, Worker Safety and Health Policy](#)
- [SD100, Integrated Safety Management System Description](#)
- [P101-18, Procedure for Pause/Stop Work](#)
- [PD410, Los Alamos National Laboratory Environmental ALARA Program P121 Radiation Protection](#)
- [ENV-DO-QP-106, Document Control](#)
- [ENV-DO-QP-102, Office Safety and Security](#)
- [ENV-DO-QP-104, Work Safety Review](#)
- [ENV-DO-QP-115, Personnel Training](#)

In addition to these documents, please read any site specific requirements before proceeding with work.

Note

Actions specified within this procedure, unless preceded with “should,” or “may,” are to be considered mandatory (i.e., “shall,” “must,” “will”).

Roles and Responsibilities

Deployed Environmental Professionals Deployed environmental professionals (DEPs) are responsible for collecting quarterly visual samples at substantially identical outfalls and completing required documentation, unless arrangements are made to use ENV-RCRA resources. DEPs will be fully knowledgeable of the site specific SWPPP. Whenever practicable the same person should carry out the inspection and examination of the discharges throughout the life of the permit to ensure consistency in interpretation of results. Further, DEPs shall be familiar with facility operations so that potential pollution discharge sources can be determined.

ENV-RCRA MSGP storm water compliance personnel MSGP storm water compliance personnel are responsible for filling out a visual assessment form if requested by work order for MSGP monitored outfalls. Storm water compliance personnel are also responsible for evaluating the quality of completed visual assessments, retaining a record of QA'd forms on the server and distributing these forms to the DEPs for inclusion into the appropriate facility SWPPP.

Visual Examinations

Visual examinations Visual examinations of storm water discharge shall be conducted quarterly for each discharge point covered by the MSGP and the site specific SWPPP.

Grab samples A grab sample will be collected during daylight hours in a 1 liter wide mouth clear glass bottle or plastic container within 30 minutes of discharge from a storm event. If it is not possible to collect the sample within the first 30 minutes of discharge, the sample must be collected as soon as practicable after the first 30 minutes. The sampler will document the reason a sample could not be collected within 30 minutes.

If no samples are collected because the sampler was not triggered (or for some other reason), documentation shall be kept in the facility's SWPPP explaining why visual examinations were not conducted.

Completing the MSGP Storm Water Visual Inspection Form

Location, date & time, inspector, etc. Complete the top section of form including location as indicated on site map, date and time, outfall ID (i.e. the monitored outfall), person collecting and examining the sample and signature, and inspection quarter.

NOTE: See Attachment 2 for an example of a filled-out MSGP Visual Inspection form.

NOTE: See Attachment 3 for facility name, location, and station numbers.

Include the date and time the discharge began, sample collection date and time and visual assessment date and time for each sample. Identify the nature of the discharge (i.e., rainfall or snowmelt). Determine whether it has been greater than 72 hours from the last storm event. If "No", explain when the last storm event occurred.

**Sample document-
ation**

Provide documentation if sample is not collected within 30 minutes of discharge.

Completing the MSGP Storm Water Visual Inspection Form, continued

**Describe
sample
parameters**

Refer to section 3.0, Definitions. See attachment 2 for an example of a filled-out MSGP Visual Inspection form.

Parameter	Description
Color	Describe the color of the discharge.
Odor	Describe any odors that may be observed in the discharge. Caution: any unusual odors should be documented.
Clarity	Clarity can be described as the depth in which you can look into or through water. For example an individual can see through a clear glass of clean water in daylight. Generally the clarity of the water is a good visual indicator of the purity of water. If the water is poor in clarity there is most likely suspended solids throughout the water.
Floating Solids	Note any floating solids in the sample. Careful examination should determine whether the solids are raw or waste materials (i.e. vegetative materials).
Settled Solids	Note any settled solids in the sample. Settled solids may be an indicator of unstable ground cover combined with a high intensity storm water runoff event.
Suspended Solids	Note any suspended solids in the sample. Most often suspended solids include fine sediment. This may be an indication of an unstable channel that may have eroding banks. Some water appears to be colored because of relatively coarse particulate material in suspension such as sediment.
Foam	Note an accumulation of fine frothy bubbles formed in or on the surface of water. Describe the color of the foam.
Oil Sheen	Note if there is an oil sheen present, the thickness, and consistency. If yes, contact the ENV-RCRA Project Leader for MSGP <u>immediately</u> . Follow-up action is required within 24 hours.
Other	Describe any other indicators of storm water pollution in addition to the descriptions mentioned above.

Completing the MSGP Storm Water Visual Inspection Form, continued

**ENV
Deployed
Environmental
Professional** Place completed and signed form into the facility SWPPP. Provide a copy to the MSGP Project Leader or other designee at ENV-RCRA.

**Site
observations** Note if there are any potential sources of pollutants on site. If yes, contact an MSGP representative of ENV-RCRA and document the following:

- potential sources;
- indicate if there are any BMPs on site and evaluate and note effectiveness;
- if no BMPs, determine if installation could correct future pollutant migration; and
- the nature of discharge (i.e., runoff or snow melt).

**Source of
pollutants** While conducting the visual examinations, personnel should constantly be attempting to relate any pollutant that is observed in the samples to the sources of pollutants that are on the site.

Guidance

Clean up A clean up of the site should be conducted if the pollutant source is known and well defined. The FOD, ESH Manager, and MSGP representative of ENV-RCRA should also be contacted and made aware of the situation. A design change could also be incorporated into the storm water pollution prevention plan to eliminate or minimize the contaminant source from occurring in the future. Personnel should evaluate whether or not additional BMPs should be implemented in the pollution prevention plan to address the observed contaminant, and if BMPs have already been implemented, evaluate whether or not these are working correctly or need maintenance. Corrective actions must be taken if BMPs are not performing effectively. Actions should be taken as soon as practicable from the discovery of any pollutants.

NOTE: This time frame (and those listed below) is not a grace period. Rather, it is a schedule considered reasonable for documenting your findings and for making repairs and improvements. The time frame is to ensure that the conditions prompting the need for these repairs and improvements are not allowed to persist indefinitely. Failure to take prompt action can result in fines and penalties for non-compliance.

Guidance, continued

Corrective action If storm water contamination is identified through visual assessment, a corrective action must be entered into the ENV-RCRA MSGP Corrective Action Report database within 24 hours of the observation. A corrective action plan must be identified within 14 days of the observation.

NOTE: If possible, the corrective action must be implemented before the next anticipated storm event.

Follow up A date for completion of implementation must be entered into the database to ensure that appropriate actions are taken in response to the examinations.

Records resulting from this procedure

Records The following records generated as a result of this procedure are to be submitted to an MSGP representative of ENV-RCRA in accordance with ENV-DO-QP-110 Records Management.

- MSGP Quarterly Visual Assessment Form
-

[Click here to record "self-study" training to this procedure.](#)

MSGP Quarterly Visual Assessment Form

Complete a separate form for each outfall you assess. When adverse weather conditions prevent the collection of a sample during the quarter, a substitute sample must be taken during the next qualifying storm event. Maintain this document in your SWPPP.

Name/Location of Facility:		Permit Number: NMR05GB21	Inspection Quarter: <input type="checkbox"/> Apr-May <input type="checkbox"/> Jun-Jul <input type="checkbox"/> Aug-Sep <input type="checkbox"/> Oct-Nov
Outfall ID:	"Substantially Identical Outfall"? <input type="checkbox"/> Yes <input type="checkbox"/> No	If YES identify other Outfalls in the Group:	
Person(s) collecting sample (PRINT):		Signature :	
PPT Member? <input type="checkbox"/> Yes <input type="checkbox"/> No			
Person(s) examining sample (PRINT):		Signature :	
PPT Member? <input type="checkbox"/> Yes <input type="checkbox"/> No			
Date & Time Discharge Began:	Date & Time Sample Collected:	Date & Time Sample Examined:	
Substitute Sample? <input type="checkbox"/> Yes <input type="checkbox"/> No		If YES, identify quarter/year when sample was originally scheduled to be collected:	
Was the sample collected in the first 30 minutes? <input type="checkbox"/> Yes <input type="checkbox"/> No If No, explain why not:			
Nature of Discharge: <input type="checkbox"/> Rainfall. Amount _____ inches <input type="checkbox"/> Snowmelt. Amount _____ inches			
Previous Storm Ended > 72 hours Before Start of This Storm? <input type="checkbox"/> Yes <input type="checkbox"/> No		If No, Explain: *	

PARAMETERS

Color	<input type="checkbox"/> None <input type="checkbox"/> Other	If Other describe:
Odor	<input type="checkbox"/> None <input type="checkbox"/> Musty <input type="checkbox"/> Sewage <input type="checkbox"/> Sulfur <input type="checkbox"/> Sour <input type="checkbox"/> Solvents <input type="checkbox"/> Petroleum/Gas <input type="checkbox"/> Other	If Other, describe the odor:
Clarity:	<input type="checkbox"/> Clear <input type="checkbox"/> Slightly Cloudy <input type="checkbox"/> Cloudy <input type="checkbox"/> Opaque <input type="checkbox"/> Other (describe):	
Floating Solids:	<input type="checkbox"/> Yes <input type="checkbox"/> No	If YES, describe if raw or waste materials(s):
Settled Solids:**	<input type="checkbox"/> Yes <input type="checkbox"/> No	If YES, are solids Fine <input type="checkbox"/> Coarse <input type="checkbox"/> If Other describe:
Suspended Solids:	<input type="checkbox"/> Yes <input type="checkbox"/> No	If YES, are solids Fine <input type="checkbox"/> Coarse <input type="checkbox"/> If Other describe:
Foam (gently shake sample):	<input type="checkbox"/> Yes <input type="checkbox"/> No	If YES, on the surface <input type="checkbox"/> or <input type="checkbox"/> in the water. Describe color:
Oil Sheen <input type="checkbox"/> Yes <input type="checkbox"/> No <input type="checkbox"/> Color of Sheen:	Thickness: Flecks <input type="checkbox"/> Globs <input type="checkbox"/> Describe if other:	
Other Obvious Indicators of Pollution Present in the sample? Yes <input type="checkbox"/> No <input type="checkbox"/>	If YES describe:	

SITE OBSERVATIONS

Potential pollutants found during visual examination? Yes No If Yes, list pollutant(s) and if possible indicate the source: If source is identified during collection of sample, please notify Tim Zimmerly @ 699-7621 or 664-0105

Pollutant	Source	Pollutant	Source

NOTE: A clean up of the site should be conducted if the pollutant source is known. Was proper Notification made? Yes No
 If Yes, indicate who was notified:

CORRECTIVE ACTION

If storm water contamination was identified in this sample through visual assessment, was a Corrective Action Form filled out within 24 hrs of observation? Yes No If No, explain why not:

Was a Corrective Action Plan identified within 14 days of the observation? Yes No If No, explain why not:

Other Relevant Information: Yes No

Use the back of this form to list any concerns, comments, and/or descriptions of pictures taken, (attach additional sheets as necessary).

* The 72-hour interval can be waived when the previous storm did not yield a measurable discharge or if you are able to document (attach applicable documentation) that less than a 72-hour interval is representative of local storm events during the sampling period.

** Observe for settled solids after allowing the sample to sit for approximately one-half hour.

Example of Filled-Out MSGP Quarterly Visual Assessment Form

MSGP Quarterly Visual Assessment Form			
Complete a separate form for each outfall you assess. When adverse weather conditions prevent the collection of a sample during the quarter, a substitute sample must be taken during the next qualifying storm event. Maintain this document in your SWPPP).			
Name/Location of Facility: TA-3-66 Sigma Foundry		Permit Number: NMR05GB21	Inspection Quarter: <input checked="" type="checkbox"/> Jan-Mar <input type="checkbox"/> Apr-Jun <input type="checkbox"/> Jul-Sep <input type="checkbox"/> Oct-Dec
Outfall ID: 3-Sigma-1	"Substantially Identical Outfall"? <input checked="" type="checkbox"/> Yes <input type="checkbox"/> No	If YES identify other Outfalls in the Group: 3-Sigma-2, 3-Sigma-3, 3-Sigma-4, 3-Sigma-5, 3-Sigma-6 and 3-Sigma-7	
Person(s) collecting sample (PRINT): PPT Member? <input type="checkbox"/> Yes <input checked="" type="checkbox"/> No Joe Doe		Signature: <i>Joe Doe</i>	
Person(s) examining sample (PRINT): PPT Member? <input type="checkbox"/> Yes <input checked="" type="checkbox"/> No Joe Doe		Signature: <i>Joe Doe</i>	
Date & Time Discharge Began: 1/14/2010 at 3:00 P.M.	Date & Time Sample Collected: 1/14/2010 at 3:25 P.M.	Date & Time Sample Examined: 1/14/2010 at 4:30 P.M.	
Substitute Sample? <input type="checkbox"/> Yes <input checked="" type="checkbox"/> No	If YES, identify quarter/year when sample was originally scheduled to be collected:		
Was the sample collected in the first 30 minutes? <input checked="" type="checkbox"/> Yes <input type="checkbox"/> No If No, explain why not:			
Nature of Discharge: <input type="checkbox"/> Rainfall. Amount _____ inches <input checked="" type="checkbox"/> Snowmelt. Amount 0.25 inches			
Previous Storm Ended > 72 hours Before Start of This Storm? <input checked="" type="checkbox"/> Yes <input type="checkbox"/> No		If No, Explain: *	
PARAMETERS			
Color <input type="checkbox"/> None <input checked="" type="checkbox"/> Other		If Other describe: light brown	
Odor <input checked="" type="checkbox"/> None <input type="checkbox"/> Musty <input type="checkbox"/> Sewage <input type="checkbox"/> Sulfur <input type="checkbox"/> Sour <input type="checkbox"/> Solvents <input type="checkbox"/> Petroleum/Gas <input type="checkbox"/> Other		If Other, describe the odor:	
Clarity: <input type="checkbox"/> Clear <input checked="" type="checkbox"/> Slightly Cloudy <input type="checkbox"/> Cloudy <input type="checkbox"/> Opaque <input type="checkbox"/> Other (describe):			
Floating Solids: <input type="checkbox"/> Yes <input checked="" type="checkbox"/> No		If YES, describe if raw or waste materials(s):	
Settled Solids:** <input type="checkbox"/> Yes <input checked="" type="checkbox"/> No		If YES, are solids Fine <input type="checkbox"/> Coarse <input type="checkbox"/> If Other describe:	
Suspended Solids: <input checked="" type="checkbox"/> Yes <input type="checkbox"/> No		If YES, are solids Fine <input checked="" type="checkbox"/> Coarse <input type="checkbox"/> If Other describe:	
Foam (gently shake sample): <input type="checkbox"/> Yes <input checked="" type="checkbox"/> No		If YES, on the surface <input type="checkbox"/> or <input type="checkbox"/> in the water. Describe color:	
Oil Sheen <input type="checkbox"/> Yes <input checked="" type="checkbox"/> No <input type="checkbox"/> Color of Sheen:		Thickness: Flecks <input type="checkbox"/> Globbs <input type="checkbox"/> Describe if other:	
Other Obvious Indicators of Pollution Present in the sample? Yes <input type="checkbox"/> No <input checked="" type="checkbox"/>		If YES describe:	
SITE OBSERVATIONS			
Potential pollutants found during visual examination? <input type="checkbox"/> Yes <input checked="" type="checkbox"/> No If Yes, list pollutant(s) and if possible indicate the source: If source is identified during collection of sample, please notify Tim Zimmerly @ 699-7621 or 664-0105			
Pollutant	Source	Pollutant	Source
NOTE: A clean up of the site should be conducted if the pollutant source is known. Was proper Notification made? <input type="checkbox"/> Yes <input type="checkbox"/> No If Yes, indicate who was notified:			
CORRECTIVE ACTION			
If storm water contamination was identified in this sample through visual assessment, was a Corrective Action Form filled out within 24 hrs of observation? Yes <input type="checkbox"/> No <input type="checkbox"/> If No, explain why not:			
Was a Corrective Action Plan identified within 14 days of the observation? Yes <input type="checkbox"/> No <input type="checkbox"/> If No, explain why not:			
Other Relevant Information: Yes <input type="checkbox"/> No <input checked="" type="checkbox"/> Use the back of this form to list any concerns, comments, and/or descriptions of pictures taken, (attach additional sheets as necessary).			
* The 72-hour interval can be waived when the previous storm did not yield a measurable discharge or if you are able to document (attach applicable documentation) that less than a 72-hour interval is representative of local storm events during the sampling period.			
** Observe for settled solids after allowing the sample to sit for approximately one-half hour.			

Los Alamos National Laboratory
FACILITIES AND STORM WATER STATIONS ASSOCIATED WITH INDUSTRIAL ACTIVITY
2008 MSGP PERMIT #NMR05GB21

LOCATION	OPERATION	Activity	Sector	STATION	DRAINAGE
TA-3-22	POWER PLANT	STEAM ELECTRIC POWER	O	E121.9, 03-0022N, 03-0022S	Sandia
TA-3-38	METAL SHOP	FABRICATED METALS	AA	03-0038W	Sandia
TA-3-39, 102	METAL SHOP	FABRICATED METALS	AA	03-0039E	Pajarito
TA-3-66	SIGMA FOUNDRY	PRIMARY METALS	F	E122.3	Sandia
TA-60	ASPHALT BATCH PLANT	ASPHALT BATCH PLANT	D	E200.5	Mortandad
TA-54	AREA G - South Side	TSD	K	54-PAD10E, E248.5, E248	Pajarito
TA-54	AREA G - North Side	TSD	K	E227	Canada del Buey
TA-54	AREA L	TSD	K	E223	Canada del Buey
TA-54-38	RANT	TSD	K	E220	Canada del Buey
TA-15-185	VEHICLE MAINTENANCE SHOP	VEHICLE MAINTENANCE	P	E262.4	Water
TA-60-1	MOTORPOOL	VEHICLE MAINTENANCE	P	60-0001	Sandia
TA-60	MATERIALS RECYCLING FACILITY	RECYCLING	N	E122.35	Sandia
TA-60-250	ROADS & GROUNDS FACILITY	VEHICLE MAINTENANCE & STORAGE	P	E123.4, 60-00RG, 60-00RGE	Sandia
TA-3-0034	METAL SHOP	FABRICATED METALS	AA	03-0034	Sandia
TA-9-28	HEAVY EQUIPMENT MAINTENANCE OPERATIONS	VEHICLE MAINTENANCE AND STORAGE	P	09-0028W	Upper Pajarito
TA-60-2	WAREHOUSE	WAREHOUSE	P	60-002E	Sandia